

KAYİTES
MÜHENDİSLİK

"Havalandırma Sanatı"

2024 Fiyat Listesi





Hakkımızda

Kayıtes Mühendislik 1992 yılında Konya'da kurulmuştur. Kurulduğu günden 2012 yılına kadar yurtiçi ve yurtdışında mekanik tesisat taahhüt işleri yapmış ve bu tarihten itibaren Kayı markasıyla havalandırma ekipmanları üretimi ve satışına başlamıştır. Mekanik tesisat işinde elde ettiğimiz 20 yıllık tecrübeyi müşterilerimize en iyi kalitede ürünleri sunmak için kullanıyoruz.

Görevimiz

"Kaliteli Hava"

Kayıtes olarak görevimiz havalandırma sektöründe yüksek kaliteli, yenilikçi doğaya ve insana önem veren ürünler üretmek, çözüm ortaklarımızın faydalarını gözetmek, koşulsuz müşteri memnuniyeti sağlamak ve kurumsal olarak sürekli öğrenmektir.

Amacımız

Havalandırma sektöründe ülkemizde ve dünyada müşterilerin tercihi olan bir marka olmak, çevrenin korunması için teknolojinin elverdiği en yüksek enerji verimliliğine sahip ürünler üretmek, yüksek istihdam değerlerine ulaşmak, ülkemizin ekonomisine katkıda bulunmaktır.

Değerlerimiz

Müşteri memnuniyeti, insana ve insan sağlığına saygı, çevreyi korumak, kalite, dürüstlük ve yenilikçilik.

Kalite politikamız

Dünyada kabul görmüş kalite, çevre, iş sağlığı ve güvenliği standartlarının gerekliliklerini yerine getirmek, üretimde "sıfır hata" politikasıyla müşteri memnuniyetini sağlamak ve şirket içi verimliliği sürekli arttırmak



Banka Bilgileri

Garanti Bankası (TL) : TR76 0006 2000 4190 0006 2884 84
Türkiye İş Bankası (TL) : TR31 0006 4000 0014 5140 0729 54
Ziraat Bankası (TL) : TR80 0001 0020 8758 9345 6650 03

ÜNVAN: Kayı-tes Mühendislik Taahhüt İletişim Elektronik ve Dayanıklı Tüketim Malları Sanayi Ticaret Limited Şirketi

ADRES: Aslım Caddesi No:42/C Karatay 42050 KONYA - TÜRKİYE

TELEFON: +90 (332) 345 36 76 **FAKS:** +90 (332) 345 36 77

VERGİ DAİRESİ: SELÇUK **VERGİ NO:** 538 0016 000

MERSİS NO: 05380016000000014 **KEP ADRESİ:** kayi-tes@hs05.kep.tr

Fiyatlarımıza K.D.V. ve NAKLİYE Dahil Değildir.

KAYITES Mühendislik kataloğtaki fiyatları haber vermeksizin değiştirme hakkını saklı tutar. Tasarımdan doğabilecek grafik, dizgi, ve fiyatlandırma hatalarından firmamız sorumlu değildir.

	JAXIF3 F300 Aksiyel Jet Fan	11
	JAXIF4 F400 Aksiyel Jet Fan	12
	JRADF3 F300 Radyal Jet Fan	13
	JRADF4 F400 Radyal Jet Fan	14
	AXI Aksiyel Basınçlandırma Fanı	15
	AXI AXI - 2P Yüksek Devirli Aksiyel Basınçlandırma Fanı	19
	TAXIF3 F300 Aksiyel Duman Egzoz Fanı	22
	TAXIF3 F300-2P Yüksek Devirli Aksiyel Duman Egzoz Fanı	26
	TAXIF4 F400 Aksiyel Duman Egzoz Fanı	29
	PAXI Exproof Motorlu Aksiyel Fan	33
	HAXI Hücreli Aksiyel Fan	37
	DAXI Dıştan Motorlu Kayış-Kasnaklı Aksiyel Fan	41
	BAXI Saklı Motorlu Aksiyel Fan	45
	GAXI Mobil Aksiyel Fan	49
	AXIP Plastik Kanatlı Duvar Tipi Aksiyel Fan	51
	CAXI Çatı Tipi Yatay Atışlı Aksiyel Fan	55

içindekiler



	CTAXIF3	59
	CTAXIF4	63
	CAXIDIK	67
	KMF	70
	SOF	71
	AXIS	73
	DAXIS	75
	KDAXIS	77
	KAP	79
	KAF	81
	RAD	83
	REC	85
	CUB	89
	DREC	93
	MEF	95
	HMEF	97

İçindekiler



	KASP Aktif Karbon Filtreli Mutfak Egzoz Fanı	101
	HASP Hücreli Fan	103
	EC-CRAD EC Motorlu Çatı Tipi Yatay Atışlı Radyal Fan	107
	CRAD Çatı Tipi Yatay Atışlı Radyal Fan	109
	CRADIK Çatı Tipi Dikey Atışlı Radyal Fan	113
	MRAD Dıştan Motorlu Çatı Tipi Monofaze Fan	117
	DRAD Dıştan Motorlu Çatı Tipi Yatay Atışlı Radyal Fan	119
	DRADIK Dıştan Motorlu Çatı Tipi Dikey Atışlı Radyal Fan	121
	SAL Salyangoz Fan	123
	KAZ Alüminyum Gövdeli Salyangoz Fan	127
	IGK Isı Geri Kazanım Cihazı	129
	SHU Sığınak Havalandırma Ünitesi	133
	FFU Filtreli Fan	137
	FFUH Hepa Filtreli Fan	139
	HTUY Yer Tipi Hava Temizleme Ünitesi	141

İçindekiler

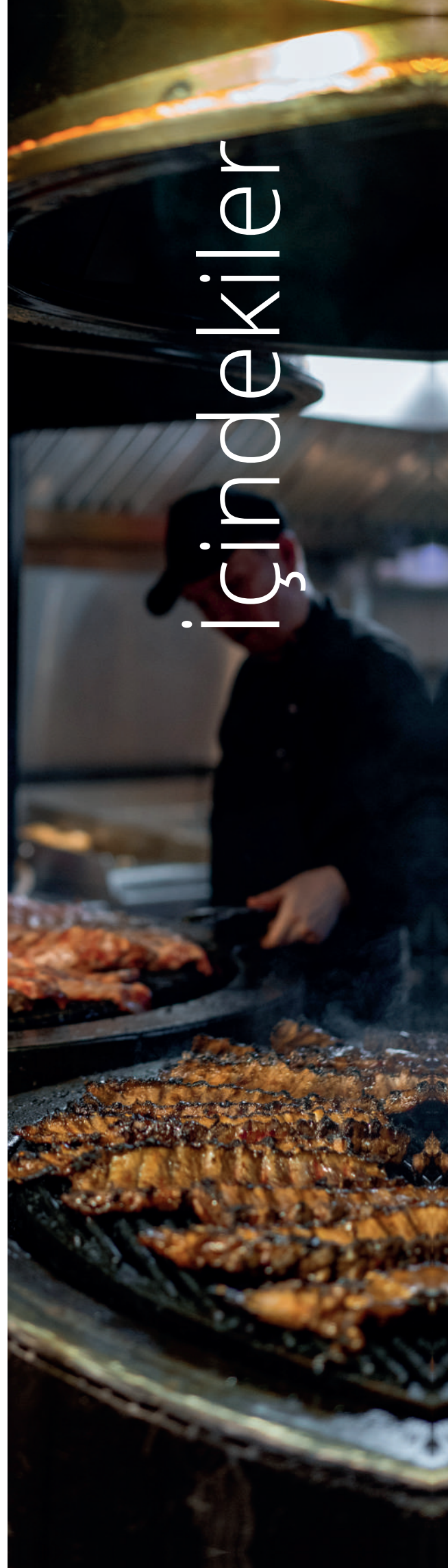



HTUT

Tavan Tipi Hava Temizleme Ünitesi

143



HFFU

Hijyenik Filtreli Fan

145



BAF

Banyo Fanı

147



SEF

Sessiz Banyo Fanı

149



YUF

Yuvarlak Banyo Fanı

151



CFD-VFD

Fan Kontrol Cihazları

153



SER

Sera Fanı

155



TAV

Çiftlik Fanı

156



GEMİCİ ANEMOSTADLAR

Gemici Anemostadlar

158



SUSTURUCU

Prizmatik ve Yuvarlak Susturucu

159



QCM-ATX

Duvar Tipi Aksiyel ATEX Fan

160



ERM-EX

Kanal Tipi Plastik ATEX Fan

162



VITRO

Cam Tipi Panjurlu Fan

164



SAF

Asitli Ortam Fanı

165

İçindekiler



► PRATİK BİLGİLER

HAVALANDIRMA HESABI

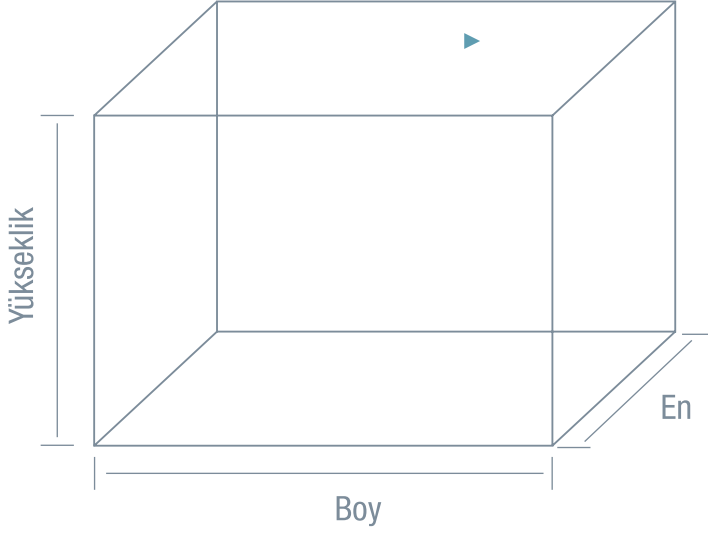

Hacim (V) = en(a) x boy(b) x yükseklik(h)

Debi = V x k

k : Hava değişim katsayısı

Basit havalandırma hesabı için önce havalandırılacak yerin hacmi hesap edilir. Hacim ile hava değişim katsayısı çarpılarak debi hesabı yapılır. Hava değişim katsayıları havalandırılacak yere göre değişkenlik göstermektedir. Aşağıdaki tabloda hava değişim katsayıları verilmiştir.

Ayrıca havalandırılacak mekanlarda kişi başına 30-60 m³/h taze havayı ortama vermek gerekmektedir. Kişi sayısı ile kişi başına taze hava miktarını çarpılarak toplam taze hava miktarını hesap ederiz

► HAVA DEĞİŞİM KATSAYISI TABLOSU

MEKAN	HAVA DEĞİŞİM KATSAYISI	MEKAN	HAVA DEĞİŞİM KATSAYISI
Banka	8 - 10	Labaratuar	4 - 6
Boyahane	30 - 60	Lokanta	6 - 10
Çamaşırhane	20 - 30	Ofis	6 - 10
Dershane	6 - 10	Otopark	9 - 10
Dökümhane	20 -30	Sanayi Mutfağı	15 - 20
Düğün Salonu	10 - 15	Sinema	10 - 15
Et - Yumurta Deposu	10 - 20	Spor Salonu	8 - 10
Ev Mutfağı	10 - 15	Tiyatro	10 - 15
Fabrika	6 - 10	Toplantı Salonu	6 - 10
Hastane	4 - 6	Tuvalet	10 - 15
Kafe	10 - 12	Yüzme Havuzu	20 -30
Konut	1 - 2		

HAVA KANALI KESİT HESABI

Kanal kesit hesabı yapılırken iki farklı metod uygulanabilir.

1 - HIZ YÖNTEMİ

Bu metod uygulanırken kanal boyunca uygun hızlar takdir edilir. Bu hız konfor uygulamalarında cihaz çıkışında 6 m/sn'den başlayıp, kanal sonlarına doğru 3 m/sn hızlara kadar düşer. Hava kanalı hesap cetvelinden kanaldan geçen debiyi ve seçtiğimiz hızı karşılaştırıyoruz. Yukarıdaki örnekte 10.000 m³/h debi ile 5 m/sn hızı karşıştırınca kanal kesiti 90 cm x 60 cm çıkmaktadır. Burada kanal kesitinde genişlik / yükseklik oranı 3/1 den fazla olmamalıdır.

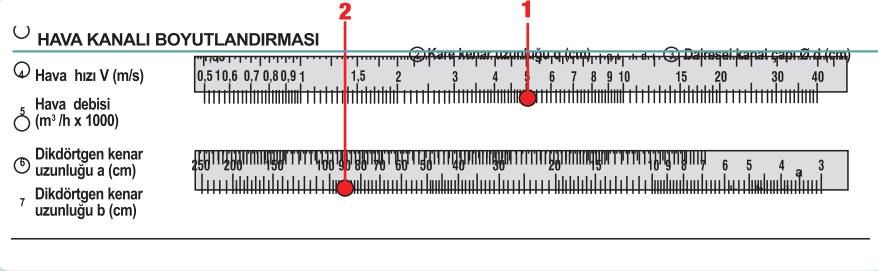

2- EŞ DEĞER SÜRTÜNME KAYBI YÖNTEMİ

Bu methodda her bir metre kanal için basınç kaybı belirlenir ve bu basınç kaybına göre hava kanalı çapı tayini yapılır. Basınç kaybı 0.70 Pa/m ile 1 Pa/m arasında belirlenebilir. Aşağıdaki örnekte 4.000 m³/h debi için 0.70 Pa/m basınç kaybına göre hava kanalı çapı 52 cm çıkmaktadır.

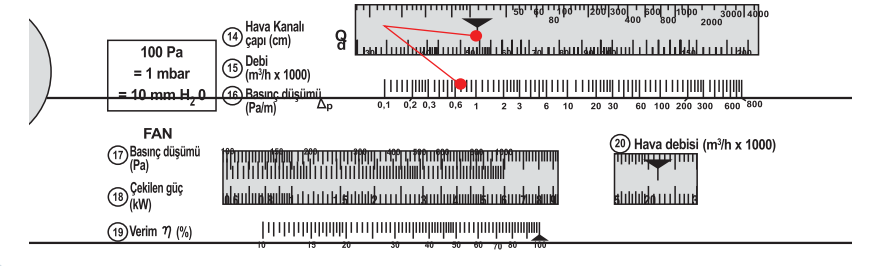

Hesap cetvelinin diğer yüzünden 52 cm yuvarlak kanala tekabül eden dikdörtgen kesitli kanalı 50 cm x 40 cm olarak tespit edebiliriz. Tüm kanal boyunca aynı metodu uygulayabiliriz.

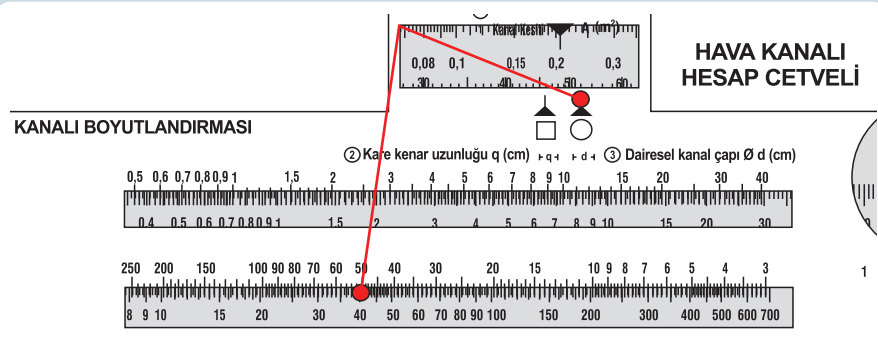

PRATİK BİLGİLER

DAVLUMBAZ ASPIRATÖRÜ HESABI

Bu yöntemde, davlumbazın açık yanları ve tezgaha olan uzaklığı kullanılarak gereken minimum hava debisi bulunur.

Debi= Davlumbazın Emiş Yapabileceği Uzunluk x Davlumbazın Tezgaha Olan Uzaklığı x Yakalama Hızı

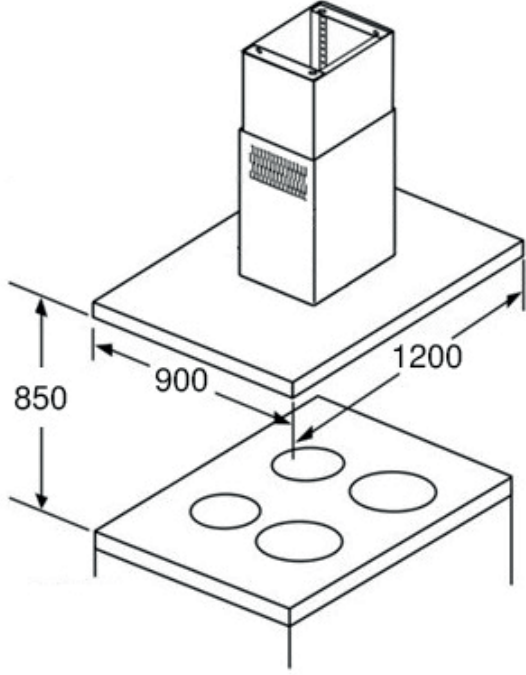

Yukarıda verilmiş olan ada tipi davlumbazın debi hesabı aşağıdaki gibi yapılır.

Davlumbazın Emiş Yapabileceği Uzunluk =
900+900+1200+1200 = 4200 mm = 4,2 m

Davlumbazın Tezgaha Olan Uzaklığı = 850 mm = 0,85 m

Yakalama Hızı = 0,15 m/s (Genel Kabul)

Debi = 4,2 m x 0,85 m x 0,15 m/s x 3600 s/saat

Debi = 1928 m³/h

Bulunan bu debi minimum debi olup, ortam şartları, ortamda çalışan mutfak ekipmanları ve havalandırma sistemlerine göre bu değerın üstünde bir fan seçilebilir.

► JAXI - Aksiyel Jet Fan - F300

Jet fanlar otopark havalandırmalarında kullanılmak için tasarlanmış, havanın kanallar boyunca taşınmasına daha verimli bir alternatiftir. Taşımak yerine havayı boşlukta ittiği için, kanallı sistemdeki sürtünme kayıplarına uğramaz. Diğer sistemlere engel olmaz, kolay montajlanır ve otomasyona uygundur.



MOTOR YALITIM SINIFI	H SINIFI
MOTOR KORUMA SINIFI	IP 54-IP 55
MOTOR VERİM SINIFI	IE1-IE2
MOTOR TİPİ	TEAO
MOTOR MARKASI	-
GÖVDE MALZEMESİ	GALVANİZE SAC
GÖVDE KAPLAMASI	YOK
PERVANE MALZEMESİ	ALÜMİNYUM
GÖREV DÖNGÜSÜ	IEC Duty Cycle-S1
ÇALIŞMA SICAKLIĞI	-20 - +50 °C
STANDARTLAR	IEC-60335-2-80, ISO 1940-1



MODEL	DEBİ (m³/h)	HAVA HIZI (m/s)	İTME KUVVETİ (N)	DEVİR (d/dk)	MOTOR GÜCÜ (kW)	SES SEVİYESİ (dB(A)-1m)	FİYAT (€/Adet)
JAXI 315	2.320 - 4.640	8,3 - 16,6	6 - 24	1.450 - 2.900	0,20 - 0,80	71 - 85	986,00 €
JAXI 355	3.360 - 6.720	9,4 - 18,8	10 - 40	1.450 - 2.900	0,37 - 1,50	74 - 87	1.119,00 €
JAXI 400	4.835 - 9.670	10,7 - 21,4	17 - 68	1.450 - 2.900	0,50 - 2,20	76 - 90	1.217,00 €
JAXI 450	6.745 - 13.490	11,8 - 23,6	26 - 104	1.450 - 2.900	0,80 - 3,10	79 - 93	1.509,00 €
JAXI 500	8.950 - 17.900	12,7 - 25,4	38 - 152	1.450 - 2.900	1,10 - 4,40	81 - 95	1.779,00 €

OPSİYONLAR



- SİSTEM OTOMASYONU
- ÇİFT YÖNLÜ ÇALIŞABİLEN FAN
- CFD ANALİZİ

DEFLEKTÖR	
ÖLÇÜ	FİYAT
315	107,00 €
355	122,00 €
400	128,00 €
450	158,00 €
500	188,00 €

TEKNİK RESİM

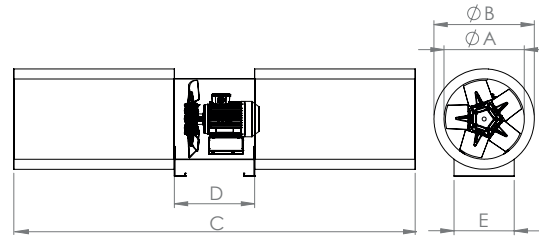

MODEL	A (mm)	B (mm)	C (mm)	D (mm)	E (mm)
JAXI 315	315	415	2000	400	300
JAXI 355	355	455	2000	400	330
JAXI 400	400	500	2000	400	350
JAXI 450	450	550	2000	400	450
JAXI 500	500	600	2000	400	450

► JAXI - Aksiyel Jet Fan - F400



Jet fanlar otopark havalandırmalarında kullanılmak için tasarlanmış, havanın kanallar boyunca taşınmasına daha verimli bir alternatiftir. Taşımak yerine havayı boşlukta ittiği için, kanallı sistemdeki sürtünme kayıplarına uğramaz. Diğer sistemlere engel olmaz, kolay montajlanır ve otomasyona uygundur.



MOTOR YALITIM SINIFI	H SINIFI
MOTOR KORUMA SINIFI	IP 54-IP 55
MOTOR VERİM SINIFI	IE1-IE2
MOTOR TIPI	TEAO
MOTOR MARKASI	-
GÖVDE MALZEMESİ	GALVANİZE SAC
GÖVDE KAPLAMASI	YOK
PERVANE MALZEMESİ	ALÜMİNYUM
GÖREV DÖNGÜSÜ	IEC Duty Cycle-S1
ÇALIŞMA SICAKLIĞI	-20 - +50 °C
STANDARTLAR	IEC-60335-2-80, ISO 1940-1

MODEL	DEBİ (m³/h)	HAVA HIZI (m/s)	İTME KUVVETİ (N)	DEVİR (d/dk)	MOTOR GÜCÜ (kW)	SES SEVİYESİ (dB(A)-1m)	FIYAT (€/Adet)
JAXI 315	2.320 - 4.640	8,3 - 16,6	6 - 24	1.450 - 2.900	0,20 - 0,80	71 - 85	2.100,00 €
JAXI 355	3.360 - 6.720	9,4 - 18,8	10 - 40	1.450 - 2.900	0,37 - 1,50	74 - 87	2.300,00 €
JAXI 400	4.835 - 9.670	10,7 - 21,4	17 - 68	1.450 - 2.900	0,50 - 2,20	76 - 90	2.600,00 €
JAXI 450	6.745 - 13.490	11,8 - 23,6	26 - 104	1.450 - 2.900	0,80 - 3,10	79 - 93	3.100,00 €
JAXI 500	8.950 - 17.900	12,7 - 25,4	38 - 152	1.450 - 2.900	1,10 - 4,40	81 - 95	3.600,00 €

OPSİYONLAR



- SİSTEM OTOMASYONU
- ÇİFT YÖNLÜ ÇALIŞABİLEN FAN
- CFD ANALİZİ

DEFLEKTÖR

ÖLÇÜ	FIYAT
315	107,00 €
355	122,00 €
400	128,00 €
450	158,00 €
500	188,00 €

TEKNİK RESİM

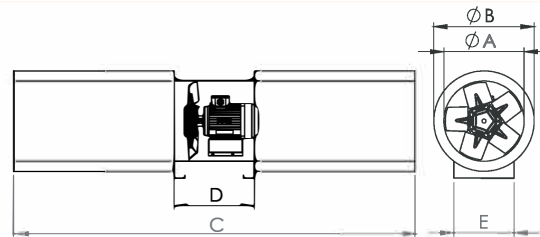

MODEL	A (mm)	B (mm)	C (mm)	D (mm)	E (mm)
JAXI 315	315	415	2000	400	300
JAXI 355	355	455	2000	400	330
JAXI 400	400	500	2000	400	350
JAXI 450	450	550	2000	400	450
JAXI 500	500	600	2000	400	450

► JRAD - Radyal Jet Fan - F300

Radyal Jet Fan'lar düşük profili sayesinde kot problemi yaşanan otoparklarda kullanılabilir.



MOTOR YALITIM SINIFI	H SINIFI
MOTOR KORUMA SINIFI	IP 54-IP 55
MOTOR VERİM SINIFI	IE1-IE2
MOTOR TİPİ	TEAO
MOTOR MARKASI	-
GÖVDE MALZEMESİ	GALVANİZE SAC
GÖVDE KAPLAMASI	YOK
PERVANE MALZEMESİ	GALVANİZE SAC
GÖREV DÖNGÜSÜ	IEC Duty Cycle-S1
ÇALIŞMA SICAKLIĞI	-20 - +50 °C
STANDARTLAR	IEC-60335-2-80, ISO 1940-1

MODEL	DEBİ (m³/h)	HAVA HIZI (m/s)	İTME KUVVETİ (N)	DEVİR (d/dk)	MOTOR GÜCÜ (kW)	SES SEVİYESİ (dB(A)-1m)	FİYAT (€/Adet)
JRAD 50	2.850 - 5.760	10,0 - 20,0	13 - 50	750 - 1500	0,30 - 1,20	38 - 54	1.145,00 €
JRAD 70	3.500 - 7.009	12,2 - 24,4	19 - 70	750 - 1500	0,55 - 2,20	43 - 58	1.432,00 €
JRAD 90	3.800 - 7.641	13,3 - 26,6	25 - 90	750 - 1500	0,55 - 2,20	46 - 62	1.483,00 €

OPSİYONLAR

- SİSTEM OTOMASYONU
- CFD ANALİZİ

TEKNİK RESİM

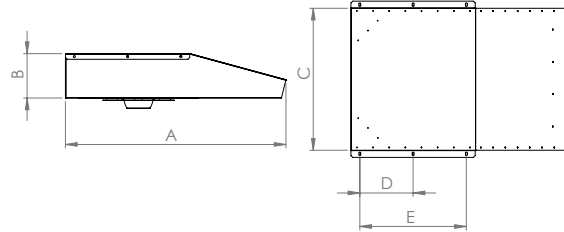

MODEL	A (mm)	B (mm)	C (mm)	D (mm)	E (mm)
JRAD 50	1215	250	800	300	600
JRAD 70	1300	300	840	300	600
JRAD 90	1300	300	840	300	600

► JRAD - Radyal Jet Fan - F400

Radyal Jet Fan'lar düşük profili sayesinde kot problemi yaşanan otoparklarda kullanılabilir.



MOTOR YALITIM SINIFI	H SINIFI
MOTOR KORUMA SINIFI	IP 54-IP 55
MOTOR VERİM SINIFI	IE1-IE2
MOTOR TİPİ	TEAO
MOTOR MARKASI	-
GÖVDE MALZEMESİ	GALVANİZE SAC
GÖVDE KAPLAMASI	YOK
PERVANE MALZEMESİ	GALVANİZE SAC
GÖREV DÖNGÜSÜ	IEC Duty Cycle-S1
ÇALIŞMA SICAKLIĞI	-20 - +50 °C
STANDARTLAR	IEC-60335-2-80, ISO 1940-1

MODEL	DEBİ (m³/h)	HAVA HIZI (m/s)	İTME KUVVETİ (N)	DEVİR (d/dk)	MOTOR GÜCÜ (kW)	SES SEVİYESİ (dB(A)-1m)	FİYAT (€/Adet)
JRAD 50	2.850 - 5.760	10,0 - 20,0	13 - 50	750 - 1500	0,30 - 1,20	38 - 54	2.600,00 €
JRAD 70	3.500 - 7.009	12,2 - 24,4	19 - 70	750 - 1500	0,55 - 2,20	43 - 58	3.300,00 €
JRAD 90	3.800 - 7.641	13,3 - 26,6	25 - 90	750 - 1500	0,55 - 2,20	46 - 62	3.500,00 €

OPSİYONLAR

- SİSTEM OTOMASYONU
- CFD ANALİZİ

TEKNİK RESİM

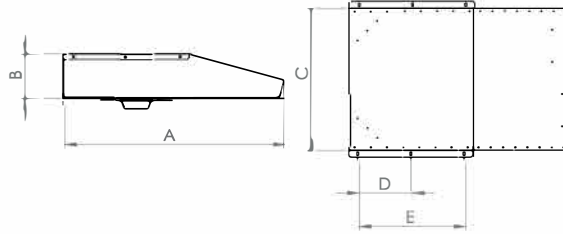

MODEL	A (mm)	B (mm)	C (mm)	D (mm)	E (mm)
JRAD 50	1215	250	800	300	600
JRAD 70	1300	300	840	300	600
JRAD 90	1300	300	840	300	600

► AXI - Aksiyel Basınçlandırma Fanı

Aksiyel basınçlandırma fanları merdiven, asansör boşluğu vb. gibi basınçlandırma ihtiyaçlarını karşılamak için kullanılabilir. Kanallı sistemlerle yüksek debi ihtiyacı olan projelerde kullanılabilir.



MOTOR YALITIM SINIFI	F SINIFI
MOTOR KORUMA SINIFI	IP 55
MOTOR VERİM SINIFI	IE3
MOTOR TİPİ	TEFC
MOTOR MARKASI	-
GÖVDE MALZEMESİ	GALVANİZE SAC
GÖVDE KAPLAMASI	YOK
PERVANE MALZEMESİ	ALÜMİNYUM
GÖREV DÖNGÜSÜ	IEC Duty Cycle-S1
ÇALIŞMA SICAKLIĞI	-20 - +50 °C
STANDARTLAR	IEC-60335-2-80, ISO 1940-1



MODEL	VOLTAJ (V)	FREKANS (Hz)	GÜÇ (kW)	DEVİR (d/dk)	DEBİ (m³/h)	SES SEVİYESİ (dB(A))	FİYAT (€/Adet)
AXI 400-5-25	380	50	0,37	1.450	2.895	66	368,00 €
AXI 450-5-25	380	50	0,55	1.456	4.180	69	427,00 €
AXI 500-5-25	380	50	0,55	1.453	5.845	72	465,00 €
AXI 560-5-25	380	50	0,75	1.466	8.150	75	527,00 €
AXI 630-5-30	380	50	1,10	1.465	13.480	80	596,00 €
AXI 710-5-30	380	50	1,50	1.472	19.210	83	707,00 €
AXI 800-5-30	380	50	2,20	1.459	25.560	85	836,00 €
AXI 800-5-35	380	50	3,00	1.463	30.940	89	921,00 €
AXI 900-5-35	380	50	4,00	1.471	39.250	90	1.093,00 €
AXI 900-5-40	380	50	5,50	1.472	44.635	93	1.354,00 €
AXI 1000-5-40	380	50	7,50	1.478	54.570	94	1.525,00 €
AXI 900-8-40	380	50	11,00	1.454	46.200	94	2.207,00 €
AXI 1000-8-40	380	50	15,00	1.456	62.250	97	2.502,00 €
AXI 1000-8-45	380	50	18,50	1.458	69.070	99	2.931,00 €
AXI 1120-8-40	380	50	22,00	1.471	86.620	100	3.699,00 €
AXI 1120-8-45	380	50	30,00	1.474	95.270	102	4.089,00 €

Değerler 0 Pa içindir

OPSİYONLAR



KORUMA TELİ		MONTAJ AYAĞI		KARŞI FLANŞ		KONNEKTÖR		TAKOZ		YAY		PANO	
ÖLÇÜ	FİYAT	ÖLÇÜ	FİYAT	ÖLÇÜ	FİYAT	ÖLÇÜ	FİYAT	ÖLÇÜ	FİYAT	ÖLÇÜ	FİYAT	ÖLÇÜ	FİYAT
400	30,00 €	400	27,00 €	400	48,00 €	400	107,00 €	400	48,00 €	400	142,00 €	5,5 kW	570,00 €
450	30,00 €	450	30,00 €	450	52,00 €	450	118,00 €	450	48,00 €	450	142,00 €	7,5 kW	570,00 €
500	37,00 €	500	33,00 €	500	58,00 €	500	130,00 €	500	48,00 €	500	142,00 €	11,0 kW	570,00 €
560	39,00 €	560	37,00 €	560	63,00 €	560	142,00 €	560	48,00 €	560	142,00 €	15,0 kW	970,00 €
630	45,00 €	630	43,00 €	630	69,00 €	630	157,00 €	630	48,00 €	630	142,00 €	18,5 kW	970,00 €
710	60,00 €	710	54,00 €	710	78,75 €	710	179,00 €	710	64,00 €	710	192,00 €	22,0 kW	1.675,00 €
800	75,00 €	800	69,00 €	800	93,00 €	800	207,00 €	800	64,00 €	800	192,00 €	30,0 kW	1.675,00 €
900	94,00 €	900	85,00 €	900	99,00 €	900	222,00 €	900	64,00 €	900	192,00 €		
1000	142,00 €	1000	127,00 €	1000	107,00 €	1000	248,00 €	1000	64,00 €	1000	192,00 €		
1120	163,00 €	1120	148,00 €	1120	124,00 €	1120	279,00 €	1120	64,00 €	1120	192,00 €		

DIĞER OPSİYONLAR



İstenilen Renkte Elektro-Statik Toz Boya



Alüminyum veya Plastik Kanat Seçeneği



İstenilen Debi ve Basınca Özel Üretim



Sistem Otomasyonu



5, 8, 12 ve 16 Kanat Adedi Seçenekleri

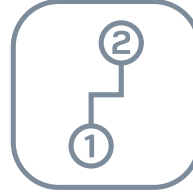

Çift Devirli Motor Seçeneği

TEKNİK RESİM

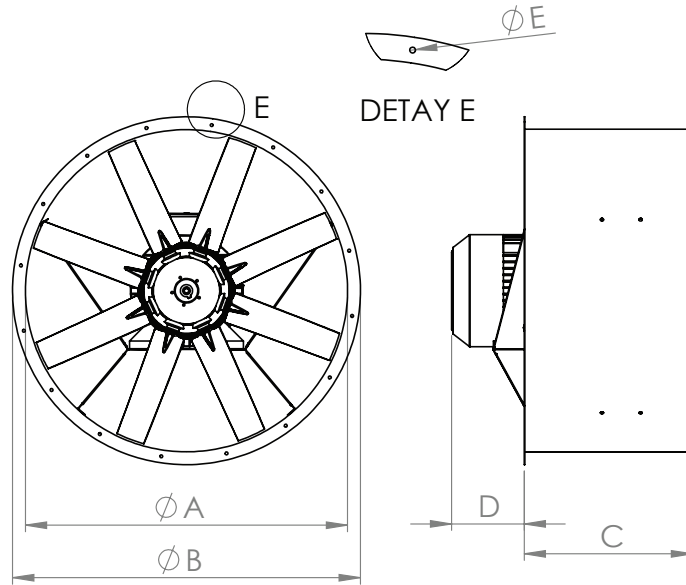

MODEL	A (mm)	B (mm)	C (mm)	D (mm)	E (mm)	N (Delik Sayısı)
AXI 400-5-25	400	480	320	30	11	8
AXI 450-5-25	450	530	320	50	11	8
AXI 500-5-25	500	580	320	70	11	8
AXI 560-5-25	560	640	320	60	11	12
AXI 630-5-30	630	710	420	45	11	12
AXI 710-5-30	710	790	420	25	11	12
AXI 800-5-30	800	880	420	50	11	16
AXI 800-5-35	800	880	420	50	11	16
AXI 900-5-35	900	980	520	0	11	16
AXI 900-5-40	900	980	520	35	11	16
AXI 1000-5-40	1000	1080	520	150	11	16
AXI 900-8-40	900	980	520	75	11	16
AXI 1000-8-40	1000	1080	520	180	11	16
AXI 1000-8-45	1000	1080	520	250	11	16
AXI 1120-8-40	1120	1200	800	250	11	16
AXI 1120-8-45	1120	1200	800	300	11	16

PERFORMANS EĞRİLERİ

AXI 400-5-25

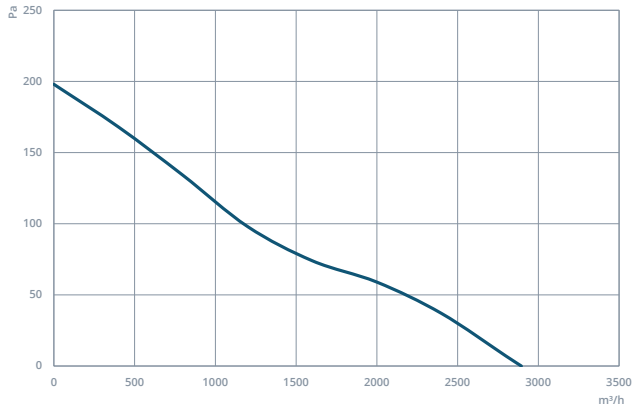

AXI 450-5-25

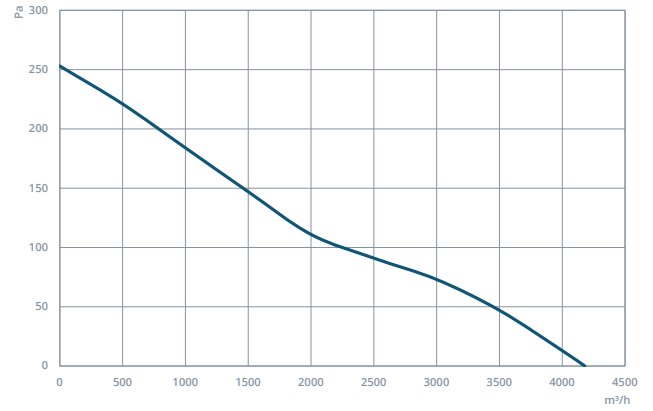

AXI 500-5-25

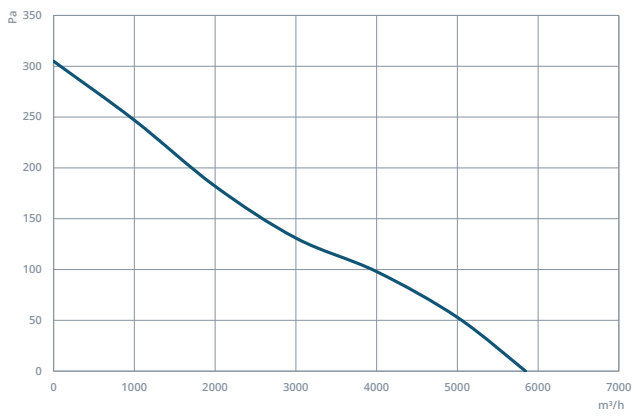

AXI 560-5-25

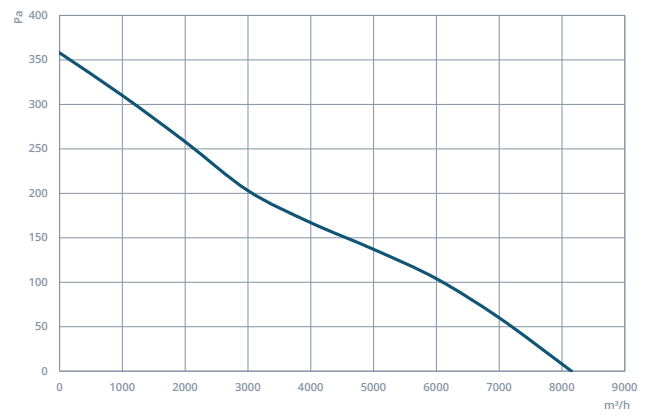

AXI 630-5-30

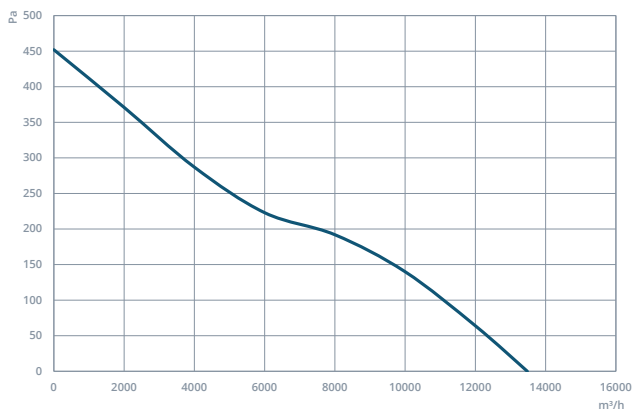

AXI 710-5-30

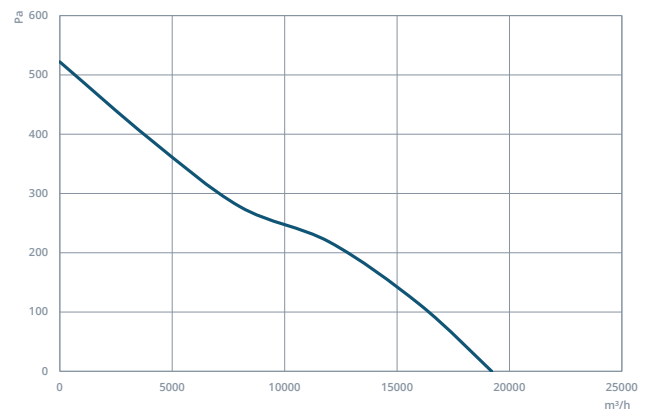

AXI 800-5-30

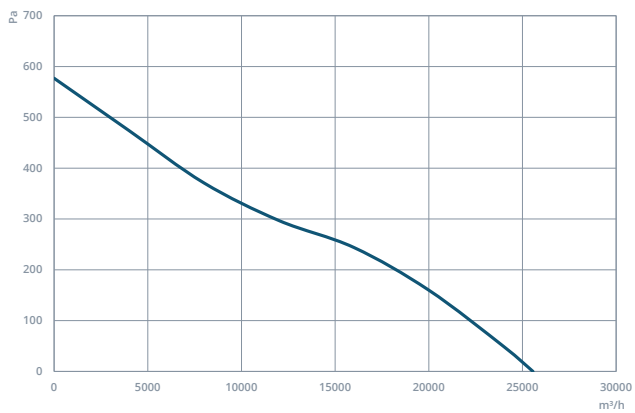

AXI 800-5-35

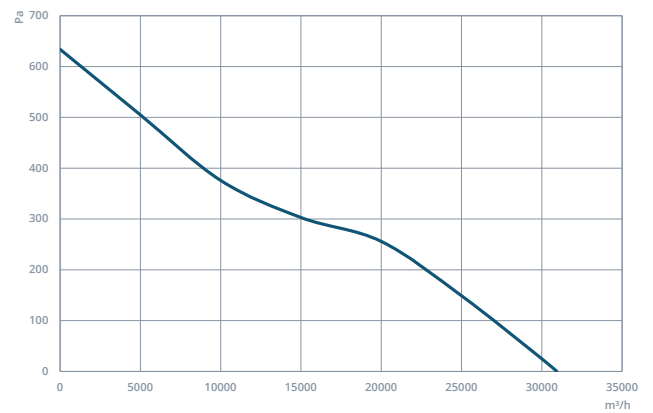

PERFORMANS EĞRİLERİ

AXI 900-5-35

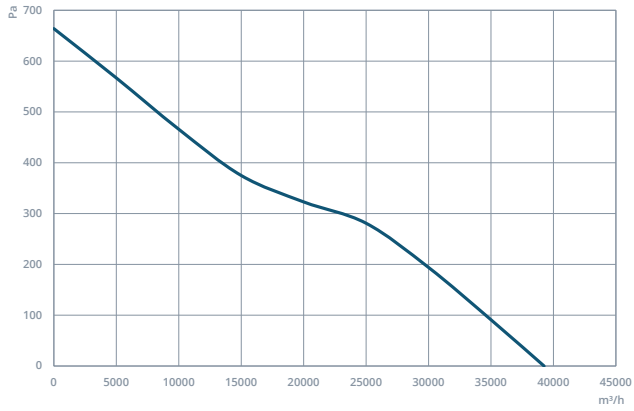

AXI 900-5-40

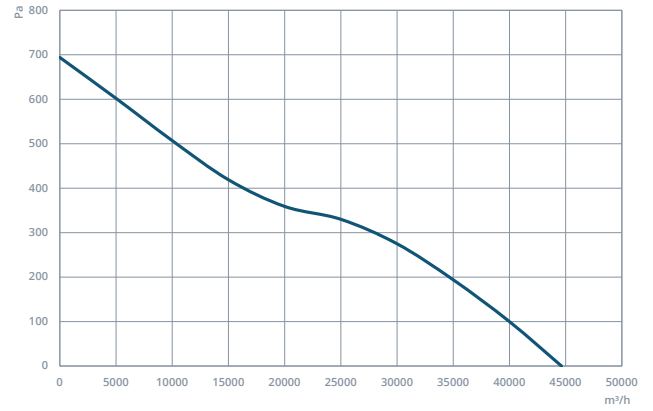

AXI 1000-5-40

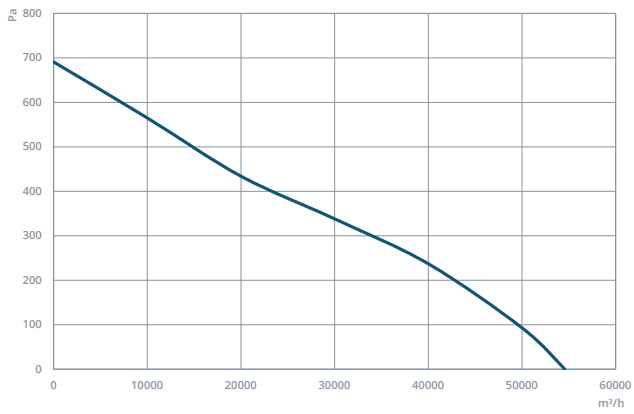

AXI 900-8-40

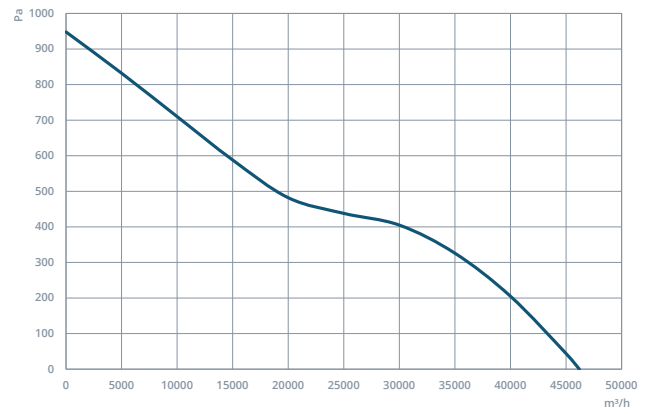

AXI 1000-8-40

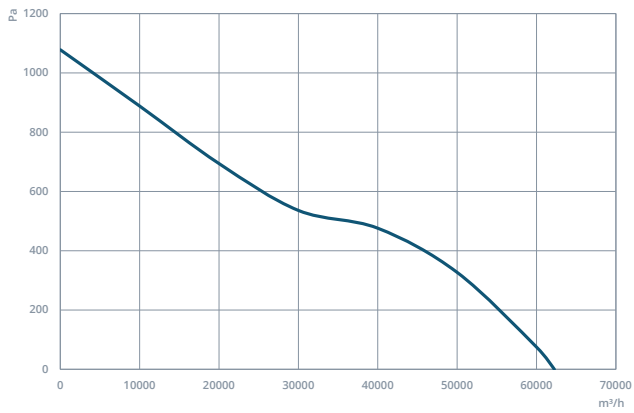

AXI 1000-8-45

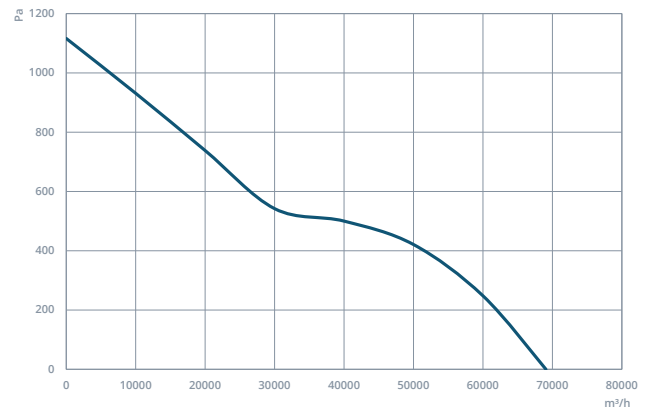

AXI 1120-8-40

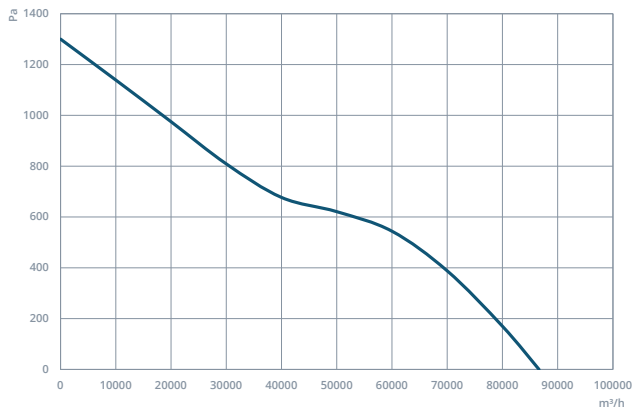

AXI 1120-8-45

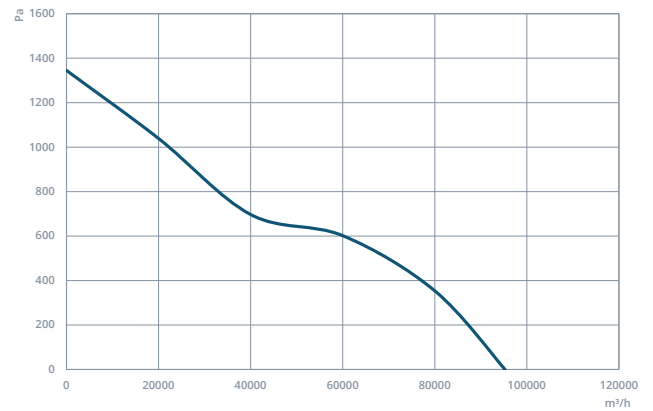

► AXI - 2P Yüksek Devirli Aksiyel Basınçlandırma Fanı

Aksiyel basınçlandırma fanları merdiven, asansör boşluğu vb. gibi basınçlandırma ihtiyaçlarını karşılamak için kullanılabilir. Kanallı sistemlerle yüksek debi ihtiyacı olan projelerde kullanılabilir.



MOTOR YALITIM SINIFI	F SINIFI
MOTOR KORUMA SINIFI	IP 55
MOTOR VERİM SINIFI	IE3
MOTOR TİPİ	TEFC
MOTOR MARKASI	-
GÖVDE MALZEMESİ	GALVANİZE SAC
GÖVDE KAPLAMASI	YOK
PERVANE MALZEMESİ	ALÜMİNYUM
GÖREV DÖNGÜSÜ	IEC Duty Cycle-S1
ÇALIŞMA SICAKLIĞI	-20 - +50 °C
STANDARTLAR	IEC-60335-2-80, ISO 1940-1



MODEL	VOLTAJ (V)	FREKANS (Hz)	GÜÇ (kW)	DEVİR (d/dk)	DEBİ (m³/h)	SES SEVİYESİ (dB(A))	FİYAT (€/Adet)
AXI 315-6-45	380	50	0,75	2.880	4.670	63	400,00 €
AXI 355-6-45	380	50	1,10	2.880	6.770	65	430,00 €
AXI 400-6-45	380	50	2,20	2.880	9.701	67	590,00 €
AXI 450-6-45	380	50	3,00	2.880	13.500	69	700,00 €
AXI 500-6-45	380	50	4,00	2.880	17.900	72	850,00 €
AXI 560-6-45	380	50	5,50	2.880	24.000	75	1.160,00 €
AXI 630-8-45	380	50	11,00	2.880	32.800	80	1.920,00 €

Değerler 0 Pa içindir

OPSİYONLAR



KORUMA TELİ		MONTAJ AYAĞI		KARŞI FLANŞ		KONNEKTÖR		TAKOZ		YAY		PANO	
ÖLÇÜ	FIYAT	ÖLÇÜ	FIYAT	ÖLÇÜ	FIYAT	ÖLÇÜ	FIYAT	ÖLÇÜ	FIYAT	ÖLÇÜ	FIYAT	ÖLÇÜ	FIYAT
315	30,00 €	315	27,00 €	315	48,00 €	315	107,00 €	315	48,00 €	315	142,00 €		
355	30,00 €	355	30,00 €	355	52,00 €	355	118,00 €	355	48,00 €	355	142,00 €		
400	37,00 €	400	33,00 €	400	58,00 €	400	130,00 €	400	48,00 €	400	142,00 €		
450	39,00 €	450	37,00 €	450	63,00 €	450	142,00 €	450	48,00 €	450	142,00 €		
500	45,00 €	500	43,00 €	500	69,00 €	500	157,00 €	500	48,00 €	500	142,00 €		
560	60,00 €	560	54,00 €	560	78,75 €	560	179,00 €	560	64,00 €	560	192,00 €	5,5 kW	570,00 €
630	75,00 €	630	69,00 €	630	93,00 €	630	207,00 €	630	64,00 €	630	192,00 €	7,5 kW	570,00 €

DIĞER OPSİYONLAR



İstenilen Renkte Elektro-Statik Toz Boya



Alüminyum veya Plastik Kanat Seçeneği

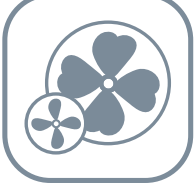

İstenilen Debi ve Basınca Özel Üretim



Sistem Otomasyonu



5, 8, 12 ve 16 Kanat Adedi Seçenekleri

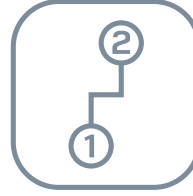

Çift Devirli Motor Seçeneği

TEKNİK RESİM

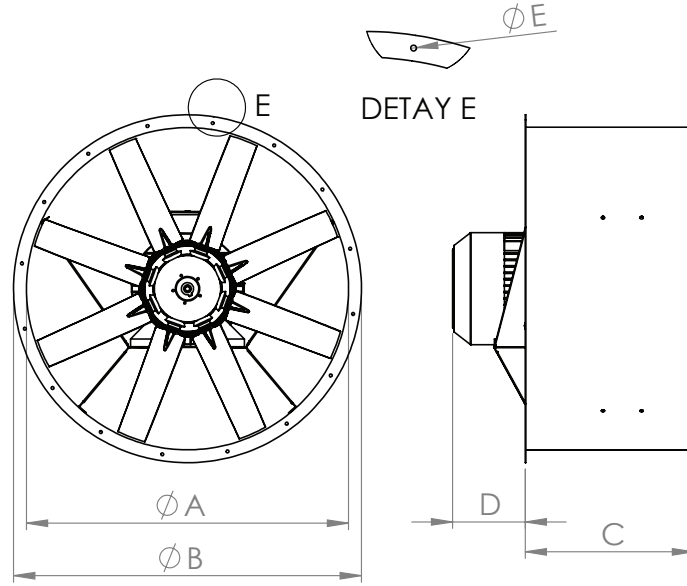

MODEL	A (mm)	B (mm)	C (mm)	D (mm)	E (mm)	N (Delik Sayısı)
AXI 315-6-45	315	395	320	80	11	8
AXI 355-6-45	355	435	320	80	11	8
AXI 400-6-45	400	480	420	45	11	8
AXI 450-6-45	450	530	420	50	11	12
AXI 500-6-45	500	580	420	95	11	12
AXI 560-6-45	560	640	520	20	11	12
AXI 630-8-45	630	710	520	175	11	12

PERFORMANS EĞRİLERİ

AXI 315-6-45

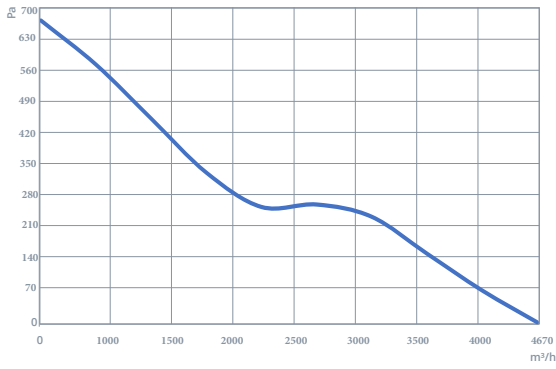

AXI 355-6-45

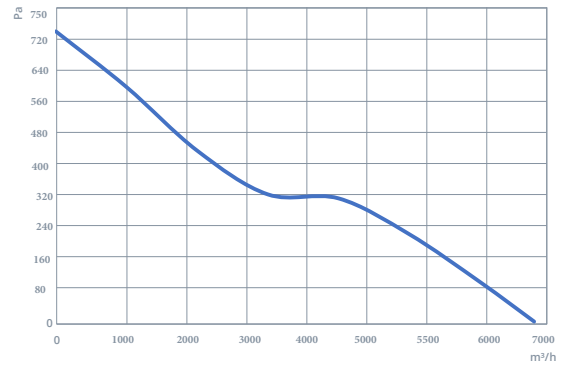

AXI 400-6-45

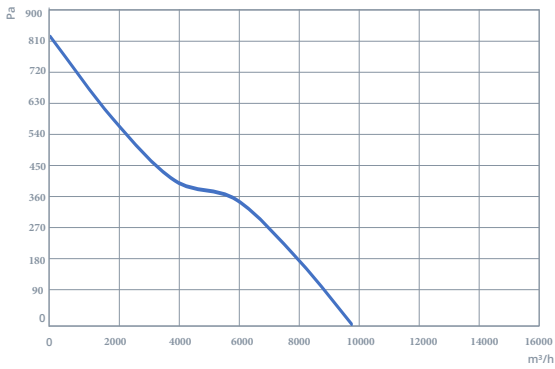

AXI 450-6-45

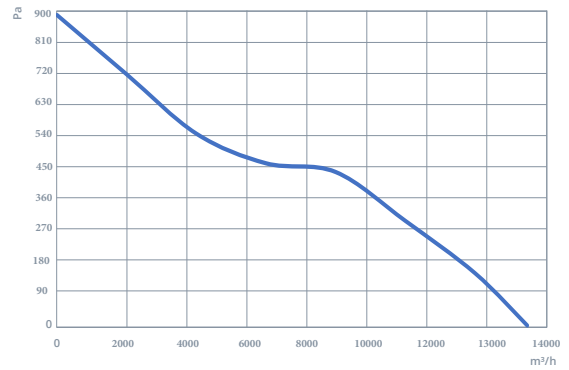

AXI 500-6-45

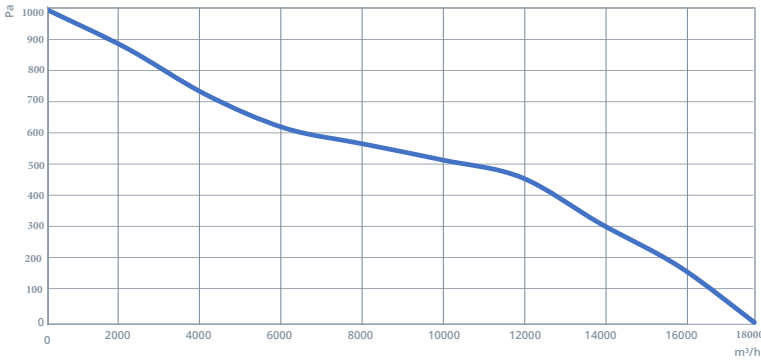

AXI 560-6-45

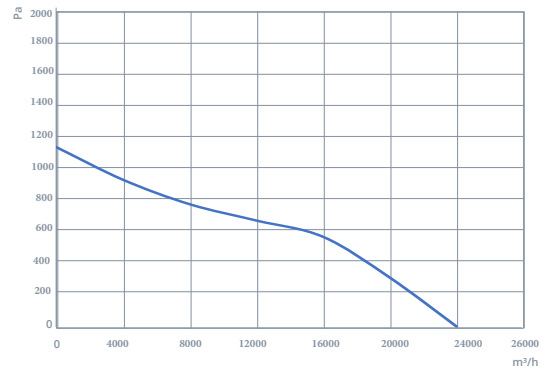

AXI 630-8-45

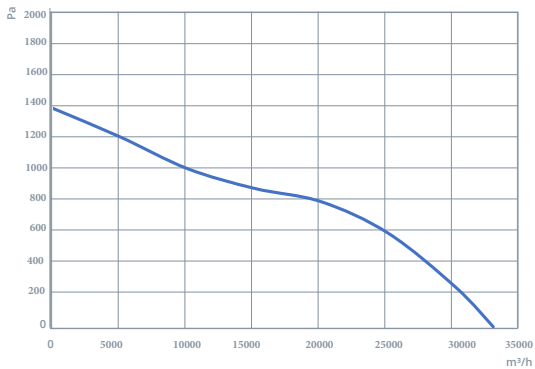

► TAXI - Aksiyel Duman Egzoz Fanı - F300

Aksiyel Duman Egzoz fanları 300 °C sıcaklığa iki saat boyunca dayanarak, Jet Fan'lar ile beraber otoparklarda yangın durumunda dumanın tahliyesini sağlamak için kullanılabilir.



MOTOR YALITIM SINIFI	H SINIFI
MOTOR KORUMA SINIFI	IP 54-IP 55
MOTOR VERİM SINIFI	IE1-IE2
MOTOR TİPİ	TEAO
MOTOR MARKASI	-
GÖVDE MALZEMESİ	GALVANİZE SAC
GÖVDE KAPLAMASI	YOK
PERVANE MALZEMESİ	ALÜMİNYUM
GÖREV DÖNGÜSÜ	IEC Duty Cycle-S1
ÇALIŞMA SICAKLIĞI	-20 - +50 °C
STANDARTLAR	IEC-60335-2-80, ISO 1940-1



MODEL	VOLTAJ (V)	FREKANS (Hz)	GÜÇ (kW)	DEVİR (d/dk)	DEBİ (m³/h)	SES SEVİYESİ (dB(A))	FİYAT (€/Adet)
TAXI 450-5-25	380	50	0,55	1.456	4.180	69	677,00 €
TAXI 500-5-25	380	50	0,55	1.453	5.845	72	690,00 €
TAXI 560-5-25	380	50	0,75	1.466	8.150	75	801,00 €
TAXI 630-5-30	380	50	1,10	1.465	13.480	80	900,00 €
TAXI 710-5-30	380	50	1,50	1.472	19.210	83	1.084,00 €
TAXI 800-5-30	380	50	2,20	1.459	25.560	85	1.281,00 €
TAXI 800-5-35	380	50	3,00	1.463	30.940	89	1.346,00 €
TAXI 900-5-35	380	50	4,00	1.471	39.250	90	1.432,00 €
TAXI 900-5-40	380	50	5,50	1.472	44.635	93	1.963,00 €
TAXI 1000-5-40	380	50	7,50	1.478	54.570	94	2.241,00 €
TAXI 900-8-40	380	50	11,00	1.454	46.200	94	3.309,00 €
TAXI 1000-8-40	380	50	15,00	1.456	62.250	97	3.733,00 €
TAXI 1000-8-45	380	50	18,50	1.458	69.070	99	4.225,00 €
TAXI 1120-8-40	380	50	22,00	1.471	86.620	100	4.607,00 €
TAXI 1120-8-45	380	50	30,00	1.474	95.270	102	5.688,00 €

Değerler 0 Pa içindir

OPSİYONLAR



KORUMA TELİ		MONTAJ AYAĞI		KARŞI FLANŞ		KONNEKTÖR		YAY	
ÖLÇÜ	FIYAT	ÖLÇÜ	FIYAT	ÖLÇÜ	FIYAT	ÖLÇÜ	FIYAT	ÖLÇÜ	FIYAT
450	30,00 €	450	30,00 €	450	52,00 €	450	212,00 €	450	142,00 €
500	37,00 €	500	33,00 €	500	58,00 €	500	239,00 €	500	142,00 €
560	39,00 €	560	37,00 €	560	63,00 €	560	258,00 €	560	142,00 €
630	45,00 €	630	43,00 €	630	69,00 €	630	284,00 €	630	142,00 €
710	60,00 €	710	54,00 €	710	79,00 €	710	327,00 €	710	192,00 €
800	75,00 €	800	69,00 €	800	93,00 €	800	379,00 €	800	192,00 €
900	94,00 €	900	85,00 €	900	99,00 €	900	407,00 €	900	192,00 €
1000	142,00 €	1000	127,00 €	1000	107,00 €	1000	452,00 €	1000	192,00 €
1120	163,00 €	1120	148,00 €	1120	124,00 €	1120	513,00 €	1120	192,00 €

DIĞER OPSİYONLAR



İstenilen Debi ve Basınca Özel Üretim

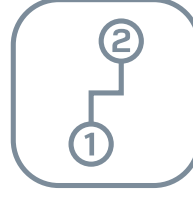

Çift Devirli Motor Seçeneđi



5, 8, 12 ve 16 Kanat Adedi Seçenekleri



Sistem Otomasyonu

TEKNİK RESİM

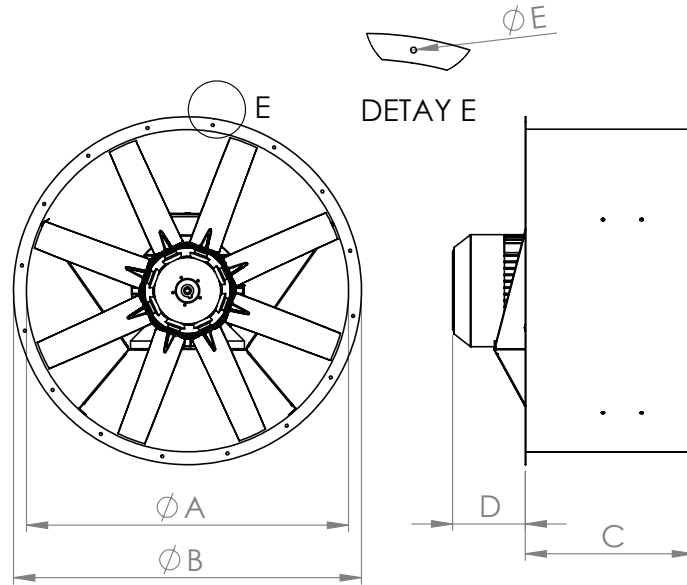

MODEL	A (mm)	B (mm)	C (mm)	D (mm)	E (mm)	N (Delik Sayısı)
TAXI 450-5-25	450	530	320	50	11	8
TAXI 500-5-25	500	580	320	70	11	8
TAXI 560-5-25	560	640	320	60	11	12
TAXI 630-5-30	630	710	420	45	11	12
TAXI 710-5-30	710	790	420	25	11	12
TAXI 800-5-30	800	880	420	50	11	16
TAXI 800-5-35	800	880	420	50	11	16
TAXI 900-5-35	900	980	520	0	11	16
TAXI 900-5-40	900	980	520	35	11	16
TAXI 1000-5-40	1000	1080	520	150	11	16
TAXI 900-8-40	900	980	520	75	11	16
TAXI 1000-8-40	1000	1080	520	180	11	16
TAXI 1000-8-45	1000	1080	520	250	11	16
TAXI 1120-8-40	1120	1200	800	250	11	16
TAXI 1120-8-45	1120	1200	800	300	11	16

PERFORMANS EĞRİLERİ

TAXI 450-5-25

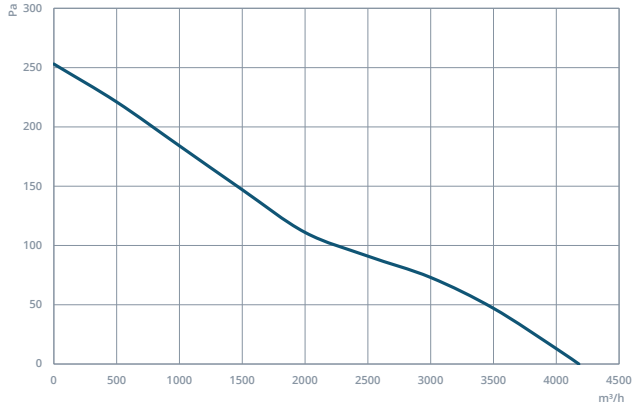

TAXI 500-5-25

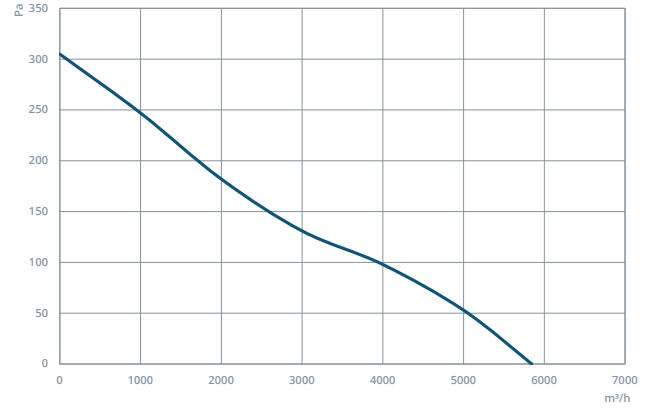

TAXI 560-5-25

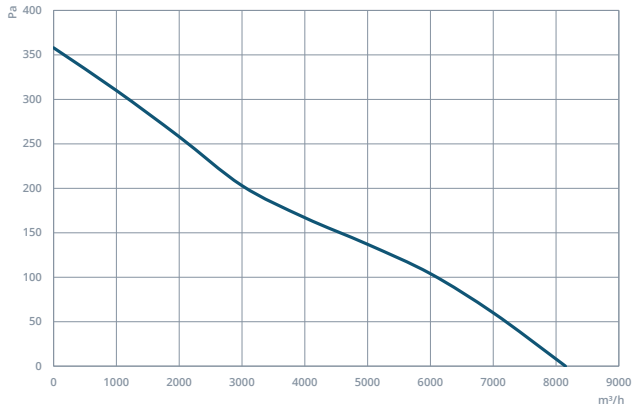

TAXI 630-5-30

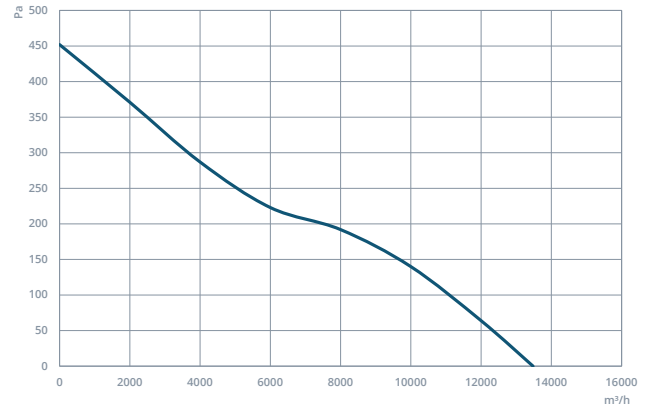

TAXI 710-5-30

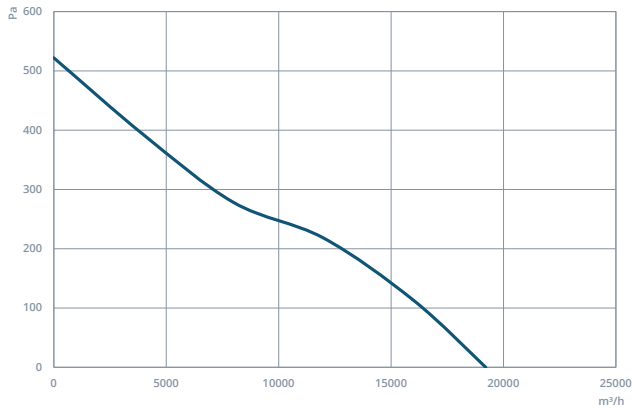

TAXI 800-5-30

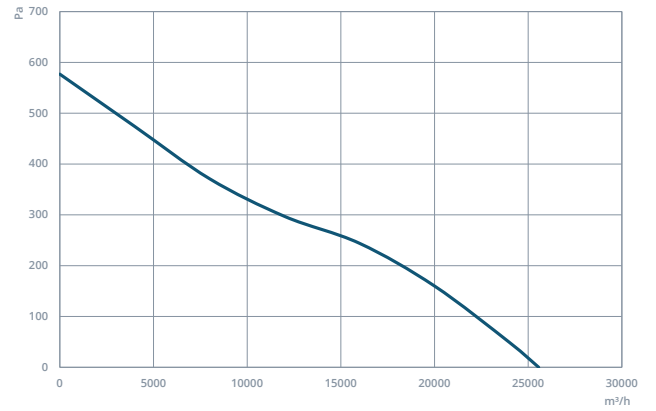

TAXI 800-5-35

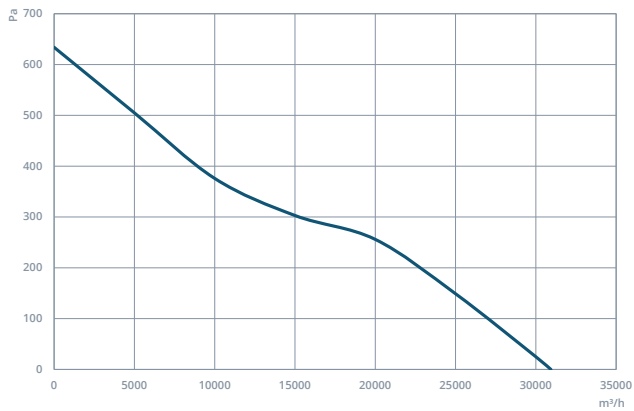

TAXI 900-5-35

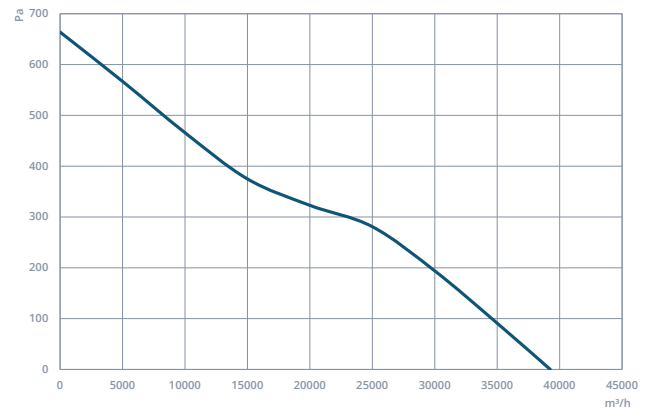

PERFORMANS EĞRİLERİ

TAXI 900-5-40

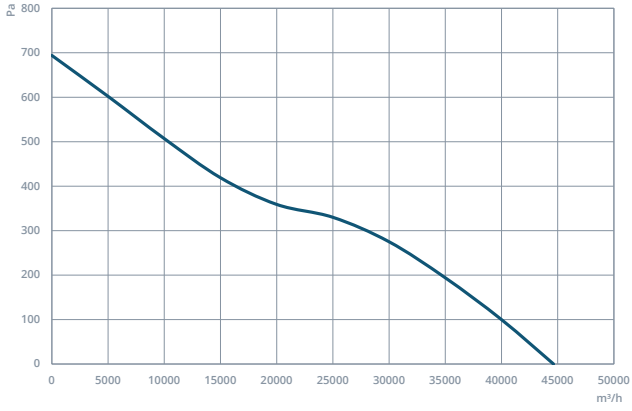

TAXI 1000-5-40

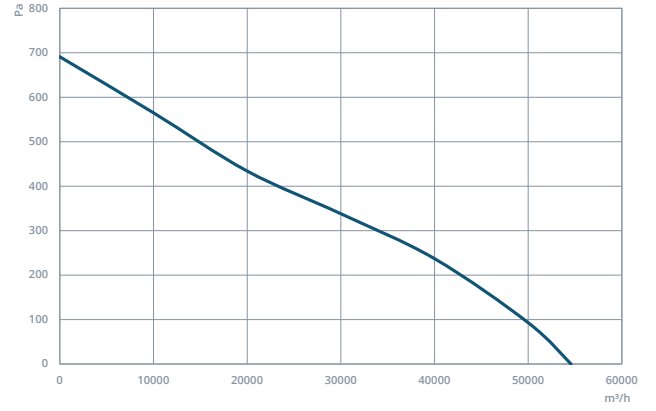

TAXI 900-8-40

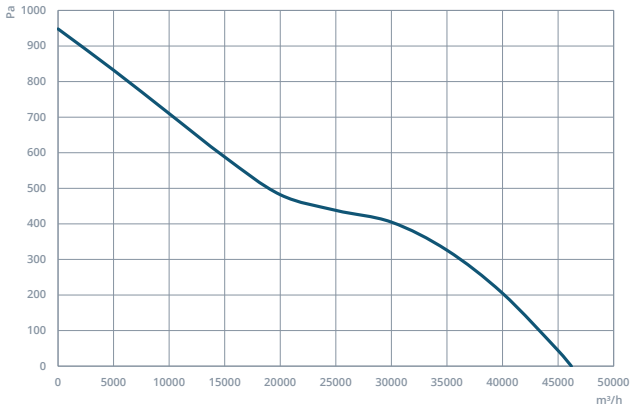

TAXI 1000-8-40

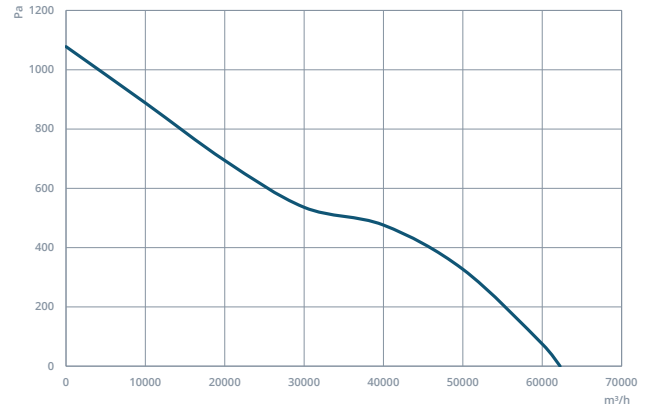

TAXI 1000-8-45

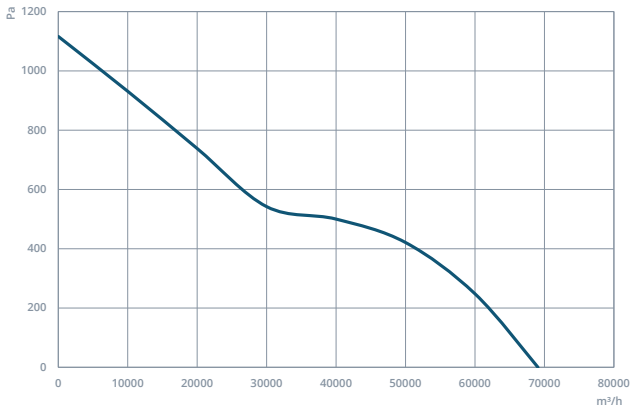

TAXI 1120-8-40

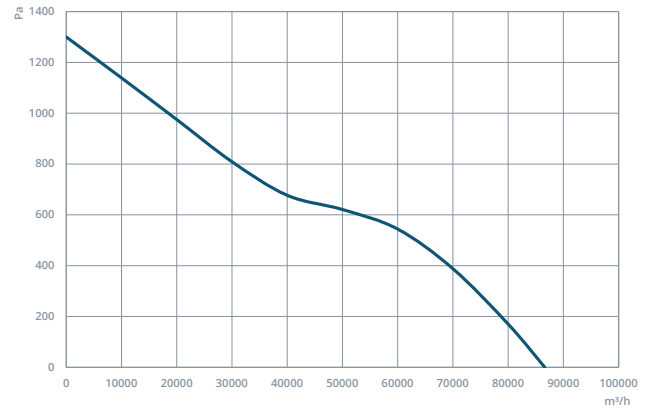

TAXI 1120-8-45

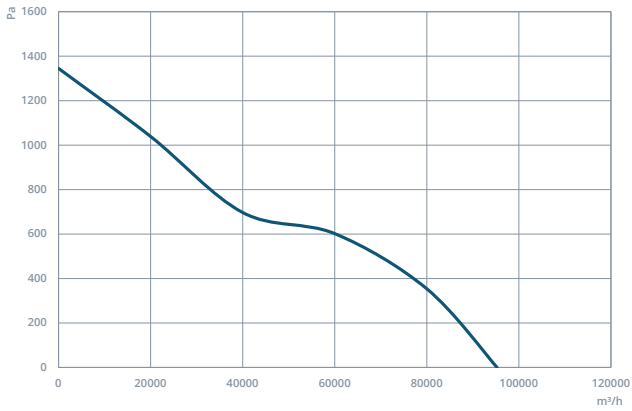

► TAXI - 2P Yüksek Devirli Aksiyel Duman Egzoz Fanı - F300

Aksiyel Duman Egzoz fanları 300 °C sıcaklığa iki saat boyunca dayanarak, Jet Fan'lar ile beraber otoparklarda yangın durumunda dumanın tahliyesini sağlamak için kullanılabilir.



MOTOR YALITIM SINIFI	H SINIFI
MOTOR KORUMA SINIFI	IP 54-IP 55
MOTOR VERİM SINIFI	IE1-IE2
MOTOR TİPİ	TEAO
MOTOR MARKASI	-
GÖVDE MALZEMESİ	GALVANİZE SAC
GÖVDE KAPLAMASI	YOK
PERVANE MALZEMESİ	ALÜMİNYUM
GÖREV DÖNGÜSÜ	IEC Duty Cycle-S1
ÇALIŞMA SICAKLIĞI	-20 - +50 °C
STANDARTLAR	IEC-60335-2-80, ISO 1940-1



MODEL	VOLTAJ (V)	FREKANS (Hz)	GÜÇ (kW)	DEVİR (d/dk)	DEBİ (m³/h)	SES SEVİYESİ (dB(A))	FİYAT (€/Adet)
TAXI 315-6-45	380	50	0,75	2.880	4.670	63	624,00 €
TAXI 355-6-45	380	50	1,10	2.880	6.770	65	670,00 €
TAXI 400-6-45	380	50	2,20	2.880	9.701	67	842,00 €
TAXI 450-6-45	380	50	3,00	2.880	13.500	69	1.057,00 €
TAXI 500-6-45	380	50	4,00	2.880	17.900	72	1.212,00 €
TAXI 560-6-45	380	50	5,50	2.880	24.000	75	1.725,00 €
TAXI 630-8-45	380	50	11,00	2.880	32.800	80	2.710,00 €

Değerler 0 Pa içindir

OPSİYONLAR



KORUMA TELİ		MONTAJ AYAĞI		KARŞI FLANŞ		KONNEKTÖR		YAY	
ÖLÇÜ	FIYAT	ÖLÇÜ	FIYAT	ÖLÇÜ	FIYAT	ÖLÇÜ	FIYAT	ÖLÇÜ	FIYAT
315	30,00 €	315	27,00 €	315	48,00 €	315	107,00 €	315	142,00 €
355	30,00 €	355	30,00 €	355	52,00 €	355	118,00 €	355	142,00 €
400	37,00 €	400	33,00 €	400	58,00 €	400	130,00€	400	142,00 €
450	39,00 €	450	37,00 €	450	63,00 €	450	142,00 €	450	142,00 €
500	45,00 €	500	43,00 €	500	69,00 €	500	157,00 €	500	142,00 €
560	60,00 €	560	54,00 €	560	78,75 €	560	179,00 €	560	192,00 €
630	75,00 €	630	69,00 €	630	93,00 €	630	207,00 €	630	192,00 €

DIĞER OPSİYONLAR



İstenilen Renkte Elektro-Statik Toz Boya



Alüminyum veya Plastik Kanat Seçeneği

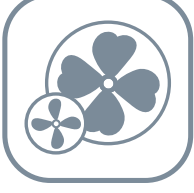

İstenilen Debi ve Basınca Özel Üretim



Sistem Otomasyonu



5, 8, 12 ve 16 Kanat Adedi Seçenekleri

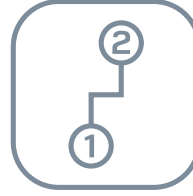

Çift Devirli Motor Seçeneği

TEKNİK RESİM

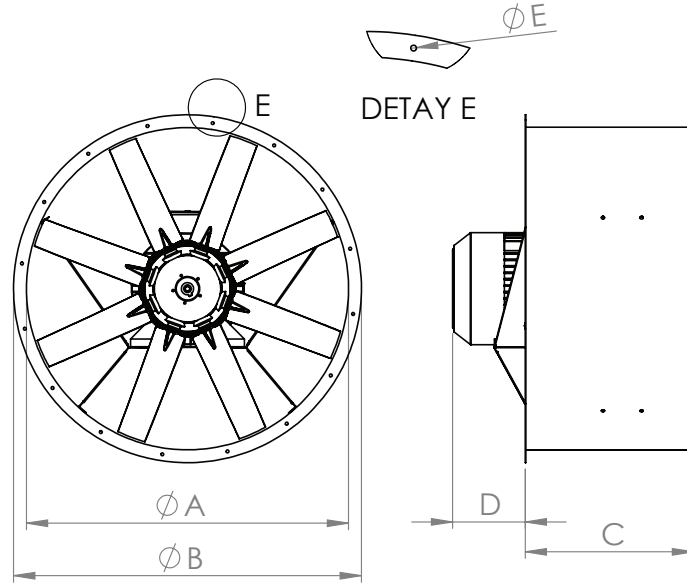

MODEL	A (mm)	B (mm)	C (mm)	D (mm)	E (mm)	N (Delik Sayısı)
TAXI 315-6-45	315	395	320	80	11	8
TAXI 355-6-45	355	435	320	80	11	8
TAXI 400-6-45	400	480	420	45	11	8
TAXI 450-6-45	450	530	420	50	11	12
TAXI 500-6-45	500	580	420	95	11	12
TAXI 560-6-45	560	640	520	20	11	12
TAXI 630-8-45	630	710	520	175	11	12

PERFORMANS EĞRİLERİ

TAXI 315-6-45

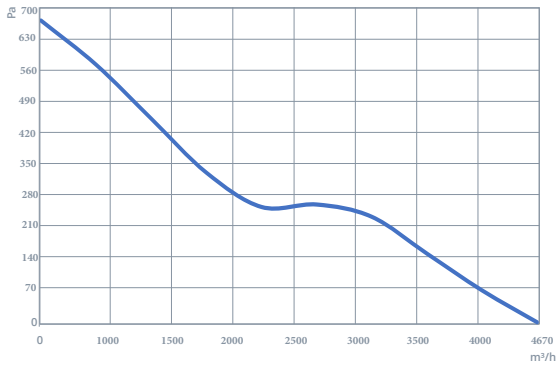

TAXI 355-6-45

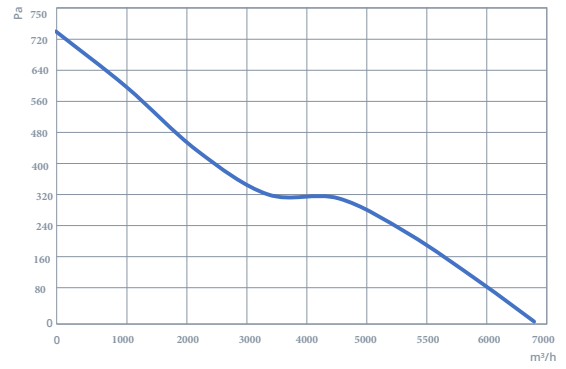

TAXI 400-6-45

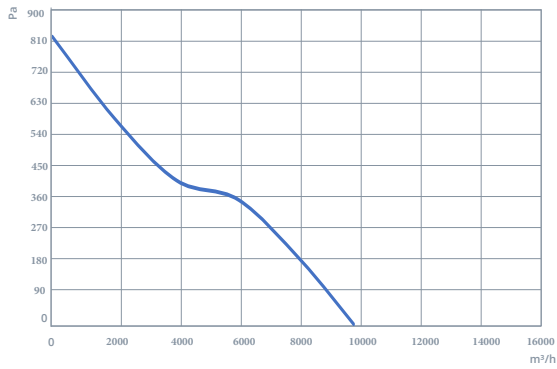

TAXI 450-6-45

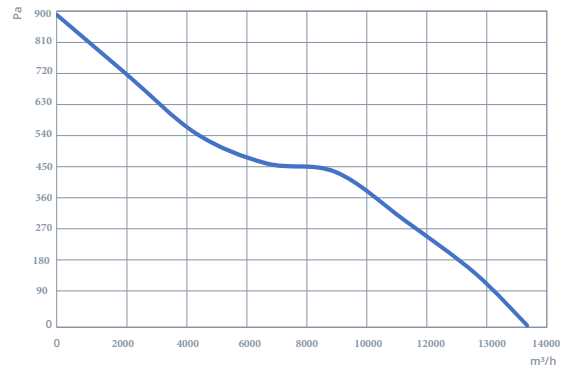

TAXI 500-6-45

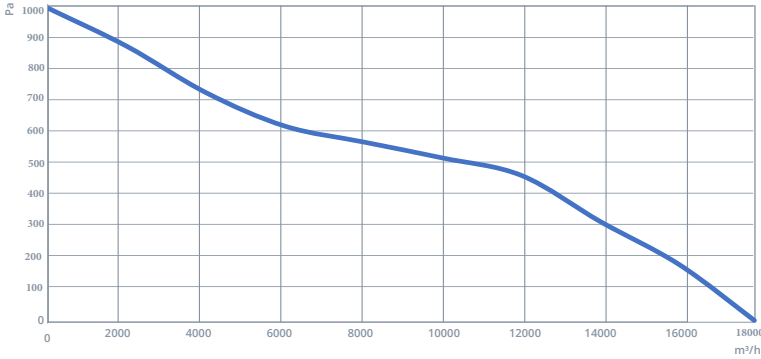

TAXI 560-6-45

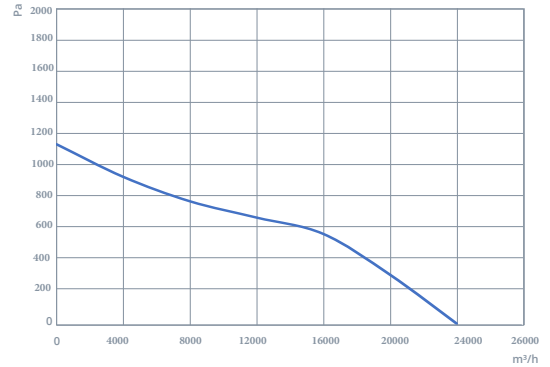

TAXI 630-8-45

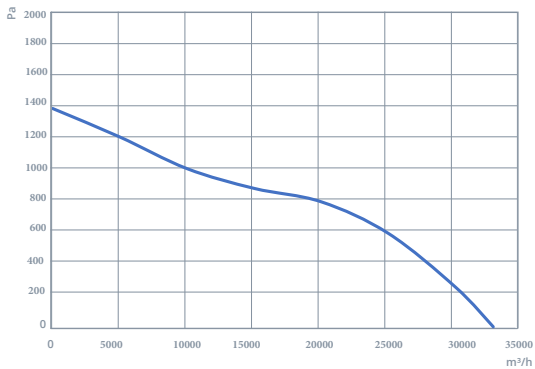

► TAXI - Aksiyel Duman Egzoz Fanı - F400

Aksiyel Duman Egzoz fanları 400 °C sıcaklığa iki saat boyunca dayanarak, Jet Fan'lar ile beraber otoparklarda yangın durumunda dumanın tahliyesini sağlamak için kullanılabilir.



MOTOR YALITIM SINIFI	H SINIFI
MOTOR KORUMA SINIFI	IP 54-IP 55
MOTOR VERİM SINIFI	IE1-IE2
MOTOR TİPİ	TEAO
MOTOR MARKASI	-
GÖVDE MALZEMESİ	GALVANİZE SAC
GÖVDE KAPLAMASI	YOK
PERVANE MALZEMESİ	ALÜMİNYUM
GÖREV DÖNGÜSÜ	IEC Duty Cycle-S1
ÇALIŞMA SICAKLIĞI	-20 - +50 °C
STANDARTLAR	IEC-60335-2-80, ISO 1940-1



MODEL	VOLTAJ (V)	FREKANS (Hz)	GÜÇ (kW)	DEVİR (d/dk)	DEBİ (m³/h)	SES SEVİYESİ (dB(A))	FİYAT (€/Adet)
TAXI 450-5-25	380	50	0,55	1.456	4.180	69	1.440,00 €
TAXI 500-5-25	380	50	0,55	1.453	5.845	72	1.495,00 €
TAXI 560-5-25	380	50	0,75	1.466	8.150	75	1.564,00 €
TAXI 630-5-30	380	50	1,10	1.465	13.480	80	1.834,00 €
TAXI 710-5-30	380	50	1,50	1.472	19.210	83	2.079,00 €
TAXI 800-5-30	380	50	2,20	1.459	25.560	85	2.391,00 €
TAXI 800-5-35	380	50	3,00	1.463	30.940	89	2.589,00 €
TAXI 900-5-35	380	50	4,00	1.471	39.250	90	3.025,00 €
TAXI 900-5-40	380	50	5,50	1.472	44.635	93	3.720,00 €
TAXI 1000-5-40	380	50	7,50	1.478	54.570	94	4.274,00 €
TAXI 900-8-40	380	50	11,00	1.454	46.200	94	5.906,00 €
TAXI 1000-8-40	380	50	15,00	1.456	62.250	97	6.904,00 €
TAXI 1000-8-45	380	50	18,50	1.458	69.070	99	7.527,00 €
TAXI 1120-8-40	380	50	22,00	1.471	86.620	100	8.374,00 €
TAXI 1120-8-45	380	50	30,00	1.474	95.270	102	10.517,00 €

Değerler 0 Pa içindir

OPSİYONLAR



KORUMA TELİ		MONTAJ AYAĞI		KARŞI FLANŞ		KONNEKTÖR		YAY	
ÖLÇÜ	FİYAT	ÖLÇÜ	FİYAT	ÖLÇÜ	FİYAT	ÖLÇÜ	FİYAT	ÖLÇÜ	FİYAT
450	30,00 €	450	30,00 €	450	52,00 €	450	354,00 €	450	142,00 €
500	37,00 €	500	33,00 €	500	58,00 €	500	400,00 €	500	142,00 €
560	39,00 €	560	37,00 €	560	63,00 €	560	433,00 €	560	142,00 €
630	45,00 €	630	43,00 €	630	69,00 €	630	475,00 €	630	142,00 €
710	60,00 €	710	54,00 €	710	79,00 €	710	545,00 €	710	192,00 €
800	75,00 €	800	69,00 €	800	93,00 €	800	637,00 €	800	192,00 €
900	94,00 €	900	85,00 €	900	99,00 €	900	680,00 €	900	192,00 €
1000	142,00 €	1000	127,00 €	1000	107,00 €	1000	758,00 €	1000	192,00 €
1120	163,00 €	1120	148,00 €	1120	124,00 €	1120	859,00 €	1120	192,00 €

DIĞER OPSİYONLAR



İstenilen Debi ve Basınca Özel Üretim

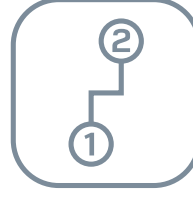

Çift Devirli Motor Seçeneği



5, 8, 12 ve 16 Kanat Adedi Seçenekleri



Sistem Otomasyonu

TEKNİK RESİM

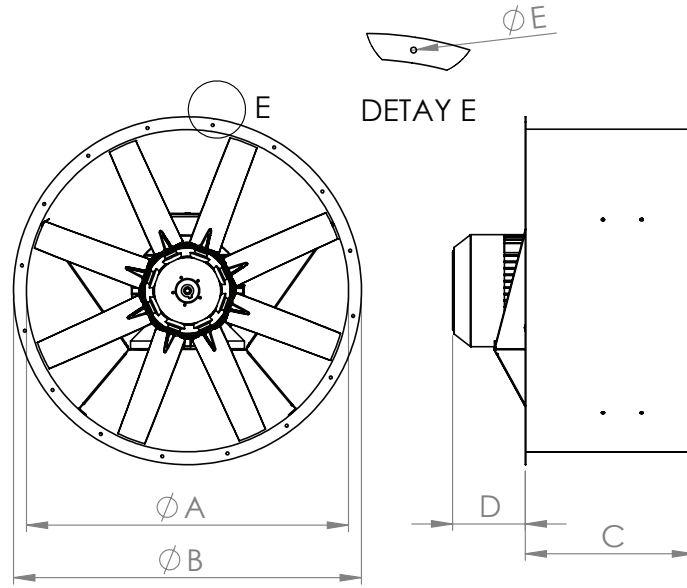

MODEL	A (mm)	B (mm)	C (mm)	D (mm)	E (mm)	N (Delik Sayısı)
TAXI 450-5-25	450	530	320	50	11	8
TAXI 500-5-25	500	580	320	70	11	8
TAXI 560-5-25	560	640	320	60	11	12
TAXI 630-5-30	630	710	420	45	11	12
TAXI 710-5-30	710	790	420	25	11	12
TAXI 800-5-30	800	880	420	50	11	16
TAXI 800-5-35	800	880	420	50	11	16
TAXI 900-5-35	900	980	520	0	11	16
TAXI 900-5-40	900	980	520	35	11	16
TAXI 1000-5-40	1000	1080	520	150	11	16
TAXI 900-8-40	900	980	520	75	11	16
TAXI 1000-8-40	1000	1080	520	180	11	16
TAXI 1000-8-45	1000	1080	520	250	11	16
TAXI 1120-8-40	1120	1200	800	250	11	16
TAXI 1120-8-45	1120	1200	800	300	11	16

PERFORMANS EĞRİLERİ

TAXI 450-5-25

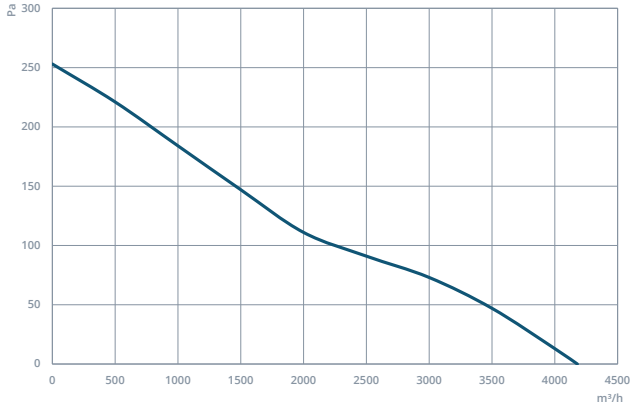

TAXI 500-5-25

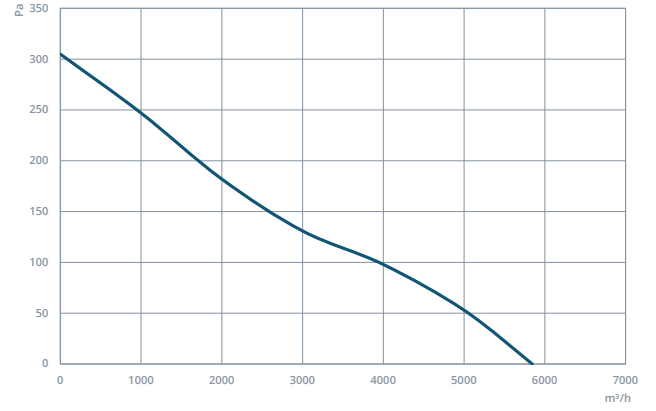

TAXI 560-5-25

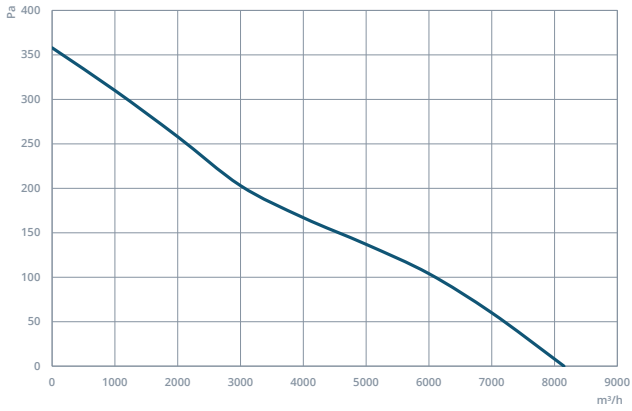

TAXI 630-5-30

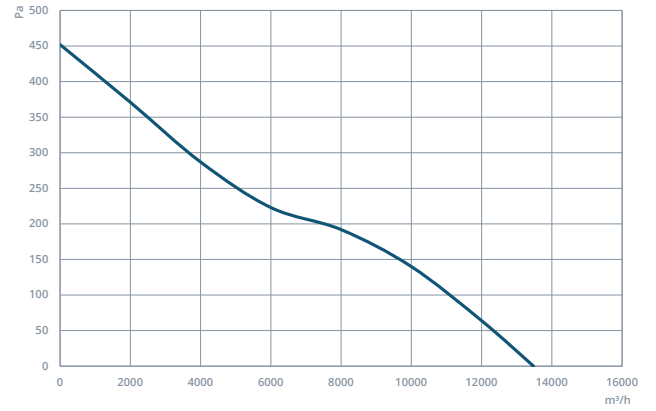

TAXI 710-5-30

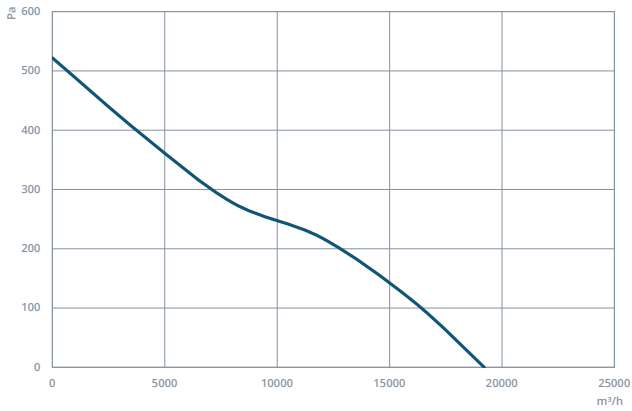

TAXI 800-5-30

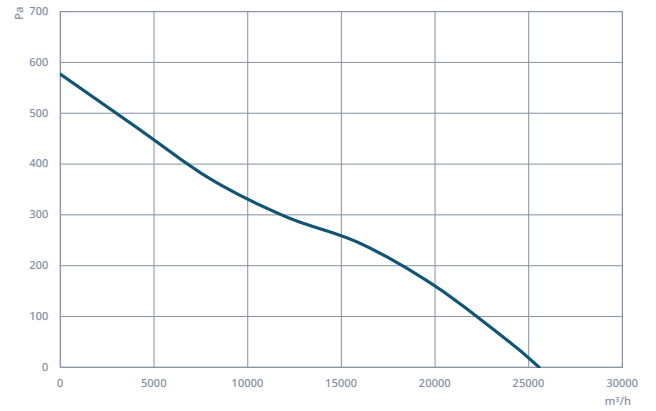

TAXI 800-5-35

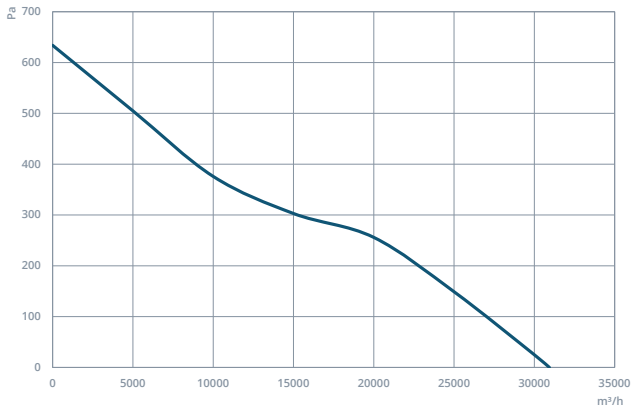

TAXI 900-5-35

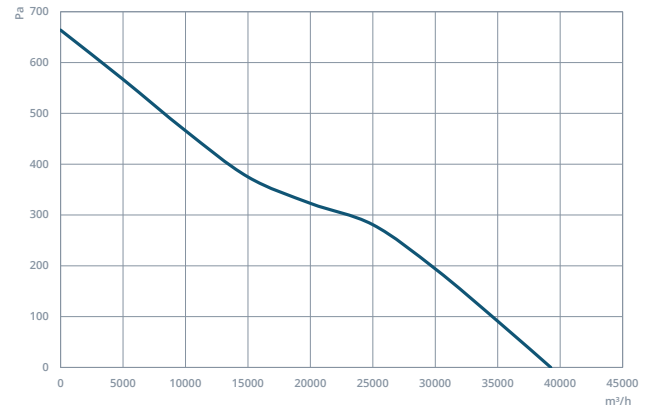

PERFORMANS EĞRİLERİ

TAXI 900-5-40

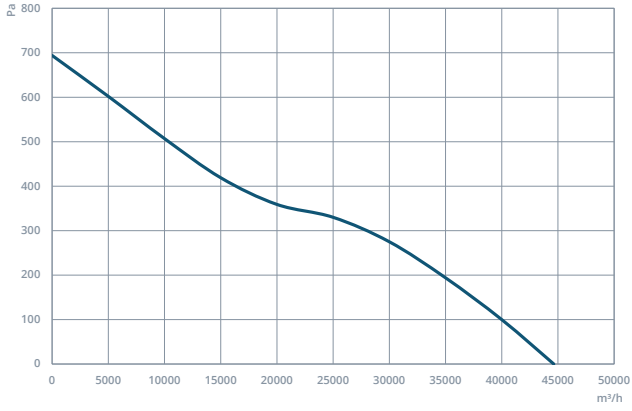

TAXI 1000-5-40

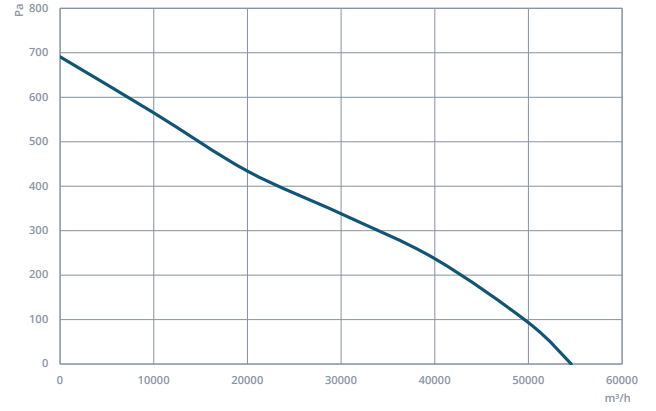

TAXI 900-8-40

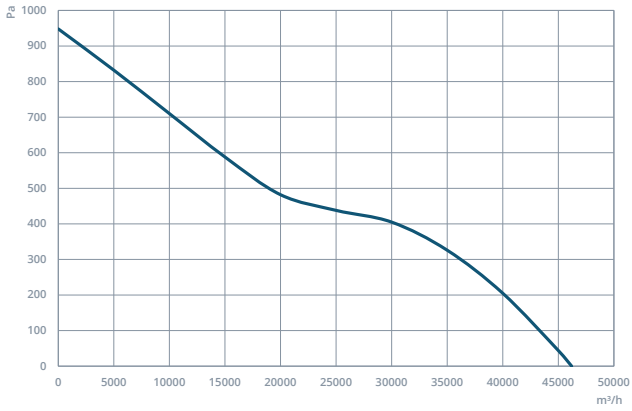

TAXI 1000-8-40

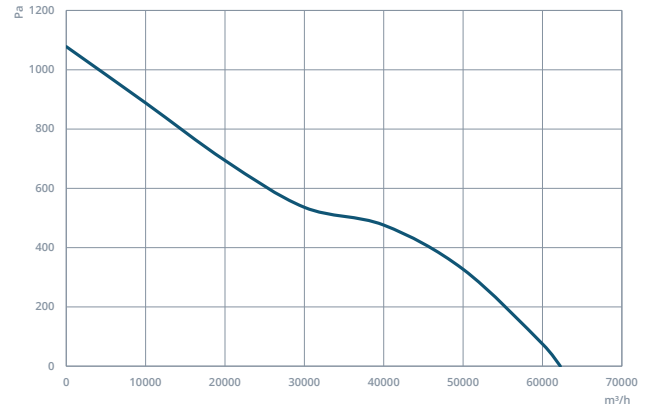

TAXI 1000-8-45

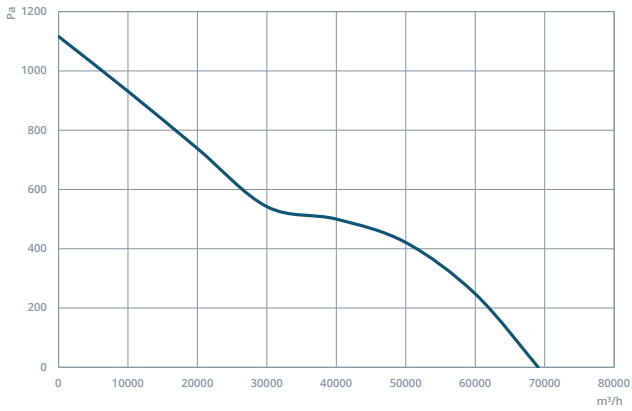

TAXI 1120-8-40

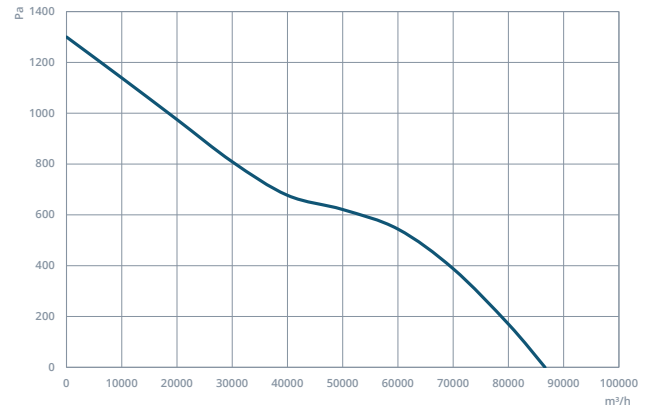

TAXI 1120-8-45

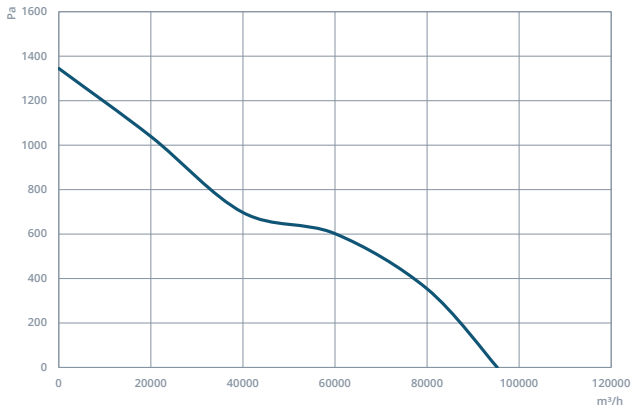

► PAXI - Exproof Motorlu Aksiyel Fan

Exproof motorlu aksiyel fanlar kıvılcım çıkarmayan motoru ve pervane çevresindeki alüminyum bandı ile ATEX ihtiyacı olan yerlerde kullanılabilir. ATEX sınıfı Zone 1 ve Zone 2 Grup: IIA, IIB ve IIC olarak kullanılabilir.
ATEX SINIF SEÇİMİ MÜŞTERİ SORUMLULUĞUNDADIR.



MOTOR YALITIM SINIFI	F SINIFI
MOTOR KORUMA SINIFI	IP 55
MOTOR VERİM SINIFI	IE2
MOTOR TİPİ	TEFC
MOTOR MARKASI	-
GÖVDE MALZEMESİ	GALVANİZE SAC
GÖVDE KAPLAMASI	YOK
PERVANE MALZEMESİ	ALÜMİNYUM
GÖREV DÖNGÜSÜ	IEC Duty Cycle-S1
ÇALIŞMA SICAKLIĞI	-20 - +50 °C
STANDARTLAR	IEC-60335-2-80, ISO 1940-1



MODEL	VOLTAJ (V)	FREKANS (Hz)	GÜÇ (kW)	DEVİR (d/dk)	DEBİ (m³/h)	SES SEVİYESİ (dB(A))	FİYAT (€/Adet)
PAXI 450-5-25	380	50	0,55	1456	4.180	69	1.700,00 €
PAXI 500-5-25	380	50	0,55	1453	5.845	72	1.800,00 €
PAXI 560-5-25	380	50	0,75	1466	8.150	75	1.900,00 €
PAXI 630-5-30	380	50	1,10	1465	13.480	80	2.000,00 €
PAXI 710-5-30	380	50	1,50	1472	19.210	83	2.200,00 €
PAXI 800-5-30	380	50	2,20	1459	25.560	85	2.805,00 €
PAXI 800-5-35	380	50	3,00	1463	30.940	89	3.200,00 €
PAXI 900-5-35	380	50	4,00	1471	39.250	90	3.600,00 €
PAXI 900-5-40	380	50	5,50	1472	44.635	93	4.207,00 €
PAXI 1000-5-40	380	50	7,50	1478	54.570	94	5.330,00 €

Değerler 0 Pa içindir

OPSİYONLAR



KORUMA TELİ		MONTAJ AYAĞI		KARŞI FLANŞ		KONNEKTÖR		TAKOZ		YAY	
ÖLÇÜ	FIYAT	ÖLÇÜ	FIYAT	ÖLÇÜ	FIYAT	ÖLÇÜ	FIYAT	ÖLÇÜ	FIYAT	ÖLÇÜ	FIYAT
450	30,00 €	450	30,00 €	450	52,00 €	450	118,00 €	450	48,00 €	450	142,00 €
500	37,00 €	500	33,00 €	500	58,00 €	500	130,00 €	500	48,00 €	500	142,00 €
560	39,00 €	560	37,00 €	560	63,00 €	560	142,00 €	560	48,00 €	560	142,00 €
630	45,00 €	630	43,00 €	630	69,00 €	630	157,00 €	630	48,00 €	630	142,00 €
710	60,00 €	710	54,00 €	710	79,00 €	710	179,00 €	710	64,00 €	710	192,00 €
800	75,00 €	800	69,00 €	800	93,00 €	800	207,00 €	800	64,00 €	800	192,00 €
900	94,00 €	900	85,00 €	900	99,00 €	900	222,00 €	900	64,00 €	900	192,00 €
1000	142,00 €	1000	127,00 €	1000	107,00 €	1000	248,00 €	1000	64,00 €	1000	192,00 €

DIĞER OPSİYONLAR



İstenilen Debi ve Basınca Özel Üretim

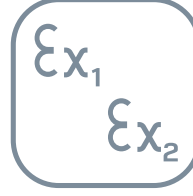

Farklı ATEX Sınıfları



5, 8, 12 ve 16 Kanat Adedi Seçenekleri



Sistem Otomasyonu

TEKNİK RESİM

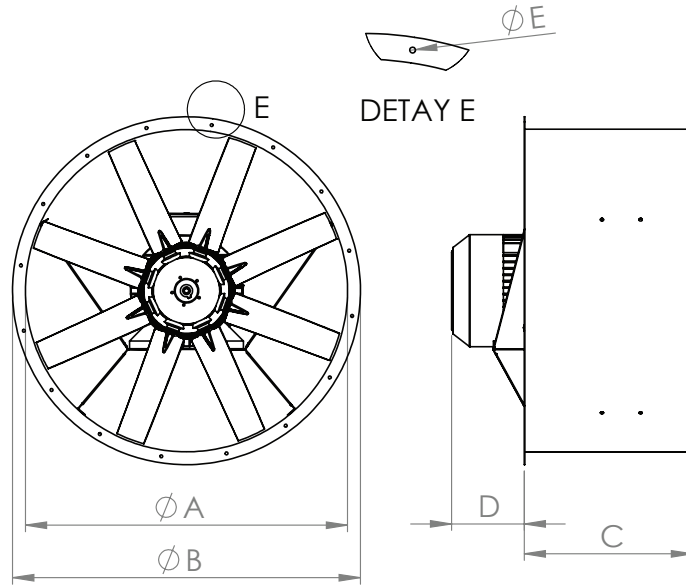

MODEL	A (mm)	B (mm)	C (mm)	D (mm)	E (mm)	N (Delik Sayısı)
PAXI 450-5-25	450	530	320	50	11	8
PAXI 500-5-25	500	580	320	70	11	8
PAXI 560-5-25	560	640	320	60	11	12
PAXI 630-5-30	630	710	420	45	11	12
PAXI 710-5-30	710	790	420	25	11	12
PAXI 800-5-30	800	880	420	50	11	16
PAXI 800-5-35	800	880	420	50	11	16
PAXI 900-5-35	900	980	520	0	11	16
PAXI 900-5-40	900	980	520	35	11	16
PAXI 1000-5-40	1000	1080	520	150	11	16
PAXI 900-8-40	900	980	520	75	11	16
PAXI 1000-8-40	1000	1080	520	180	11	16

PERFORMANS EĞRİLERİ

PAXI 450-5-25

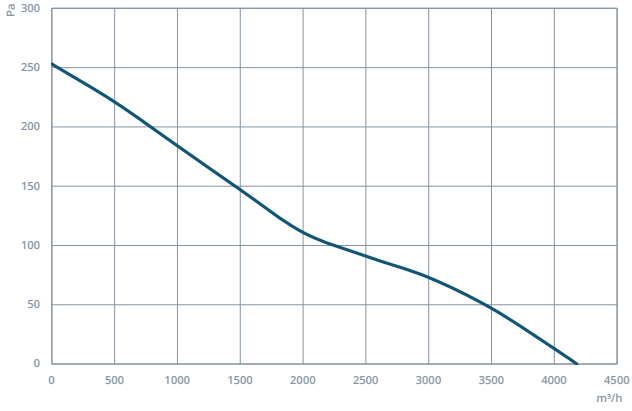

PAXI 500-5-25

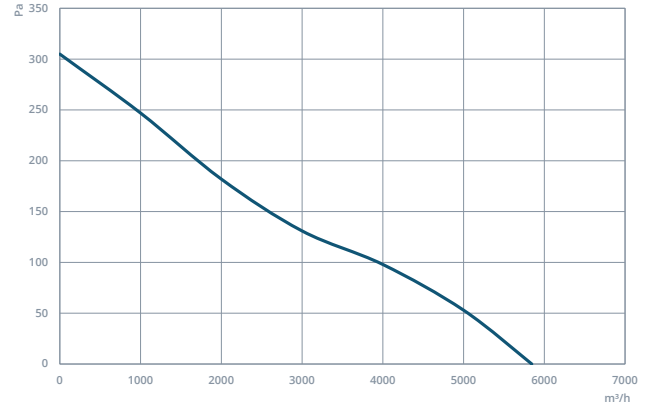

PAXI 560-5-25

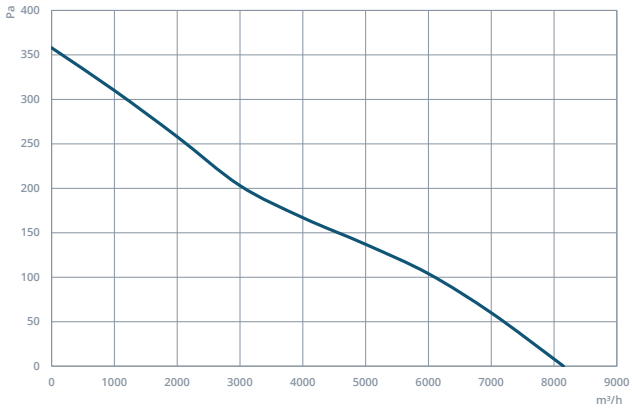

PAXI 630-5-30

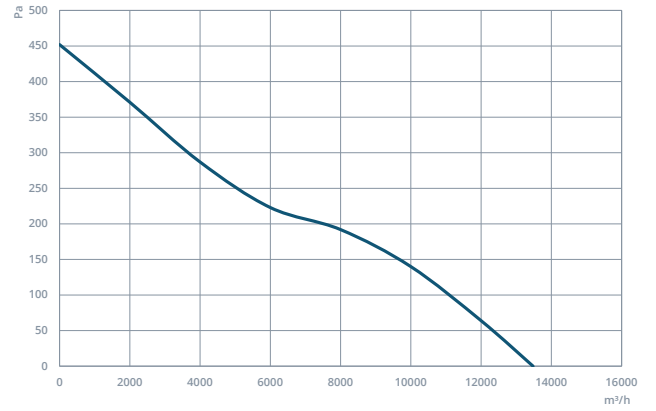

PAXI 710-5-30

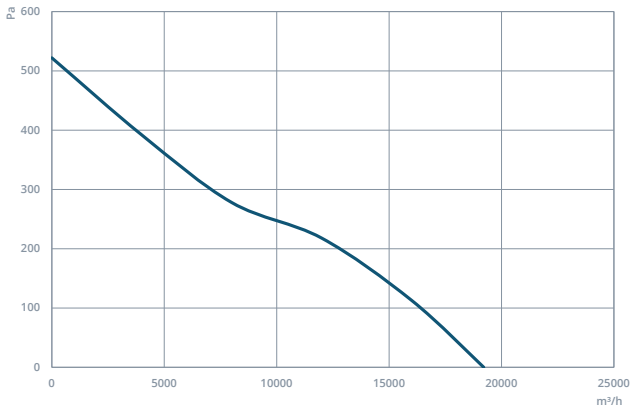

PAXI 800-5-30

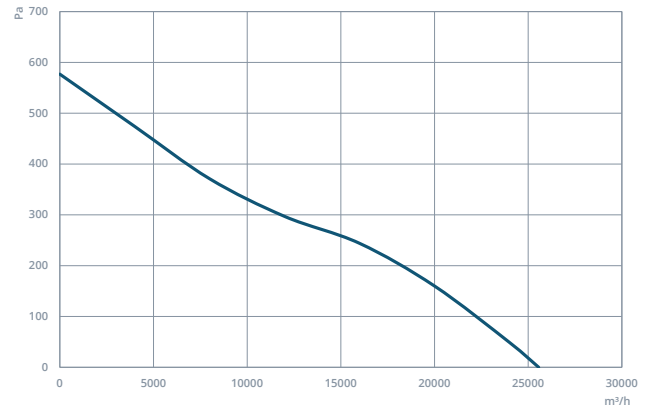

PAXI 800-5-35

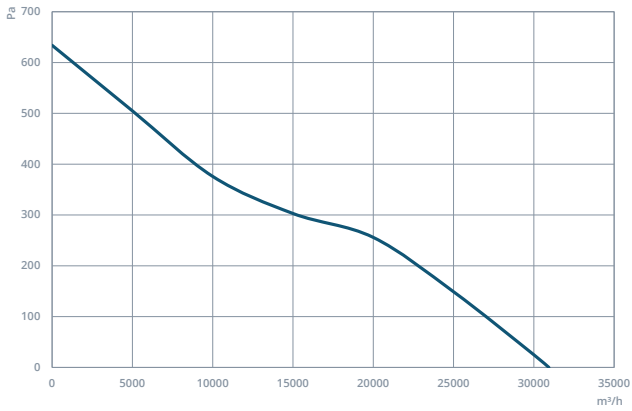

PAXI 900-5-35

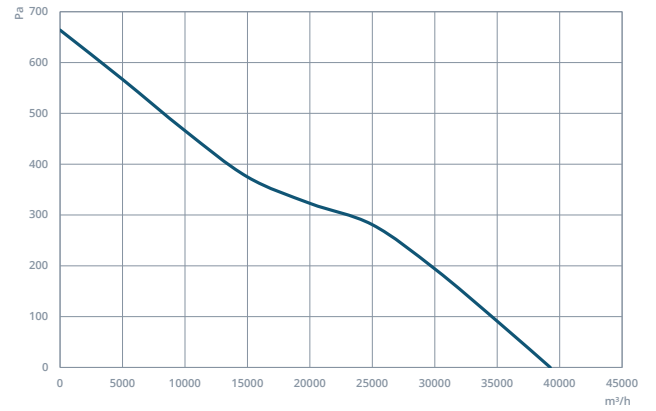

PERFORMANS EĞRİLERİ

PAXI 900-5-40

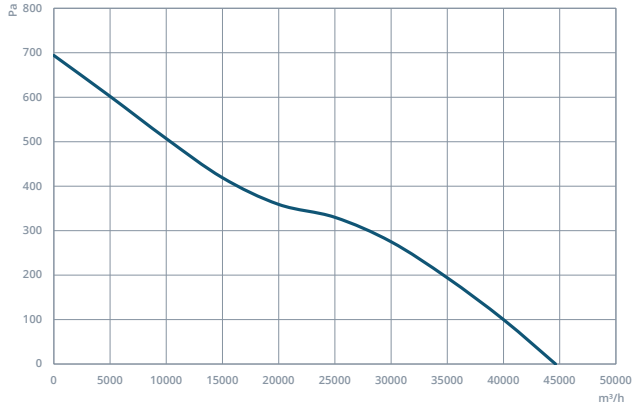

PAXI 1000-5-40

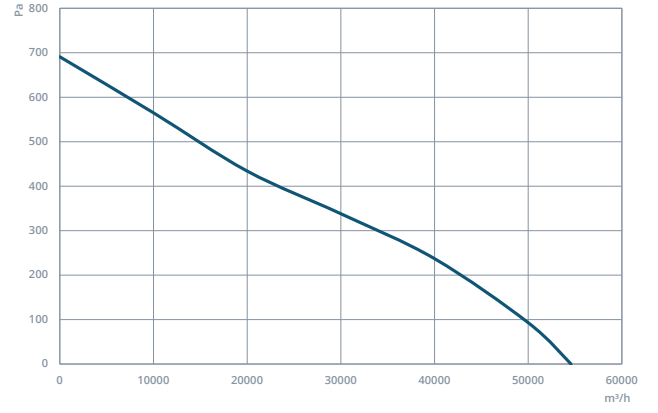

► HAXI - Hücreli Aksiyel Fan

Hücreli aksiyel fanlar kabin içinde olmaları ve kabinin çok yönlü montaja uygun olması nedeniyle zor montaj koşullarında kullanılabilir. Standart aç-kapa anahtarı ve kabin içi susturuculu olarak üretilmektedir.



MOTOR YALITIM SINIFI	F SINIFI
MOTOR KORUMA SINIFI	IP 55
MOTOR VERİM SINIFI	IE3
MOTOR TİPİ	TEFC
MOTOR MARKASI	-
GÖVDE MALZEMESİ	GALVANİZE SAC
GÖVDE KAPLAMASI	YOK
PERVANE MALZEMESİ	ALÜMİNYUM
GÖREV DÖNGÜSÜ	IEC Duty Cycle-S1
ÇALIŞMA SICAKLIĞI	-20 - +50 °C
STANDARTLAR	IEC-60335-2-80, ISO 1940-1



MODEL	VOLTAJ (V)	FREKANS (Hz)	GÜÇ (kW)	DEVİR (d/dk)	DEBİ (m³/h)	SES SEVİYESİ (dB(A))	FİYAT (€/Adet)
HAXI 400-5-25	380	50	0,37	1.450	2.895	60	750,00 €
HAXI 450-5-25	380	50	0,55	1.456	4.180	61	900,00 €
HAXI 500-5-25	380	50	0,55	1.453	5.845	62	1.000,00 €
HAXI 560-5-25	380	50	0,75	1.466	8.150	63	1.150,00 €
HAXI 630-5-30	380	50	1,10	1.465	13.480	64	1.300,00 €
HAXI 710-5-30	380	50	1,50	1.472	19.210	65	1.500,00 €
HAXI 800-5-30	380	50	2,20	1.459	25.560	67	1.650,00 €
HAXI 800-5-35	380	50	3,00	1.463	30.940	69	1.750,00 €
HAXI 900-5-35	380	50	4,00	1.471	39.250	71	2.050,00 €
HAXI 900-5-40	380	50	5,50	1.472	44.635	73	2.400,00 €
HAXI 1000-5-40	380	50	7,50	1.478	54.570	73	2.700,00 €
HAXI 900-8-40	380	50	11,00	1.454	46.200	76	4.000,00 €
HAXI 1000-8-40	380	50	15,00	1.456	62.250	77	4.700,00 €
HAXI 1000-8-45	380	50	18,50	1.458	69.070	78	5.300,00 €
HAXI 1120-8-40	380	50	22,00	1.471	86.620	79	6.000,00 €
HAXI 1120-8-45	380	50	30,00	1.474	95.270	81	8.200,00 €

Değerler 0 Pa içindir

OPSİYONLAR



KORUMA TELİ		TAKOZ		YAY		PANO	
ÖLÇÜ	FİYAT	ÖLÇÜ	FİYAT	ÖLÇÜ	FİYAT	ÖLÇÜ	FİYAT
400	30,00 €	400	48,00 €	400	142,00 €	5,5 kW	570,00 €
450	30,00 €	450	48,00 €	450	142,00 €	7,5 kW	570,00 €
500	37,00 €	500	48,00 €	500	142,00 €	11,0 kW	570,00 €
560	39,00 €	560	48,00 €	560	142,00 €	15,0 kW	951,00 €
630	45,00 €	630	48,00 €	630	142,00 €	18,5 kW	951,00 €
710	60,00 €	710	64,00 €	710	192,00 €	22,0 kW	1.675,00 €
800	75,00 €	800	64,00 €	800	192,00 €	30,0 kW	1.675,00 €
900	94,00 €	900	64,00 €	900	192,00 €		
1000	142,00 €	1000	64,00 €	1000	192,00 €		
1120	163,00 €	1120	64,00 €	1120	192,00 €		

DIĞER OPSİYONLAR



İstenilen Debi ve Basınca Özel Üretim



Sistem Otomasyonu



5, 8, 12 ve 16 Kanat Adedi Seçenekleri

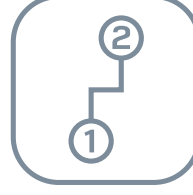

Çift Devirli Motor Seçeneđi



Alüminyum veya Plastik Kanat Seçeneđi



Sıcaklık Dayanımlı Motor Seçeneđi

TEKNİK RESİM

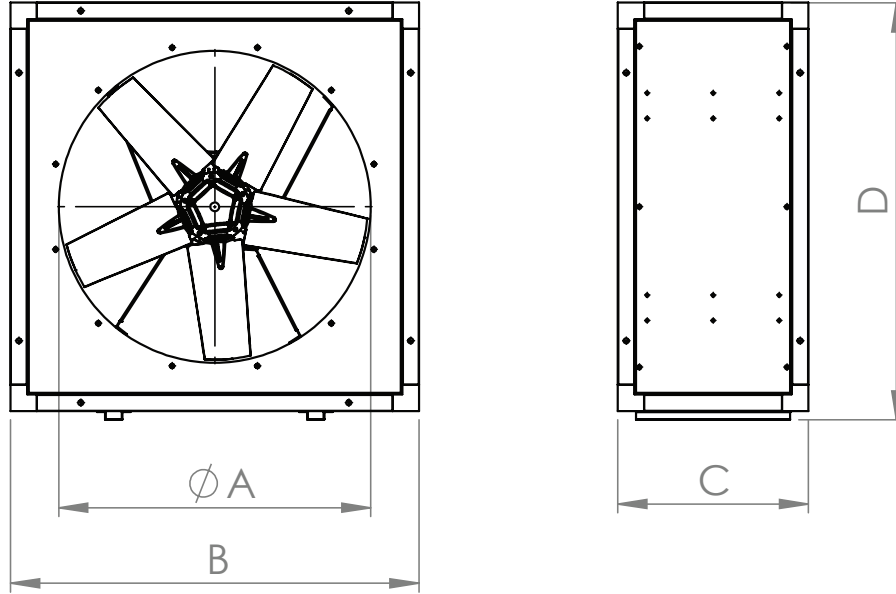

MODEL	A (mm)	B (mm)	C (mm)	D (mm)
HAXI 400	400	620	425	645
HAXI 450	450	670	425	695
HAXI 500	500	720	425	745
HAXI 560	560	780	425	805
HAXI 630	630	850	425	875
HAXI 710	710	930	425	955
HAXI 800	800	1020	425	1045
HAXI 900	900	1120	525	1145
HAXI 1000	1000	1220	525	1245
HAXI 1120	1120	1340	800	1365

PERFORMANS EĞRİLERİ

HAXI 400-5-25

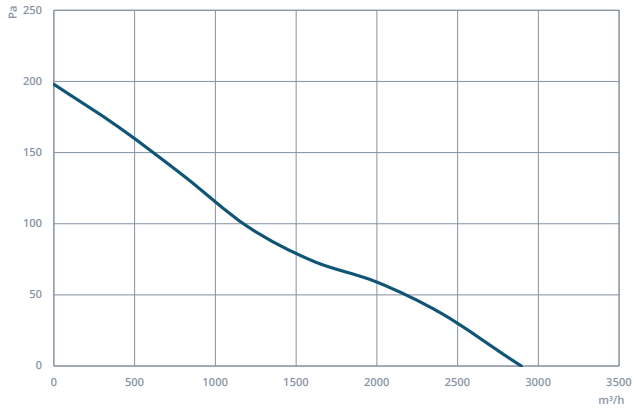

HAXI 450-5-25

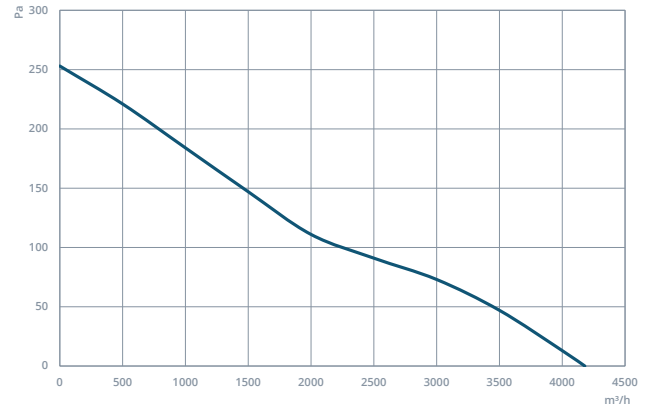

HAXI 500-5-25

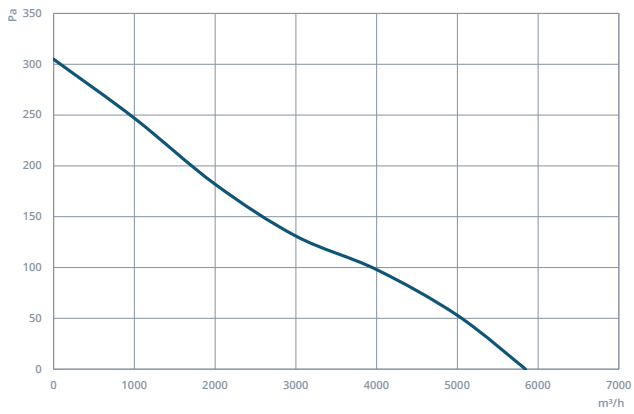

HAXI 560-5-25

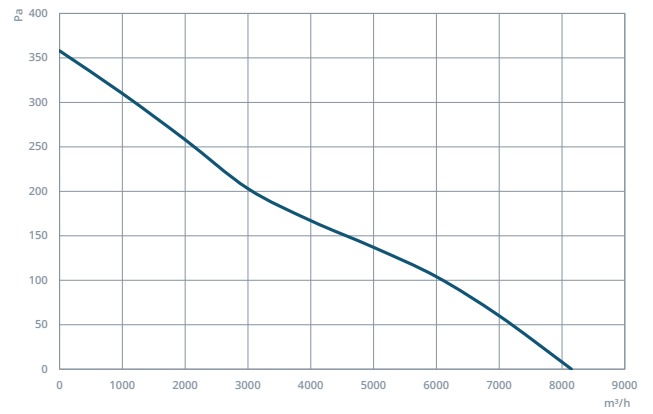

HAXI 630-5-30

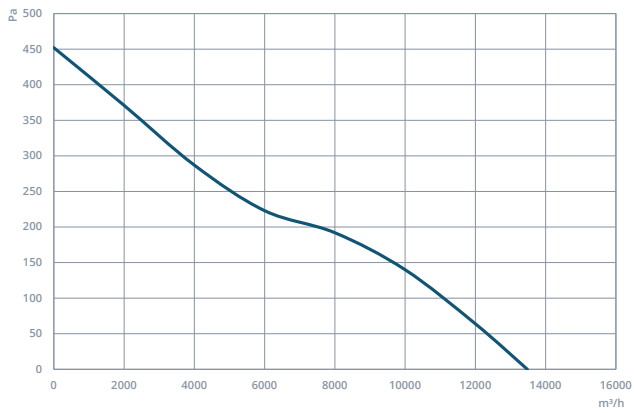

HAXI 710-5-30

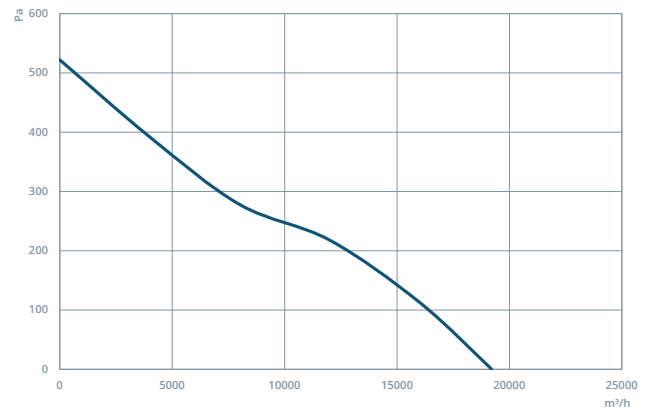

HAXI 800-5-30

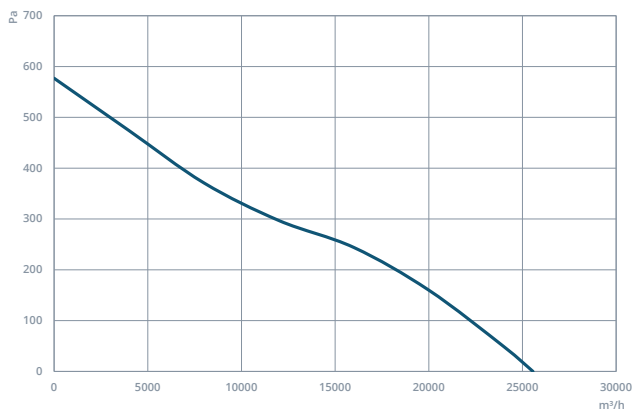

HAXI 800-5-35

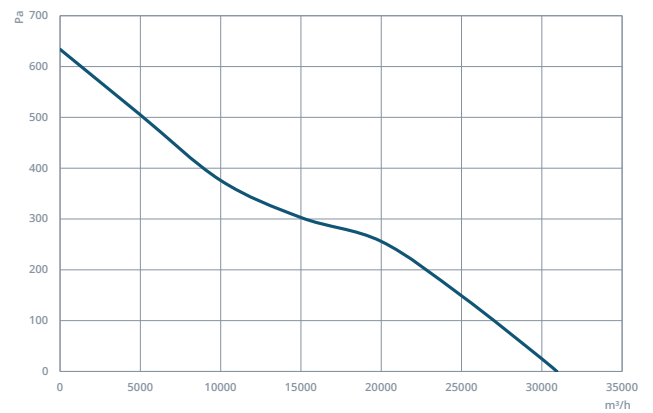

PERFORMANS EĞRİLERİ

HAXI 900-5-35

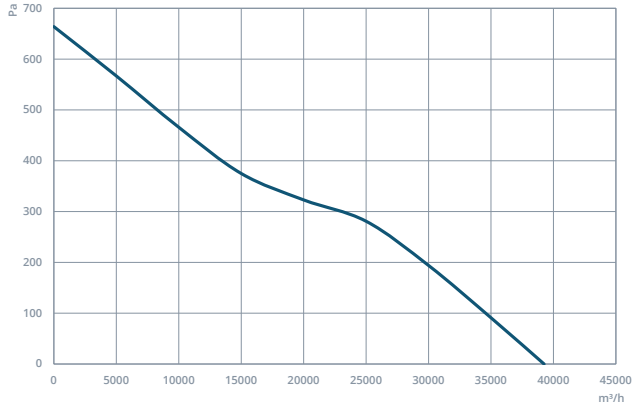

HAXI 900-5-40

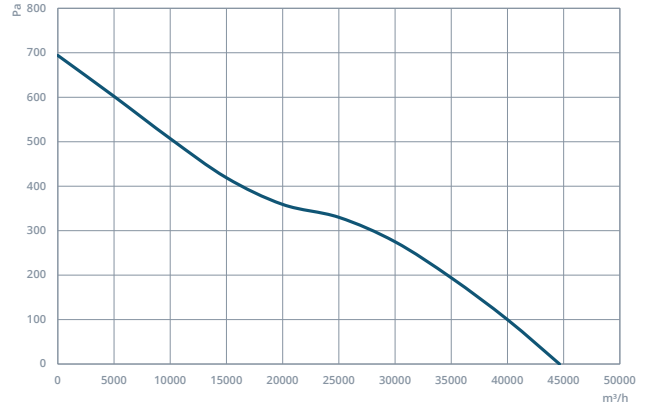

HAXI 1000-5-40

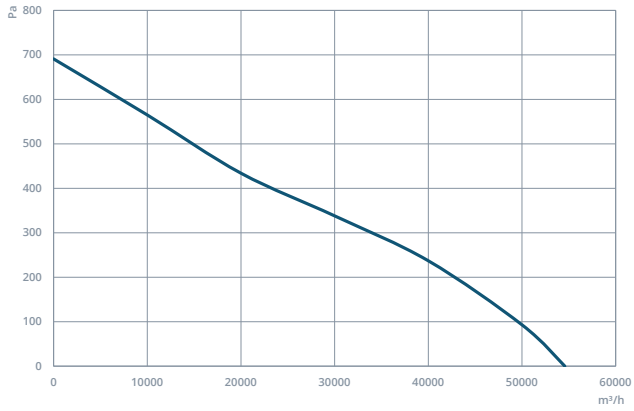

HAXI 900-8-40

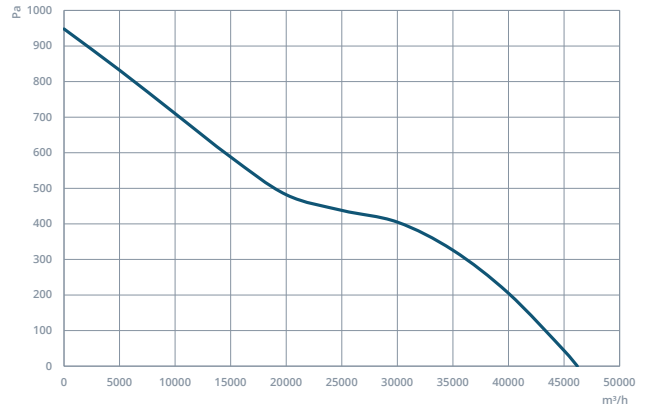

HAXI 1000-8-40

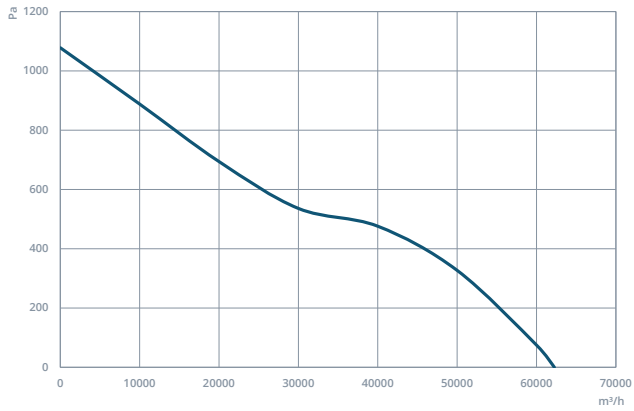

HAXI 1000-8-45

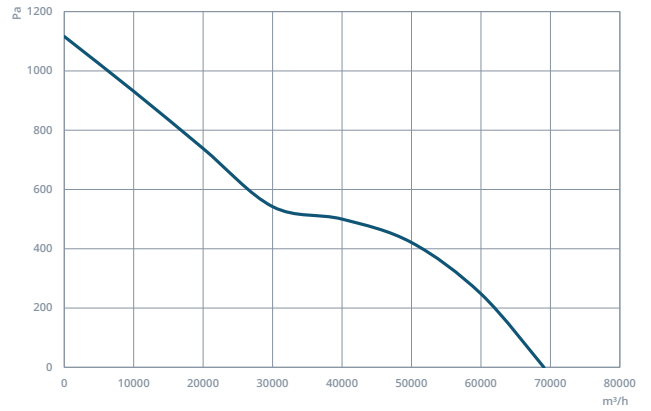

HAXI 1120-8-40

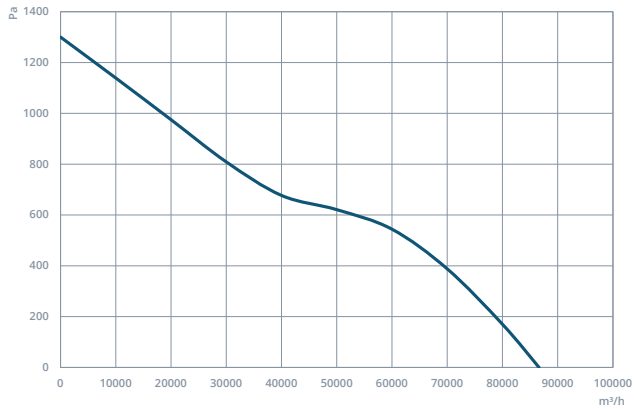

HAXI 1120-8-45

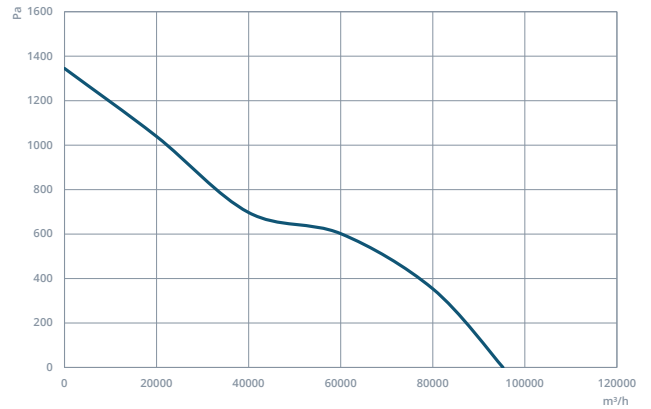

► DAXI - Dıştan Motorlu Kayış-Kasnaklı Aksiyel Fan

Kayış-Kasnaklı Dıştan Motorlu Aksiyel Fanlar motorun hava akımının içinde kalmaması gereken durumlarda kullanılır. Kayış-kasnak sistemi sayesinde üretim aşamasında müşteri isteği doğrultusunda motor devirinin dışında bir devire sabitlenebilir. Montaj ayağı ürünle beraber standart olarak teslim edilmektedir.



MOTOR YALITIM SINIFI	F SINIFI
MOTOR KORUMA SINIFI	IP 55
MOTOR VERİM SINIFI	IE3
MOTOR TİPİ	TEFC
MOTOR MARKASI	-
GÖVDE MALZEMESİ	GALVANİZE SAC
GÖVDE KAPLAMASI	YOK
PERVANE MALZEMESİ	ALÜMİNYUM
GÖREV DÖNGÜSÜ	IEC Duty Cycle-S1
ÇALIŞMA SICAKLIĞI	-20 - +50 °C
STANDARTLAR	IEC-60335-2-80, ISO 1940-1



MODEL	VOLTAJ (V)	FREKANS (Hz)	GÜÇ (kW)	DEVİR (d/dk)	DEBİ (m³/h)	SES SEVİYESİ (dB(A))	FİYAT (€/Adet)
DAXI 400-5-25	380	50	0,37	1.450	2.895	66	810,00 €
DAXI 450-5-25	380	50	0,55	1.456	4.180	69	950,00 €
DAXI 500-5-25	380	50	0,55	1.453	5.845	72	1.000,00 €
DAXI 560-5-25	380	50	0,75	1.466	8.150	75	1.100,00 €
DAXI 630-5-30	380	50	1,10	1.465	13.480	80	1.250,00 €
DAXI 710-5-30	380	50	1,50	1.472	19.210	83	1.450,00 €
DAXI 800-5-30	380	50	2,20	1.459	25.560	85	1.650,00 €
DAXI 800-5-35	380	50	3,00	1.463	30.940	89	1.780,00 €
DAXI 900-5-35	380	50	4,00	1.471	39.250	90	2.100,00 €
DAXI 900-5-40	380	50	5,50	1.472	44.635	93	2.400,00 €
DAXI 1000-5-40	380	50	7,50	1.478	54.570	94	2.600,00 €
DAXI 900-8-40	380	50	11,00	1.454	46.200	94	3.350,00 €
DAXI 1000-8-40	380	50	15,00	1.456	62.250	97	3.880,00 €
DAXI 1000-8-45	380	50	18,50	1.458	69.070	99	4.260,00 €
DAXI 1120-8-40	380	50	22,00	1.471	86.620	100	5.500,00 €
DAXI 1120-8-45	380	50	30,00	1.474	95.270	102	6.800,00 €

Değerler 0 Pa içindir

OPSİYONLAR



KORUMA TELİ		KARŞI FLANŞ		KONNEKTÖR		TAKOZ		YAY		PANO	
ÖLÇÜ	FİYAT	ÖLÇÜ	FİYAT	ÖLÇÜ	FİYAT	ÖLÇÜ	FİYAT	ÖLÇÜ	FİYAT	ÖLÇÜ	FİYAT
400	30,00 €	400	48,00 €	400	107,00 €	400	48,00 €	400	142,00 €	5,5 kW	570,00 €
450	30,00 €	450	52,00 €	450	118,00 €	450	48,00 €	450	142,00 €	7,5 kW	570,00 €
500	37,00 €	500	58,00 €	500	130,00 €	500	48,00 €	500	142,00 €	11,0 kW	570,00 €
560	39,00 €	560	63,00 €	560	142,00 €	560	48,00 €	560	142,00 €	15,0 kW	970,00 €
630	45,00 €	630	69,00 €	630	157,00 €	630	48,00 €	630	142,00 €	18,5 kW	970,00 €
710	60,00 €	710	79,00 €	710	179,00 €	710	64,00 €	710	192,00 €	22,0 kW	1.675,00 €
800	75,00 €	800	93,00 €	800	207,00 €	800	64,00 €	800	192,00 €	30,0 kW	1.675,00 €
900	94,00 €	900	99,00 €	900	222,00 €	900	64,00 €	900	192,00 €		
1000	142,00 €	1000	107,00 €	1000	248,00 €	1000	64,00 €	1000	192,00 €		
1120	163,00 €	1120	124,00 €	1120	279,00 €	1120	64,00 €	1120	192,00 €		

DIĞER OPSİYONLAR



İstenilen Renkte Elektro-Statik Toz Boya



Alüminyum veya Plastik Kanat Seçeneği

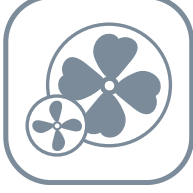

İstenilen Debi ve Basınca Özel Üretim



Sistem Otomasyonu



5, 8, 12 ve 16 Kanat Adedi Seçenekleri

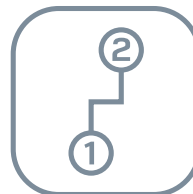

Çift Devirli Motor Seçeneği

TEKNİK RESİM

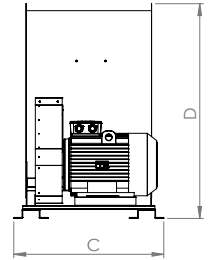
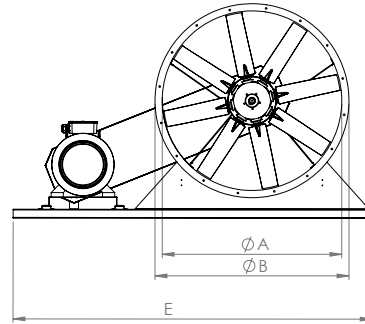
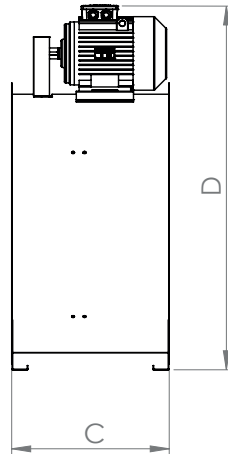
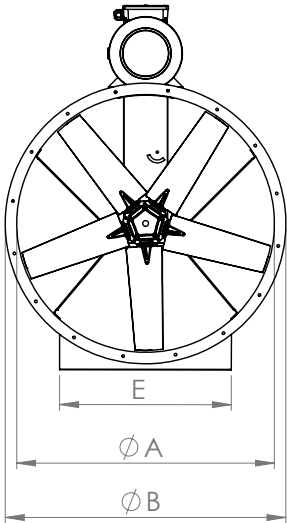

MODEL	A (mm)	B (mm)	C (mm)	D (mm)	E (mm)
DAXI 400	400	480	380	660	300
DAXI 450	450	530	400	720	330
DAXI 500	500	580	400	770	360
DAXI 560	560	640	430	840	400
DAXI 630	630	710	500	925	440
DAXI 710	710	790	500	1005	480
DAXI 800	800	880	500	1110	520
DAXI 900	900	980	740	1360	560
DAXI 1000	1000	1080	740	1470	600

MODEL	A (mm)	B (mm)	C (mm)	D (mm)	E (mm)
DAXI 1000	1000	1080	836	1195	2000
DAXI 1120	1120	1200	956	1315	2000

DAXI 1000-8-45 ve üstündeki modellerde motor fan gövdesinin üstüne konulamadığı için platform üstüne monte edilir.

PERFORMANS EĞRİLERİ

DAXI 400-5-25

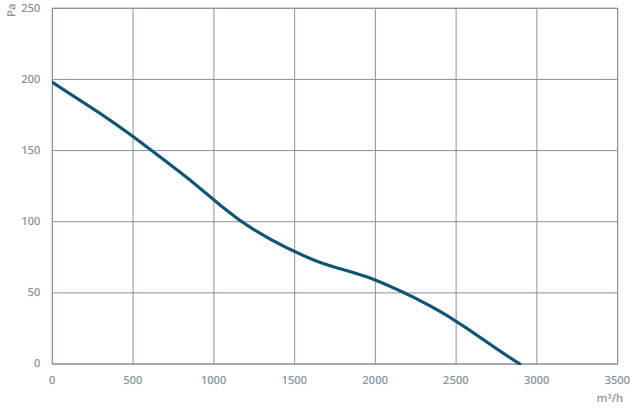

DAXI 450-5-25

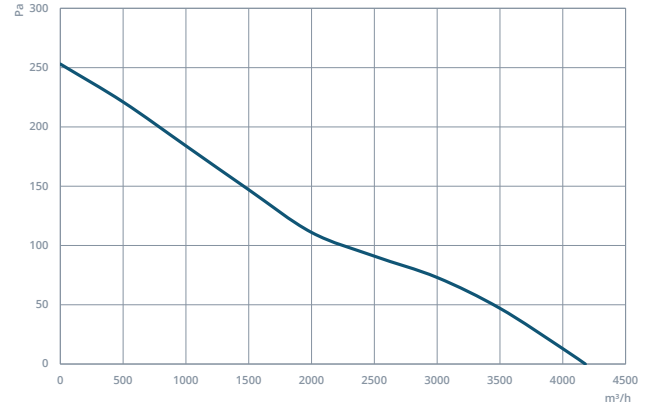

DAXI 500-5-25

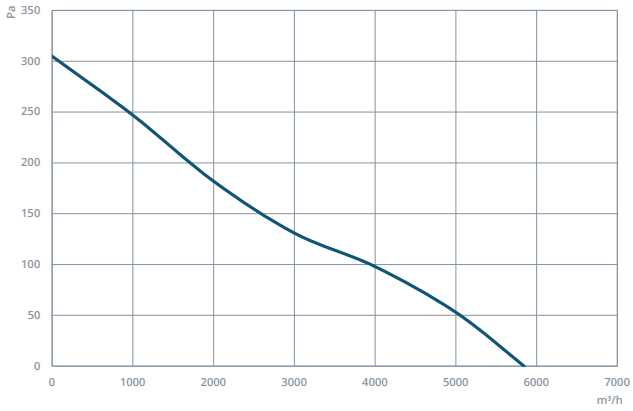

DAXI 560-5-25

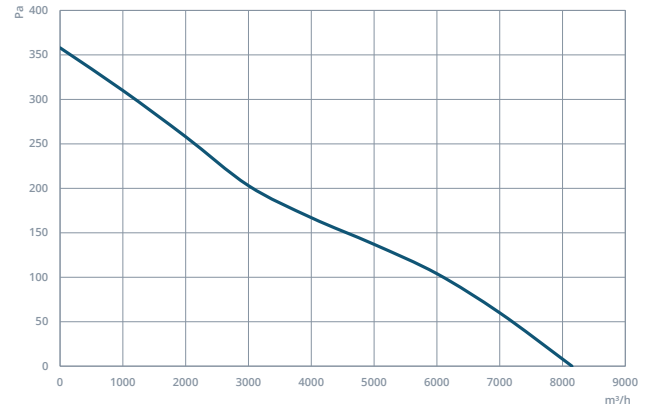

DAXI 630-5-30

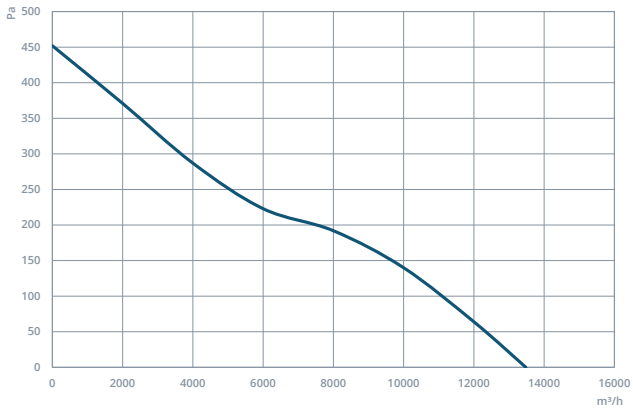

DAXI 710-5-30

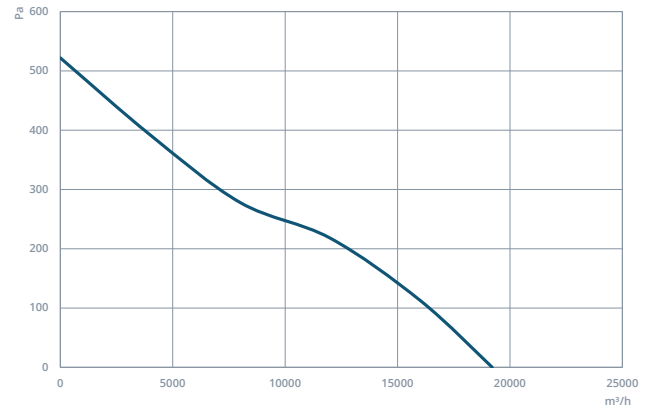

DAXI 800-5-30

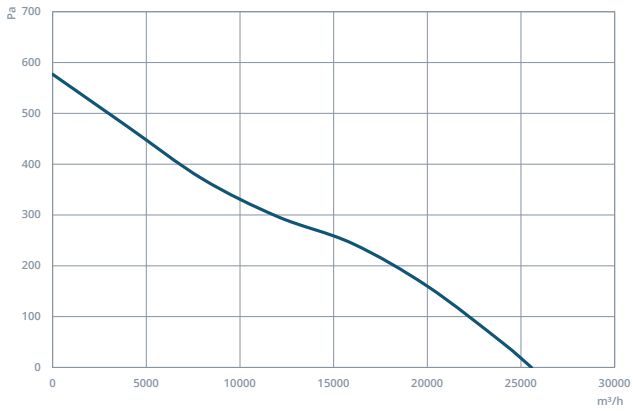

DAXI 800-5-35

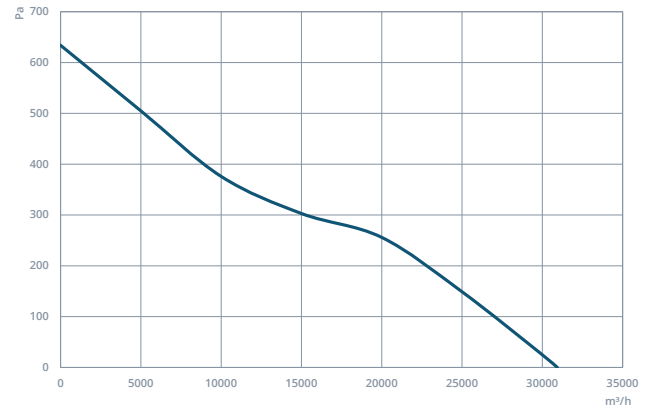

PERFORMANS EĞRİLERİ

DAXI 900-5-35

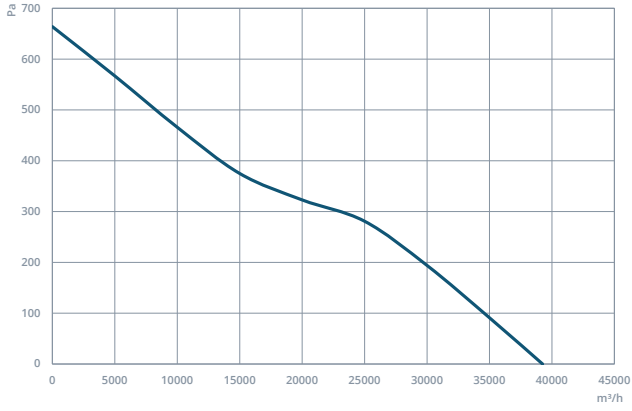

DAXI 900-5-40

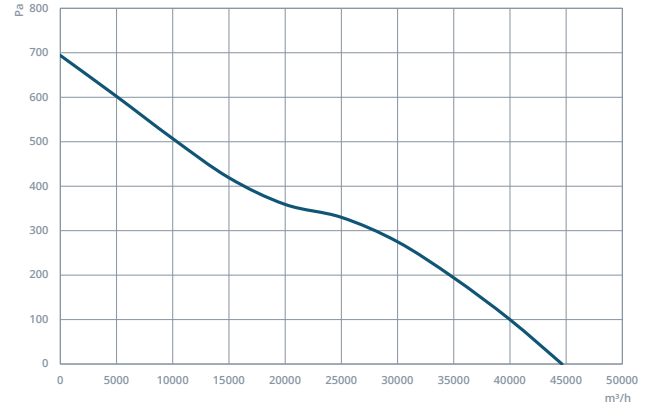

DAXI 1000-5-40

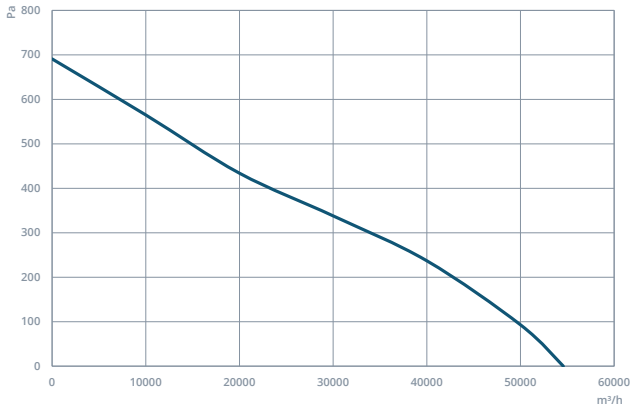

DAXI 900-8-40

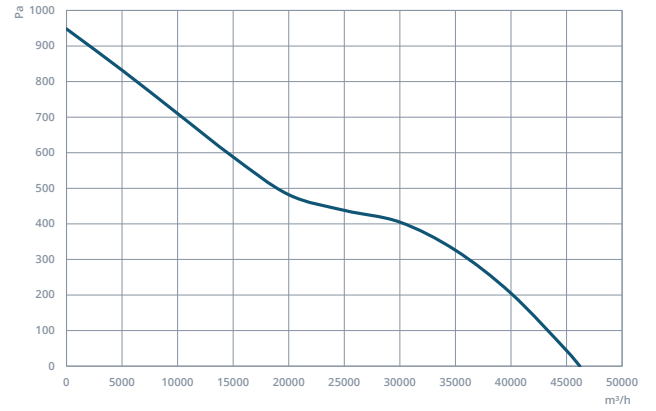

DAXI 1000-8-40

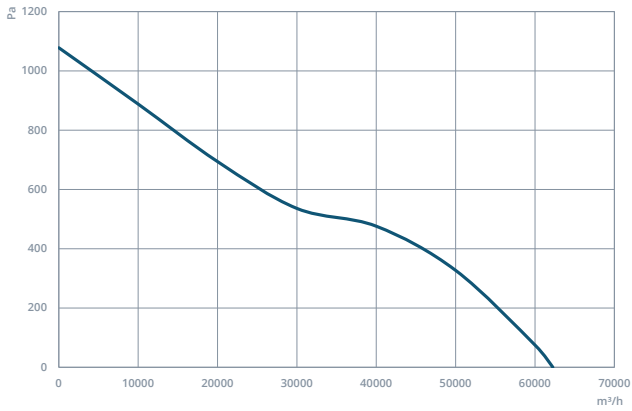

DAXI 1000-8-45

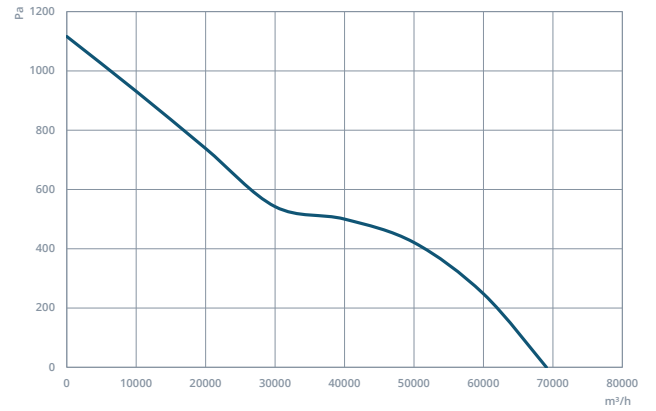

DAXI 1120-8-40

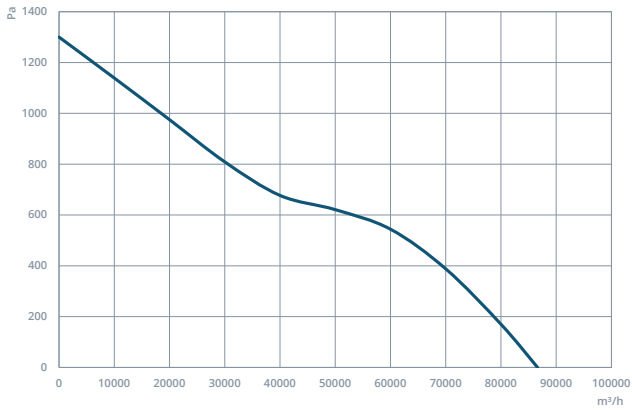

DAXI 1120-8-45

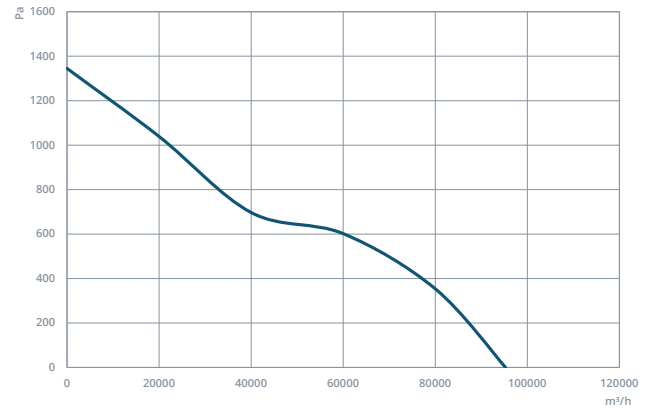

► BAXI - Saklı Motorlu Aksiyel Fan

Saklı motorlu aksiyel fanlar motorun hava akımının dışında kalması gereken ve kayış-kasnak sistemli fanların kullanılmayacağı durumlarda tercih edilir. Sürekli sıcaklık altında çalışmak zorunda olan fanlar için opsiyonel olarak KAZ fanlar ile motor soğutması yapılabilir. Hava akış yönü motordan pervaneye DOĞRUDUR.



MOTOR YALITIM SINIFI	F SINIFI
MOTOR KORUMA SINIFI	IP 55
MOTOR VERİM SINIFI	IE3
MOTOR TİPİ	TEFC
MOTOR MARKASI	-
GÖVDE MALZEMESİ	GALVANİZE SAC
GÖVDE KAPLAMASI	YOK
PERVANE MALZEMESİ	ALÜMİNYUM
GÖREV DÖNGÜSÜ	IEC Duty Cycle-S1
ÇALIŞMA SICAKLIĞI	-20 - +50 °C
STANDARTLAR	IEC-60335-2-80, ISO 1940-1



MODEL	VOLTAJ (V)	FREKANS (Hz)	GÜÇ (kW)	DEVİR (d/dk)	DEBİ (m³/h)	SES SEVİYESİ (dB(A))	FİYAT (€/Adet)
BAXI 710-5-30	380	50	1,50	1.472	17000	83	1.300,00 €
BAXI 800-5-30	380	50	2,20	1.459	22.250	85	1.450,00€
BAXI 800-5-35	380	50	3,00	1.463	26.940	89	1.600,00 €
BAXI 900-5-35	380	50	4,00	1.471	34.150	90	1.780,00 €
BAXI 900-5-40	380	50	5,50	1.472	40.000	93	2.190,00 €
BAXI 1000-5-40	380	50	7,50	1.478	49.570	94	2.510,00 €
BAXI 900-8-40	380	50	11,00	1.454	43.200	94	3.780,00 €
BAXI 1000-8-40	380	50	15,00	1.456	58.850	97	4.230,00 €
BAXI 1000-8-45	380	50	18,50	1.458	66.070	99	4.850,00 €
BAXI 1120-8-40	380	50	22,00	1.471	84.620	100	6.000,00 €
BAXI 1120-8-45	380	50	30,00	1.474	92.270	102	7.550,00 €

Değerler 0 Pa içindir

OPSİYONLAR



KORUMA TELİ		MONTAJ AYAĞI		KARŞI FLANŞ		KONNEKTÖR		TAKOZ		YAY		PANO	
ÖLÇÜ	FIYAT	ÖLÇÜ	FIYAT	ÖLÇÜ	FIYAT	ÖLÇÜ	FIYAT	ÖLÇÜ	FIYAT	ÖLÇÜ	FIYAT	ÖLÇÜ	FIYAT
710	60,00 €	710	54,00 €	710	79,00 €	710	179,00€	710	64,00 €	710	192,00 €	5,5 kW	570,00 €
800	75,00 €	800	69,00 €	800	93,00 €	800	207,00 €	800	64,00 €	800	192,00 €	7,5 kW	570,00 €
900	94,00 €	900	85,00 €	900	99,00 €	900	222,00 €	900	64,00 €	900	192,00 €	11,0 kW	570,00 €
1000	142,00 €	1000	127,00 €	1000	107,00 €	1000	248,00 €	1000	64,00 €	1000	192,00 €	15,0 kW	970,00 €
1120	163,00 €	1120	127,00 €	1120	124,00 €	1120	279,00 €	1120	64,00 €	1120	192,00 €	18,5 kW	970,00 €
												22,0 kW	1.675,00 €
												30,0 kW	1.675,00 €

DIĞER OPSİYONLAR



İstenilen Renkte Elektro-Statik Toz Boya



Alüminyum veya Plastik Kanat Seçeneği

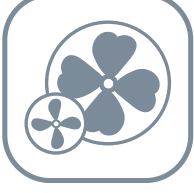

İstenilen Debi ve Basınca Özel Üretim



Sistem Otomasyonu



5, 8, 12 ve 16 Kanat Adedi Seçenekleri

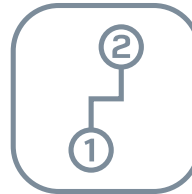

Çift Devirli Motor Seçeneği

TEKNİK RESİM

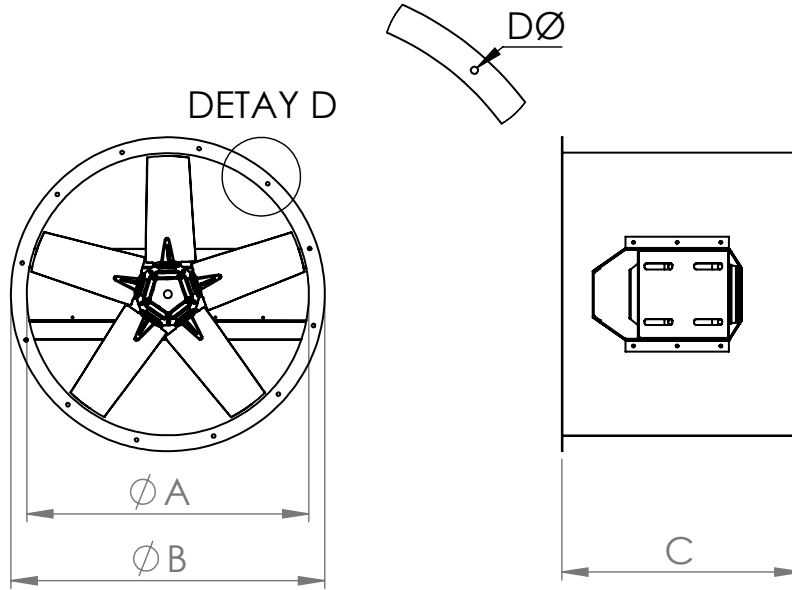

MODEL	A (mm)	B (mm)	C (mm)	D (mm)	N (Delik Sayısı)
BAXI 710	710	790	600	11	12
BAXI 800	800	880	650	11	16
BAXI 900	900	980	700	11	16
BAXI 1000	1000	1080	740	11	16
BAXI 1120	1120	1200	800	11	16

PERFORMANS EĞRİLERİ

BAXI 710-5-30

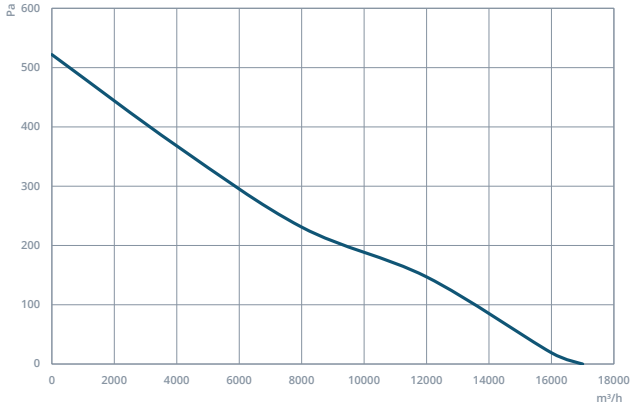

BAXI 800-5-30

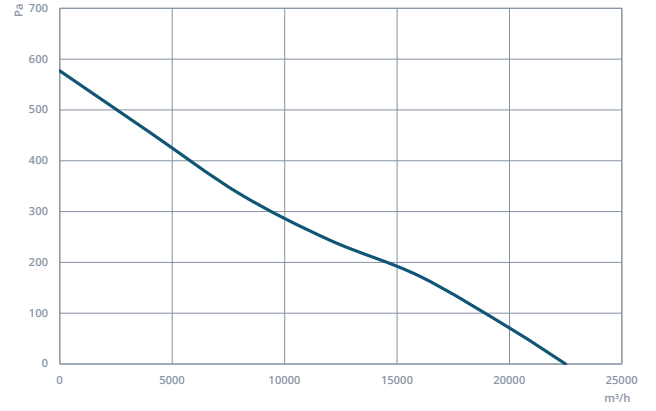

BAXI 800-5-35

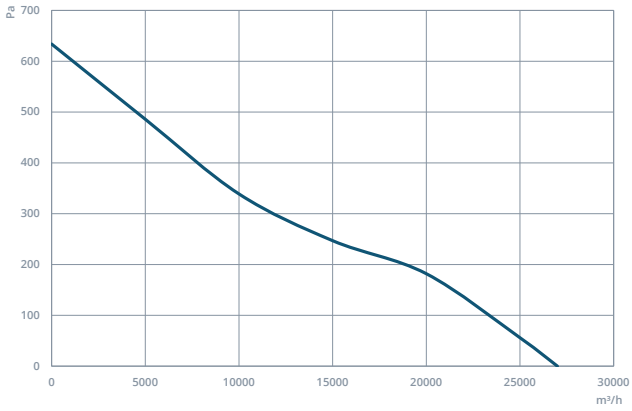

BAXI 900-5-35

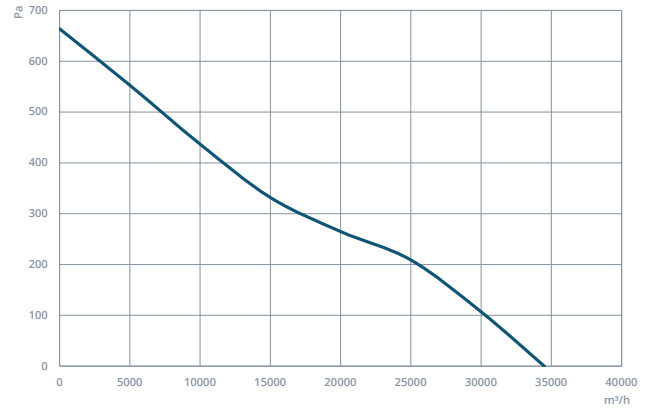

BAXI 900-5-40

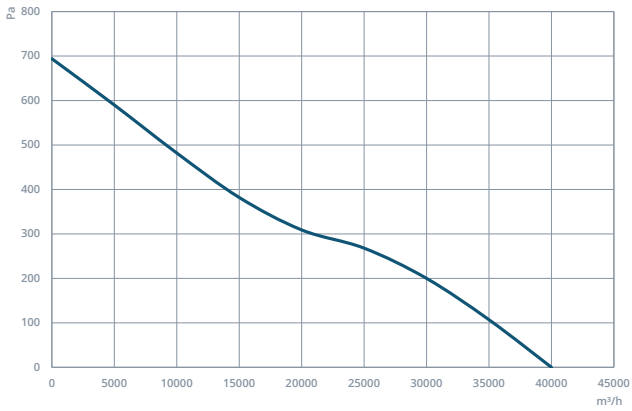

BAXI 1000-5-40

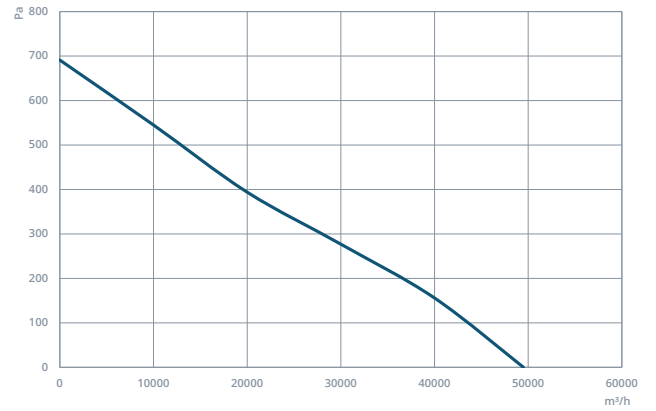

BAXI 900-8-40

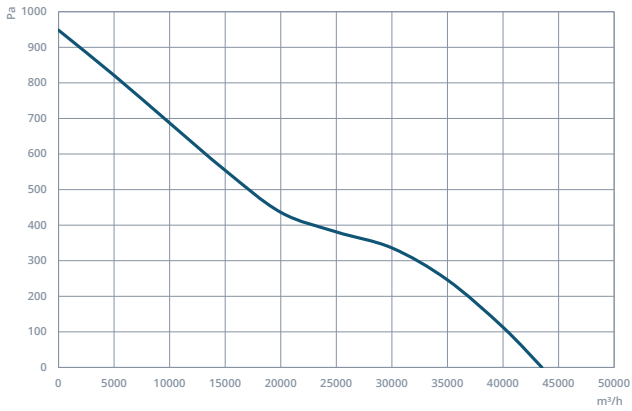

BAXI 1000-8-40

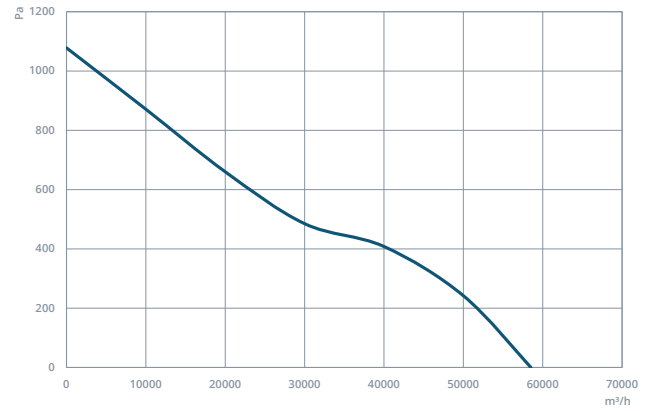

PERFORMANS EĞRİLERİ

BAXI 1000-8-45

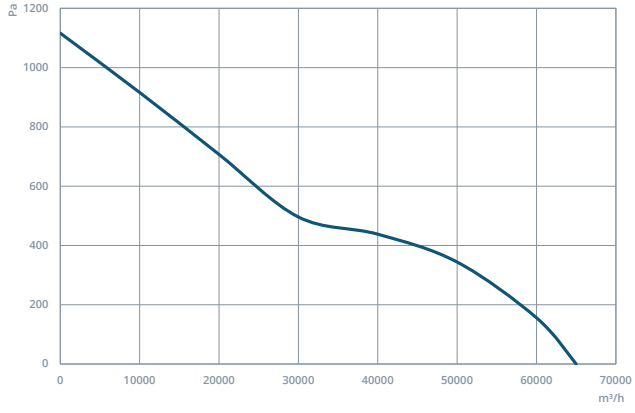

BAXI 1120-8-40

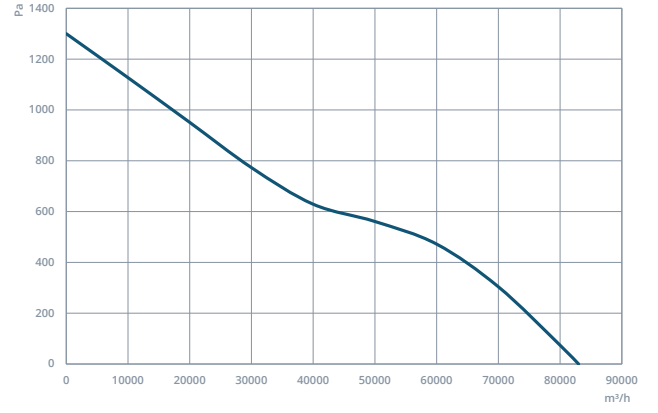

BAXI 1120-8-45

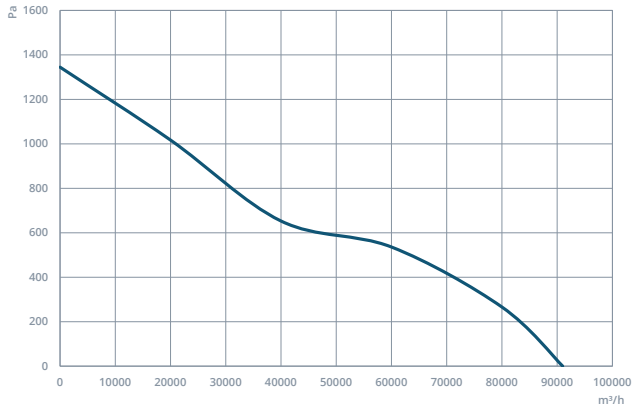

► GAXI - Mobil Aksiyel Fan

Mobil aksiyel fanlar tekerlekli taşıyıcıları sayesinde istediğiniz yere götürebileceğiniz, dümeni ile üfleme yönünü ayarlayabileceğiniz, ve panosundaki açma, kapama ve acil durum düğmeleri ile kontrol edebileceğiniz hareketli havalandırma çözümdür. Standart olarak koruma teli ile teslim edilir.



MOTOR YALITIM SINIFI	F SINIFI
MOTOR KORUMA SINIFI	IP 55
MOTOR VERİM SINIFI	IE3
MOTOR TİPİ	TEFC
MOTOR MARKASI	-
GÖVDE MALZEMESİ	GALVANİZE SAC
GÖVDE KAPLAMASI	ELEKTRO-STATİK TOZ BOYA
PERVANE MALZEMESİ	ALÜMİNYUM
GÖREV DÖNGÜSÜ	IEC Duty Cycle-S1
ÇALIŞMA SICAKLIĞI	-20 - +50 °C
STANDARTLAR	IEC-60335-2-80, ISO 1940-1



MODEL	VOLTAJ (V)	FREKANS (Hz)	GÜÇ (kW)	DEVİR (d/dk)	DEBİ (m ³ /h)	SES SEVİYESİ (dB(A))	FİYAT (€/Adet)
GAXI 560-5-25	380	50	0,75	1.466	8.150	75	1.100,00 €
GAXI 630-5-30	380	50	1,10	1.465	13.480	80	1.250,00 €
GAXI 710-5-30	380	50	1,50	1.472	19.210	83	1.480,00 €
GAXI 800-5-30	380	50	2,20	1.459	25.560	85	1.650,00 €

Değerler 0 Pa içindir

TEKNİK RESİM

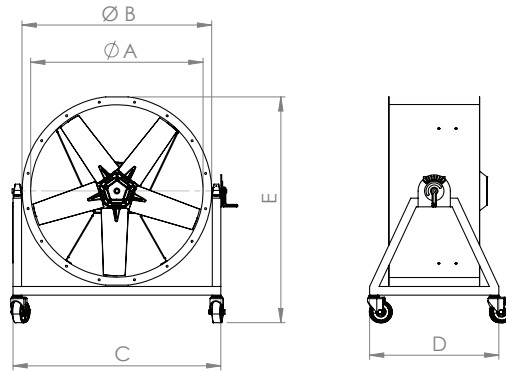

MODEL	A (mm)	B (mm)	C (mm)	D (mm)	E (mm)
GAXI 560	560	640	760	500	860
GAXI 630	630	710	830	600	930
GAXI 710	710	790	910	600	1010
GAXI 800	800	880	1000	600	1100

DIĞER OPSİYONLAR



İstenilen Renkte Elektro-Statik Toz Boya



Alüminyum veya Plastik Kanat Seçeneği

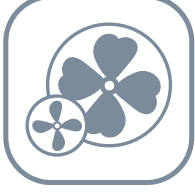

İstenilen Debi ve Basınca Özel Üretim



Sistem Otomasyonu



5, 8, 12 ve 16 Kanat Adedi Seçenekleri

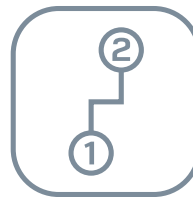

Çift Devirli Motor Seçeneği

PERFORMANS EĞRİLERİ

GAXI 560-5-25

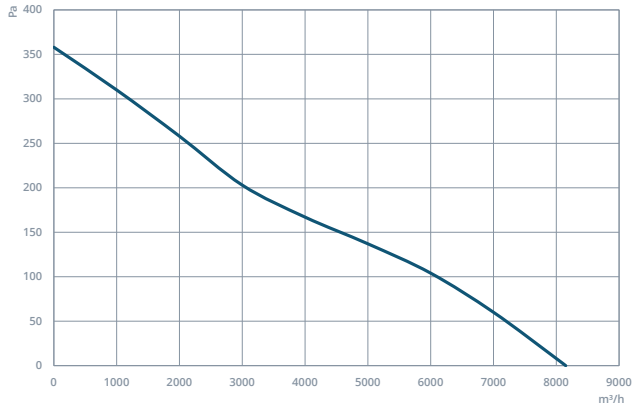

GAXI 630-5-30

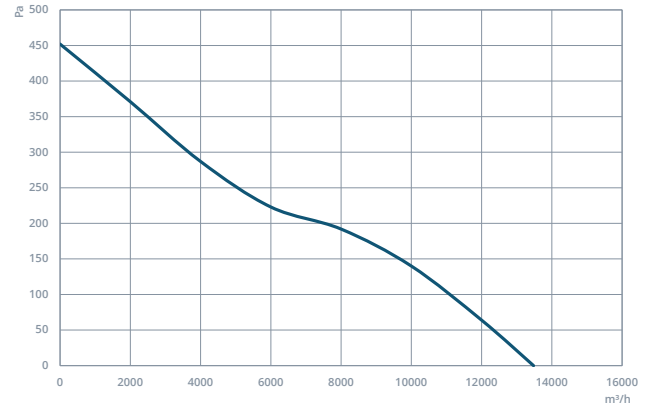

GAXI 710-5-30

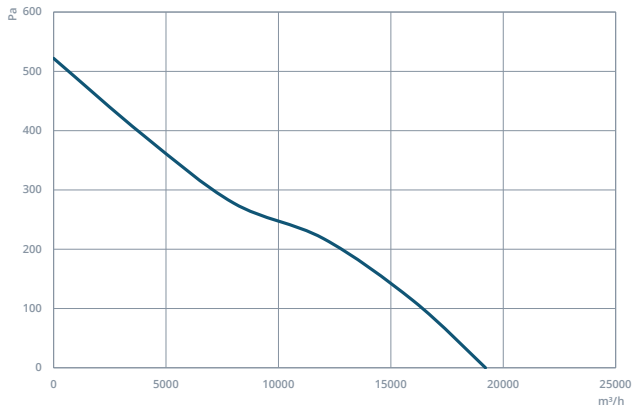

GAXI 800-5-30

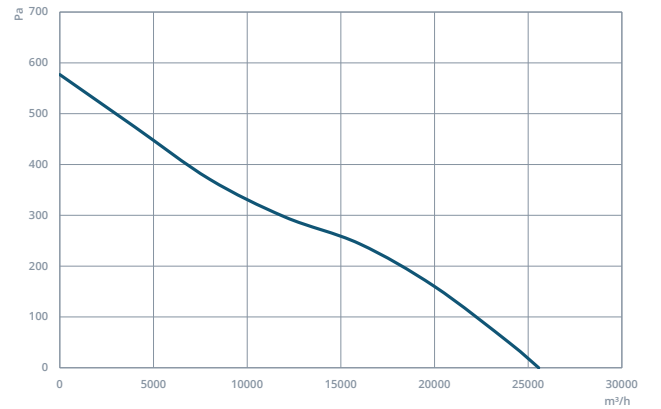

► AXIP - Plastik Kanatlı Aksiyel Fan

AXIP Fan kare gövdesi ile duvara kolay montaj imkanı sağlar. Standart olarak koruma teli ve elektrostatik toz boyalı üretilir. İsteğe göre kanatlar alüminyum takılabilir. Hava akış yönü motordan pervaneye DOĞRUDUR.



MOTOR YALITIM SINIFI	F SINIFI
MOTOR KORUMA SINIFI	IP 55
MOTOR VERİM SINIFI	IE3
MOTOR TİPİ	TEFC
MOTOR MARKASI	-
GÖVDE MALZEMESİ	GALVANİZE SAC
GÖVDE KAPLAMASI	ELEKTRO-STATİK TOZ BOYA
PERVANE MALZEMESİ	PLASTİK
GÖREV DÖNGÜSÜ	IEC Duty Cycle-S1
ÇALIŞMA SICAKLIĞI	-20 - +50 °C
STANDARTLAR	IEC-60335-2-80, ISO 1940-1



MODEL	VOLTAJ (V)	FREKANS (Hz)	GÜÇ (kW)	DEVİR (d/dk)	DEBİ (m³/h)	SES SEVİYESİ (dB(A))	FİYAT (€/Adet)
AXIP 400-5-25	380	50	0,37	1450	2.895	66	365,00 €
AXIP 450-5-25	380	50	0,55	1456	4.180	69	428,00 €
AXIP 500-5-25	380	50	0,55	1453	5.845	72	446,00 €
AXIP 560-5-25	380	50	0,75	1466	8.150	75	514,00 €
AXIP 630-5-30	380	50	1,10	1465	13.480	80	614,00 €
AXIP 710-5-30	380	50	1,50	1472	19.210	83	703,00 €
AXIP 800-5-30	380	50	2,20	1459	25.560	85	836,00 €
AXIP 800-5-35	380	50	3,00	1463	30.940	89	926,00 €
AXIP 900-5-35	380	50	4,00	1471	39.250	90	1.148,00 €
AXIP 900-5-40	380	50	5,50	1472	44.635	93	1.363,00 €
AXIP 1000-5-40	380	50	7,50	1478	54.570	94	1.534,00 €

Değerler 0 Pa içindir

TEKNİK RESİM

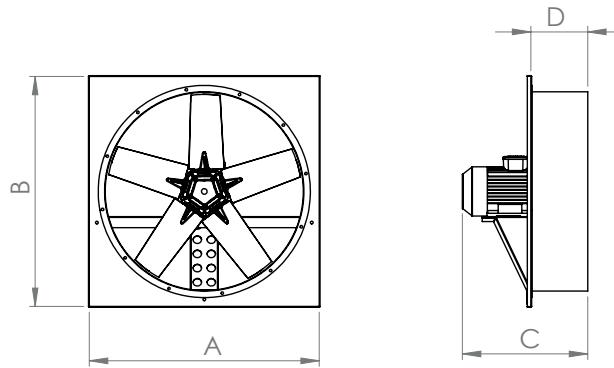

MODEL	A (mm)	B (mm)	C (mm)	D (mm)
AXIP 400	570	570	400	200
AXIP 450	610	610	410	200
AXIP 500	650	650	410	200
AXIP 560	680	680	410	200
AXIP 630	750	750	420	200
AXIP 710	830	830	450	200
AXIP 800	920	920	480	200
AXIP 900	1020	1020	590	300
AXIP 1000	1120	1120	700	300

DIĞER OPSİYONLAR



İstenilen Renkte Elektro-Statik Toz Boya



Alüminyum veya Plastik Kanat Seçeneđi

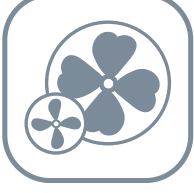

İstenilen Debi ve Basınca Özel Üretim



Sistem Otomasyonu



5, 8, 12 ve 16 Kanat Adedi Seçenekleri

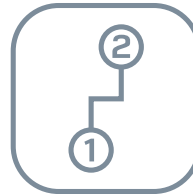

Çift Devirli Motor Seçeneđi

PERFORMANS EĐRİLERİ

AXIP 400-5-25

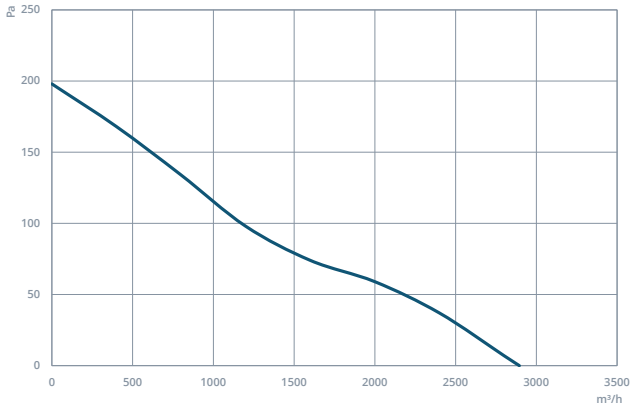

AXIP 450-5-25

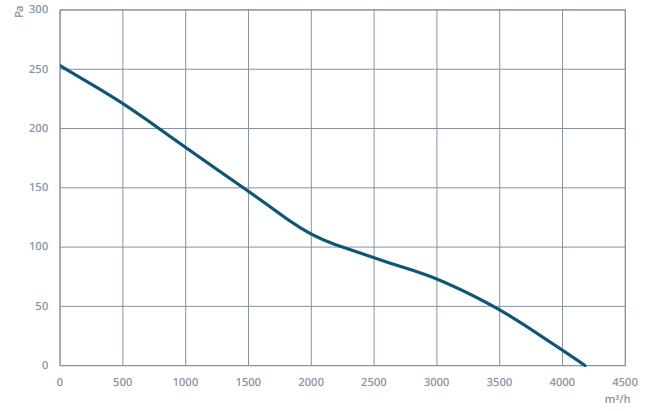

AXIP 500-5-25

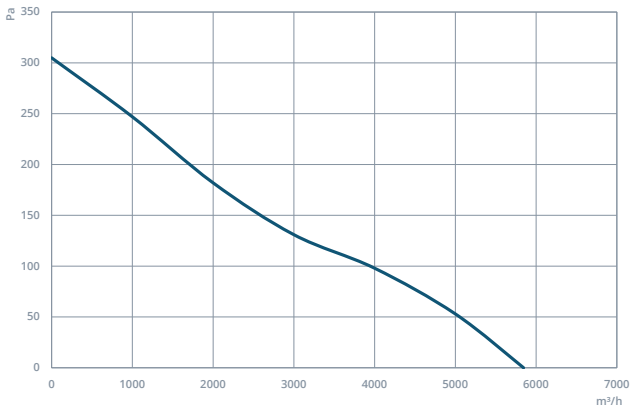

AXIP 560-5-25

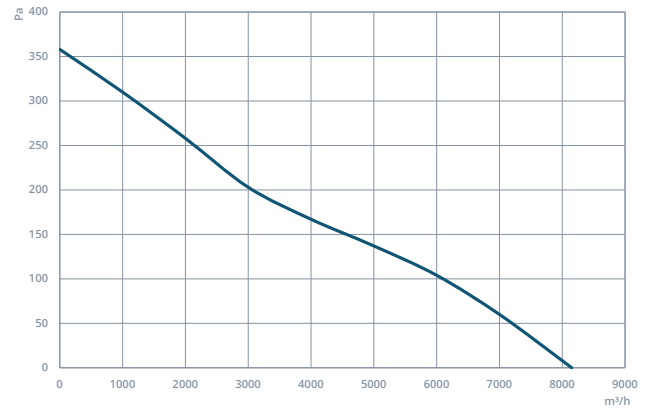

PERFORMANS EĞRİLERİ

AXIP 630-5-30

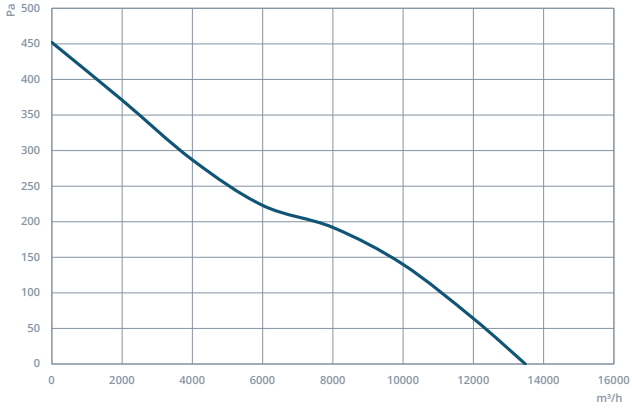

AXIP 710-5-30

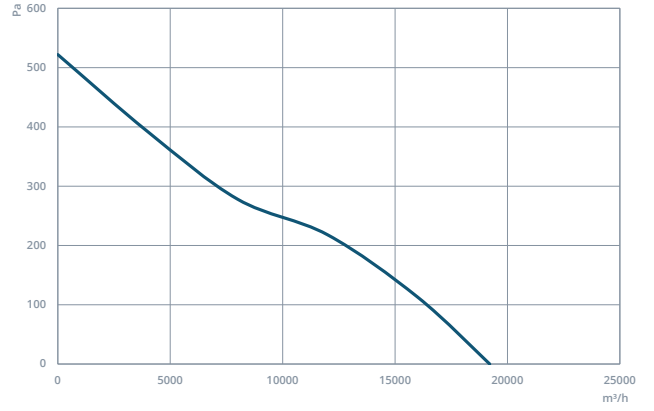

AXIP 800-5-30

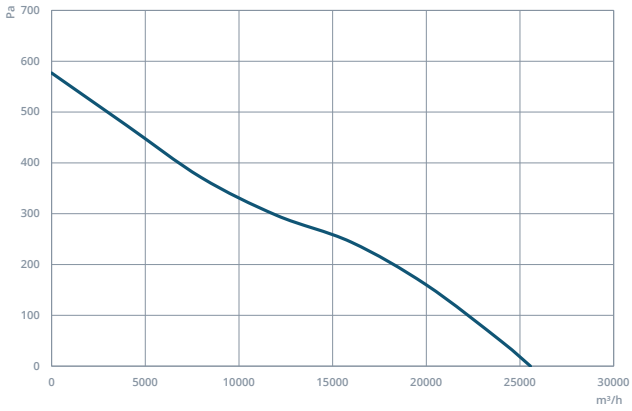

AXIP 800-5-35

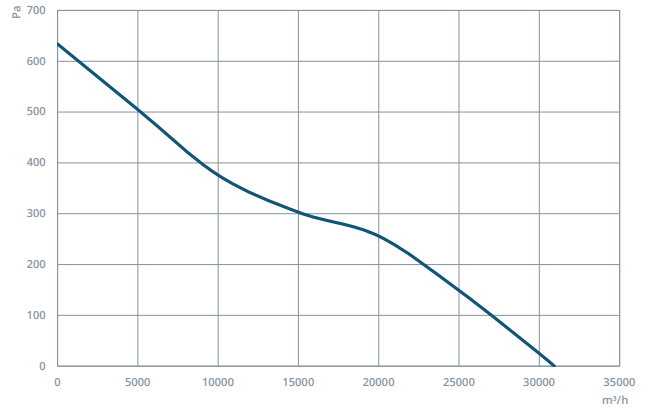

AXIP 900-5-35

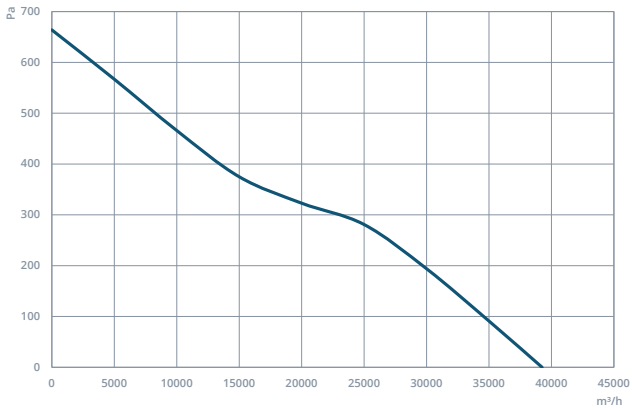

AXIP 900-5-40

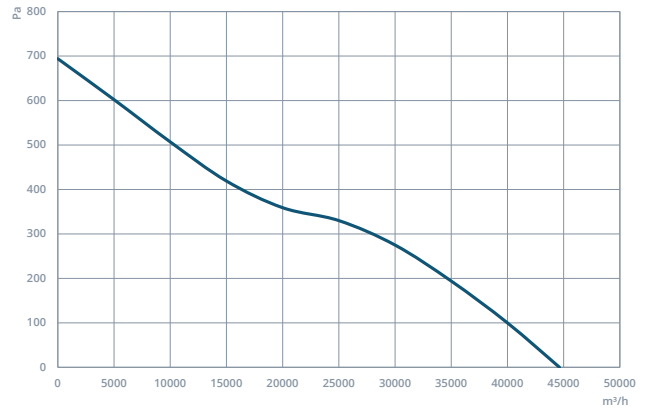

AXIP 1000-5-40

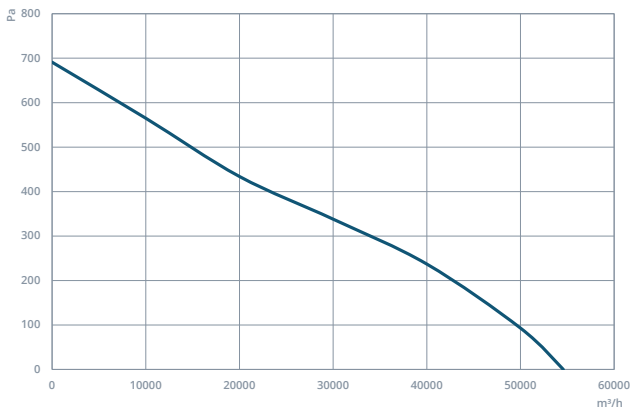

K **ÇATI**
DEPO
O **FABRİKA**

L
A HAVA
LAN
YDIRMA

► CAXI - Çatı Tipi Aksiyel Fan

Çatı Tipi Aksiyel basınçlandırma fanları merdiven, asansör boşluğu vb. gibi basınçlandırma ve emiş ihtiyaçlarını karşılamak için kullanılabilir. Motoru yağmurdan koruyan tavan sacı ve elektrostatik toz boyası sayesinde dış ortam şartlarında uzun yıllar çalışabilir.



MOTOR YALITIM SINIFI	F SINIFI
MOTOR KORUMA SINIFI	IP 55
MOTOR VERİM SINIFI	IE3
MOTOR TİPİ	TEFC
MOTOR MARKASI	-
GÖVDE MALZEMESİ	GALVANİZE SAC
GÖVDE KAPLAMASI	ELEKTRO-STATİK TOZ BOYA
PERVANE MALZEMESİ	ALÜMİNYUM
GÖREV DÖNGÜSÜ	IEC Duty Cycle-S1
ÇALIŞMA SICAKLIĞI	-20 - +50 °C
STANDARTLAR	IEC-60335-2-80, ISO 1940-1



MODEL	VOLTAJ (V)	FREKANS (Hz)	GÜÇ (kW)	DEVİR (d/dk)	DEBİ (m³/h)	SES SEVİYESİ (dB(A))	FİYAT (€/Adet)
CAXI 400-5-25	380	50	0,37	1.450	1.200	66	568,00 €
CAXI 450-5-25	380	50	0,55	1.456	2.200	69	612,00 €
CAXI 500-5-25	380	50	0,55	1.453	3.950	72	653,00 €
CAXI 560-5-25	380	50	0,75	1.466	6.100	75	850,00 €
CAXI 630-5-30	380	50	1,10	1.465	11.000	80	960,00 €
CAXI 710-5-30	380	50	1,50	1.472	17.000	83	1.109,00 €
CAXI 800-5-30	380	50	2,20	1.459	22.250	85	1.388,00 €
CAXI 800-5-35	380	50	3,00	1.463	26.940	89	1.447,00 €
CAXI 900-5-35	380	50	4,00	1.471	34.150	90	1.850,00 €
CAXI 900-5-40	380	50	5,50	1.472	40.000	93	2.100,00 €
CAXI 1000-5-40	380	50	7,50	1.478	49.570	94	2.347,00 €
CAXI 900-8-40	380	50	11,00	1.454	43.200	94	2.682,00 €
CAXI 1000-8-40	380	50	15,00	1.456	58.850	97	3.320,00 €
CAXI 1000-8-45	380	50	18,50	1.458	66.070	99	3.850,00 €
CAXI 1120-8-40	380	50	22,00	1.471	84.620	100	5.600,00 €
CAXI 1120-8-45	380	50	30,00	1.474	92.270	102	6.500,00 €

Değerler 0 Pa içindir

OPSİYONLAR



DAMPER		PANO	
ÖLÇÜ	FİYAT	ÖLÇÜ	FİYAT
400	117,00 €	5,5 kW	570,00 €
450	139,00 €	7,5 kW	570,00 €
500	168,00 €	11,0 kW	570,00 €
560	198,00 €	15,0 kW	970,00 €
630	260,00 €	18,5 kW	970,00 €
710	337,00 €	22,0 kW	1.675,00 €
800	417,00 €	30,0 kW	1.675,00 €
900	509,00 €		
1000	614,00 €		
1120	723,00 €		

DIĞER OPSİYONLAR



İstenilen Renkte Elektro-Statik Toz Boya



Alüminyum veya Plastik Kanat Seçeneđi

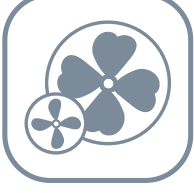

İstenilen Debi ve Basınca Özel Üretim



Sistem Otomasyonu



5, 8, 12 ve 16 Kanat Adedi Seçenekleri

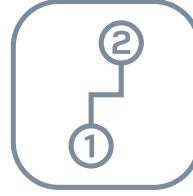

Çift Devirli Motor Seçeneđi

TEKNİK RESİM

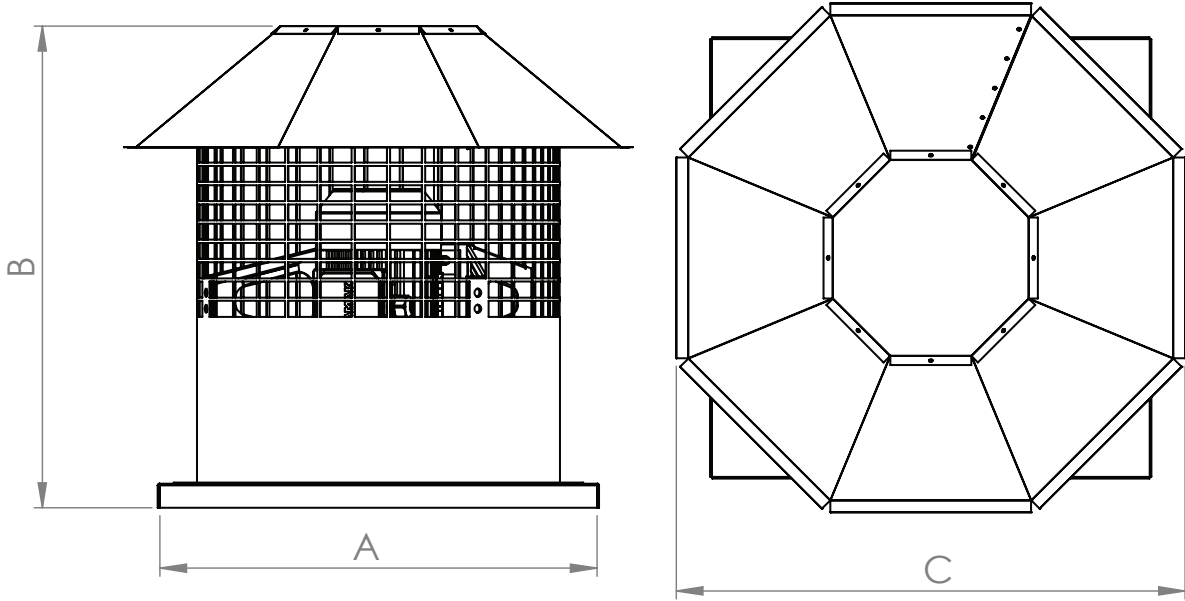

MODEL	A (mm)	B (mm)	C (mm)
CAXI 400	500	800	640
CAXI 450	550	800	640
CAXI 500	600	800	700
CAXI 560	650	800	760
CAXI 630	750	850	850
CAXI 710	850	850	950
CAXI 800	950	850	1070
CAXI 900	1050	1200	1140
CAXI 1000	1150	1200	1240
CAXI 1120	1250	1550	1390

PERFORMANS EĞRİLERİ

CAXI 400-5-25

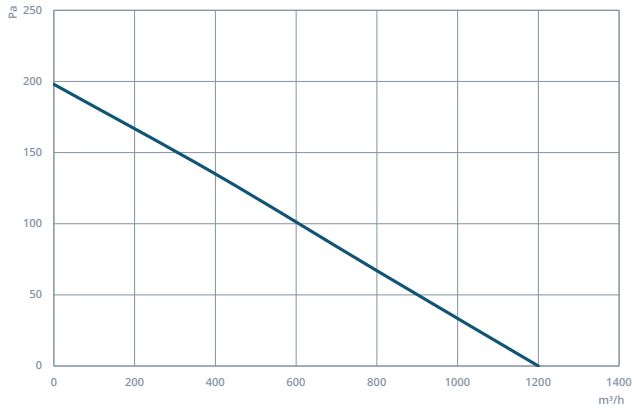

CAXI 450-5-25

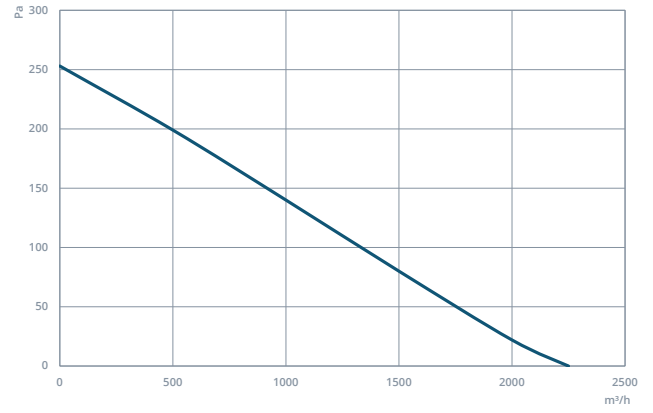

CAXI 500-5-25

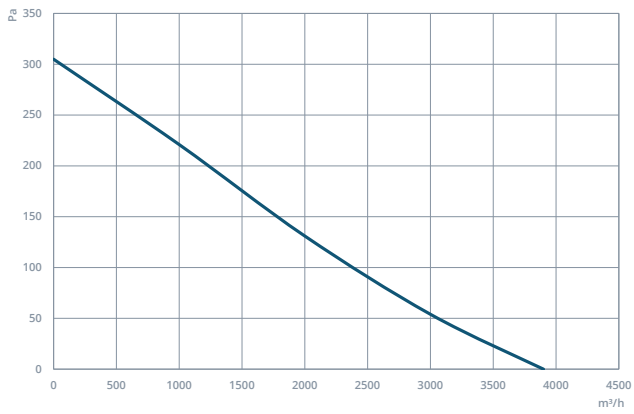

CAXI 560-5-25

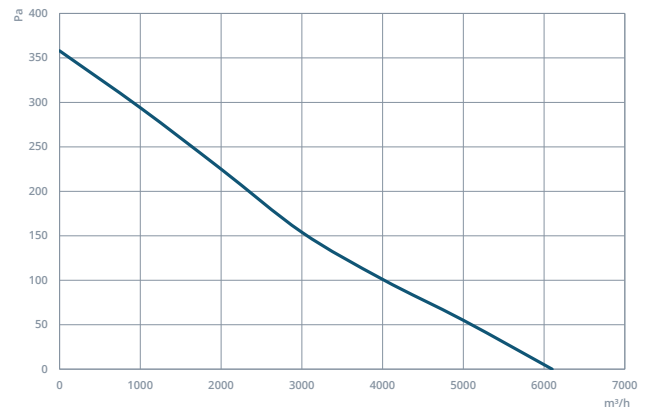

CAXI 630-5-30

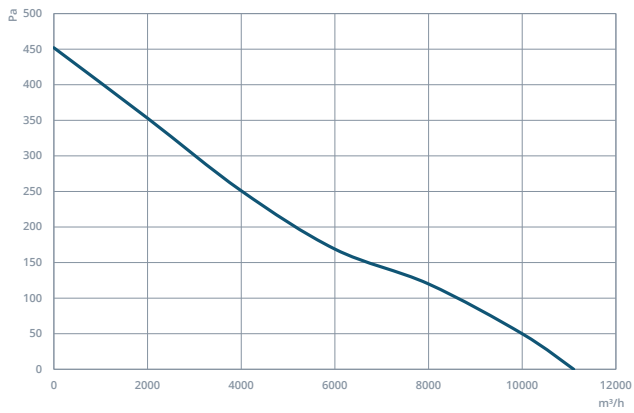

CAXI 710-5-30

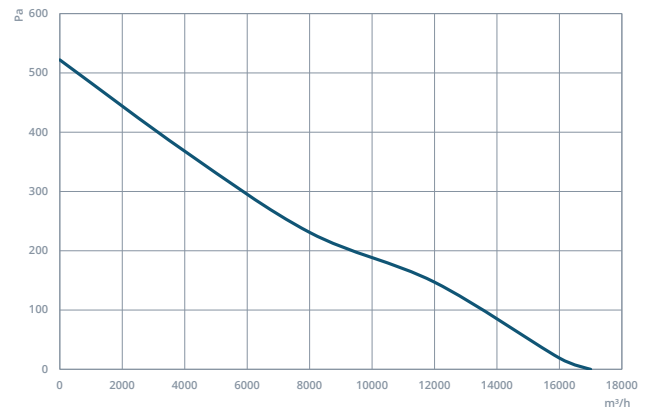

CAXI 800-5-30

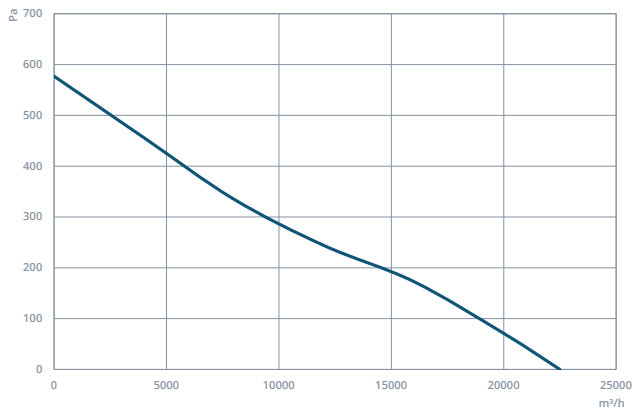

CAXI 800-5-35

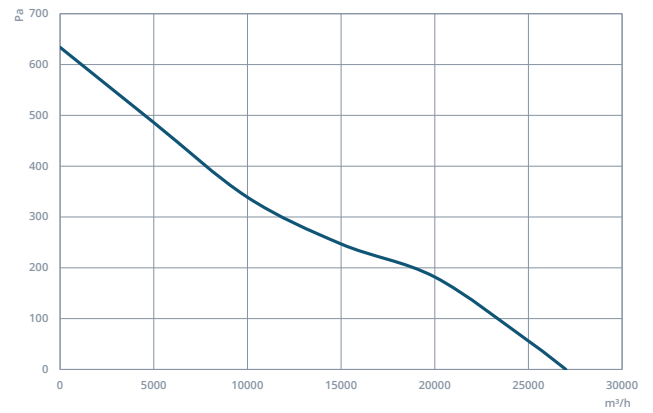

PERFORMANS EĞRİLERİ

CAXI 900-5-35

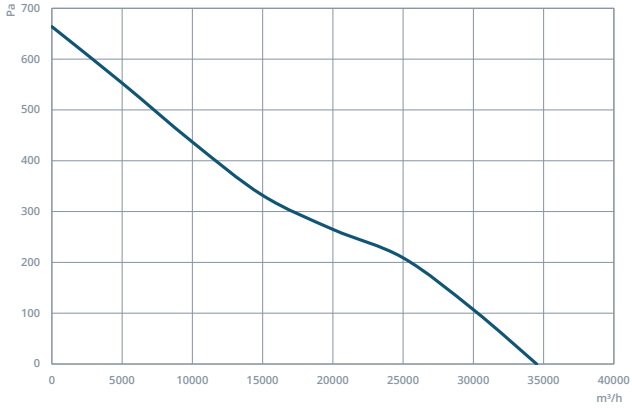

CAXI 900-5-40

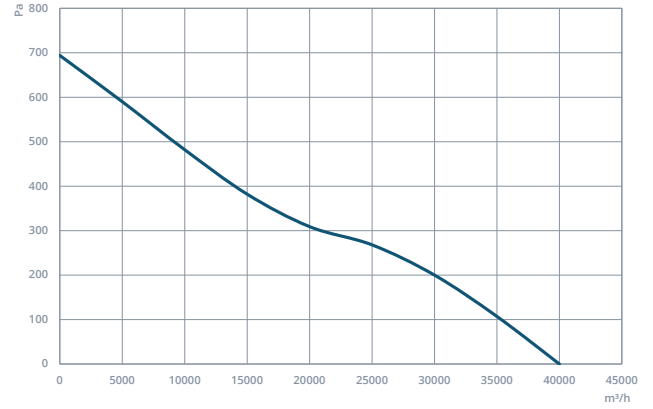

CAXI 1000-5-40

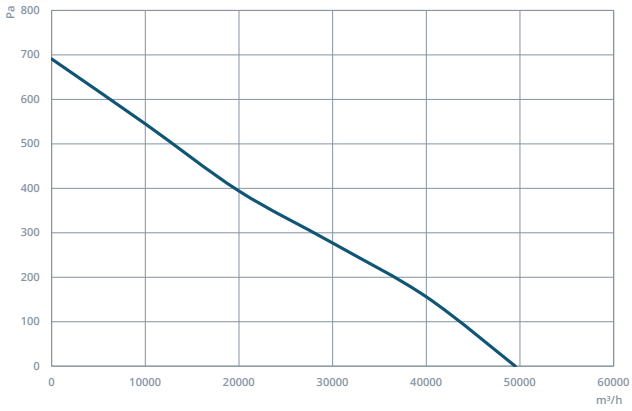

CAXI 900-8-40

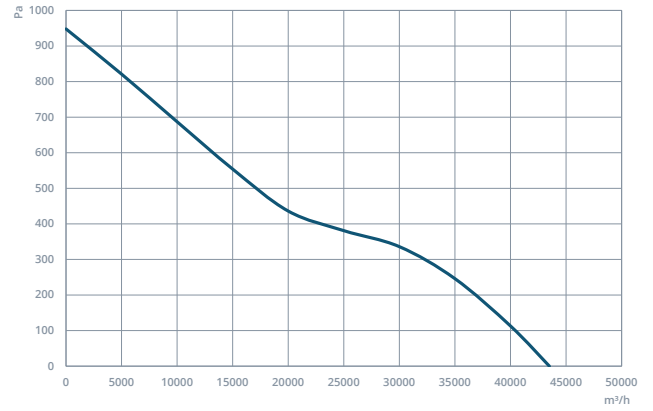

CAXI 1000-8-40

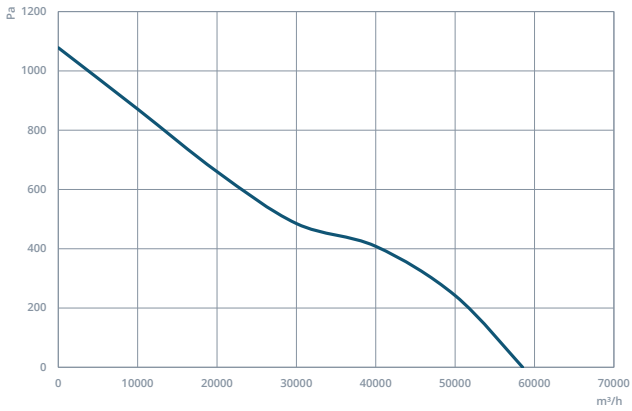

CAXI 1000-8-45

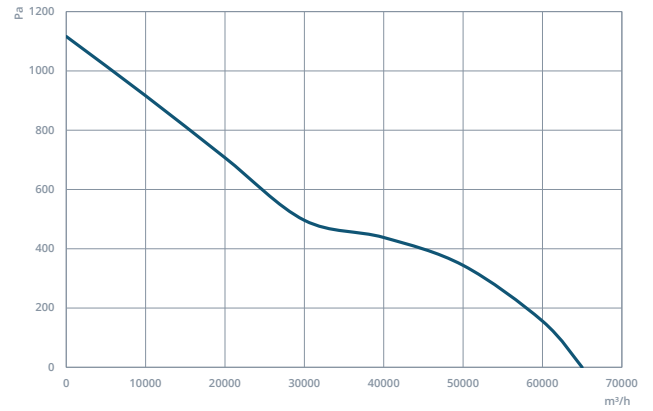

CAXI 1120-8-40

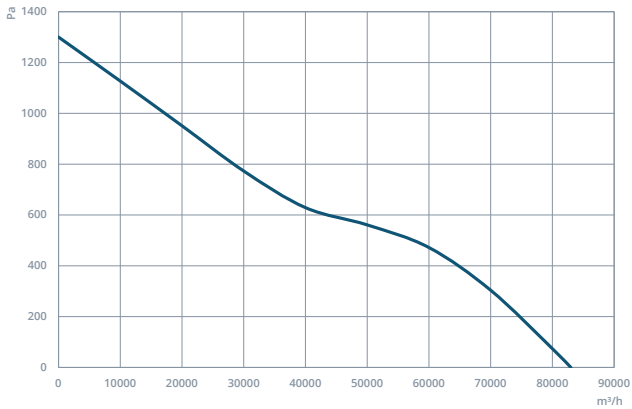

CAXI 1120-8-45

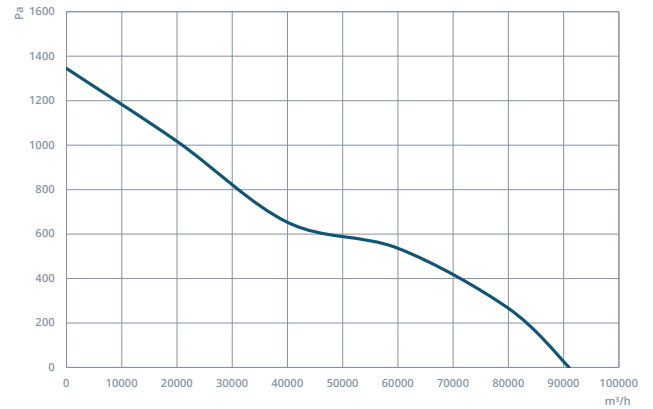

► CTAXI - Çatı Tipi Aksiyel Duman Egzoz Fanı - F300

Çatı Tipi Aksiyel Duman Egzoz fanları 300 °C sıcaklığı iki saat boyunca dayanarak, Jet Fan'lar ile beraber otoparklarda yangın durumunda dumanın tahliyesini sağlamak için kullanılabilir.



MOTOR YALITIM SINIFI	H SINIFI
MOTOR KORUMA SINIFI	IP 54-IP 55
MOTOR VERİM SINIFI	IE1-IE2
MOTOR TİPİ	TEAO
MOTOR MARKASI	-
GÖVDE MALZEMESİ	GALVANİZE SAC
GÖVDE KAPLAMASI	ELEKTRO-STATİK TOZ BOYA
PERVANE MALZEMESİ	ALÜMİNYUM
GÖREV DÖNGÜSÜ	IEC Duty Cycle-S1
ÇALIŞMA SICAKLIĞI	-20 - +50 °C
STANDARTLAR	IEC-60335-2-80, ISO 1940-1



MODEL	VOLTAJ (V)	FREKANS (Hz)	GÜÇ (kW)	DEVİR (d/dk)	DEBİ (m³/h)	SES SEVİYESİ (dB(A))	FİYAT (€/Adet)
CTAXI 450-5-25	380	50	0,55	1.456	2.200	69	1.008,00 €
CTAXI 500-5-25	380	50	0,55	1.453	3.950	72	1.039,00 €
CTAXI 560-5-25	380	50	0,75	1.466	6.100	75	1.193,00 €
CTAXI 630-5-30	380	50	1,10	1.465	11.000	80	1.343,00 €
CTAXI 710-5-30	380	50	1,50	1.472	17.000	83	1.675,00 €
CTAXI 800-5-30	380	50	2,20	1.459	22.250	85	2.148,00 €
CTAXI 800-5-35	380	50	3,00	1.463	26.940	89	2.369,00 €
CTAXI 900-5-35	380	50	4,00	1.471	34.150	90	2.777,00 €
CTAXI 900-5-40	380	50	5,50	1.472	40.000	93	3.210,00 €
CTAXI 1000-5-40	380	50	7,50	1.478	49.570	94	3.974,00 €
CTAXI 900-8-40	380	50	11,00	1.454	43.200	94	4.993,00 €
CTAXI 1000-8-40	380	50	15,00	1.456	58.850	97	5.765,00 €
CTAXI 1000-8-45	380	50	18,50	1.458	66.070	99	7.708,00 €
CTAXI 1120-8-40	380	50	22,00	1.471	84.620	100	8.905,00 €
CTAXI 1120-8-45	380	50	30,00	1.474	92.270	102	10.725,00 €

Değerler 0 Pa içindir

OPSİYONLAR



DAMPER

ÖLÇÜ	FİYAT
450	139,00 €
500	168,00 €
560	198,00 €
630	260,00 €
710	337,00 €
800	417,00 €
900	509,00 €
1000	614,00 €
1120	723,00 €

DIĞER OPSİYONLAR

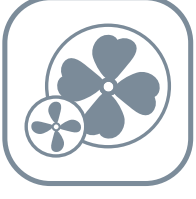

İstenilen Debi ve Basınca Özel Üretim

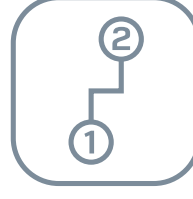

Çift Devirli Motor Seçeneđi



5, 8, 12 ve 16 Kanat Adedi Seçenekleri



Sistem Otomasyonu

TEKNİK RESİM

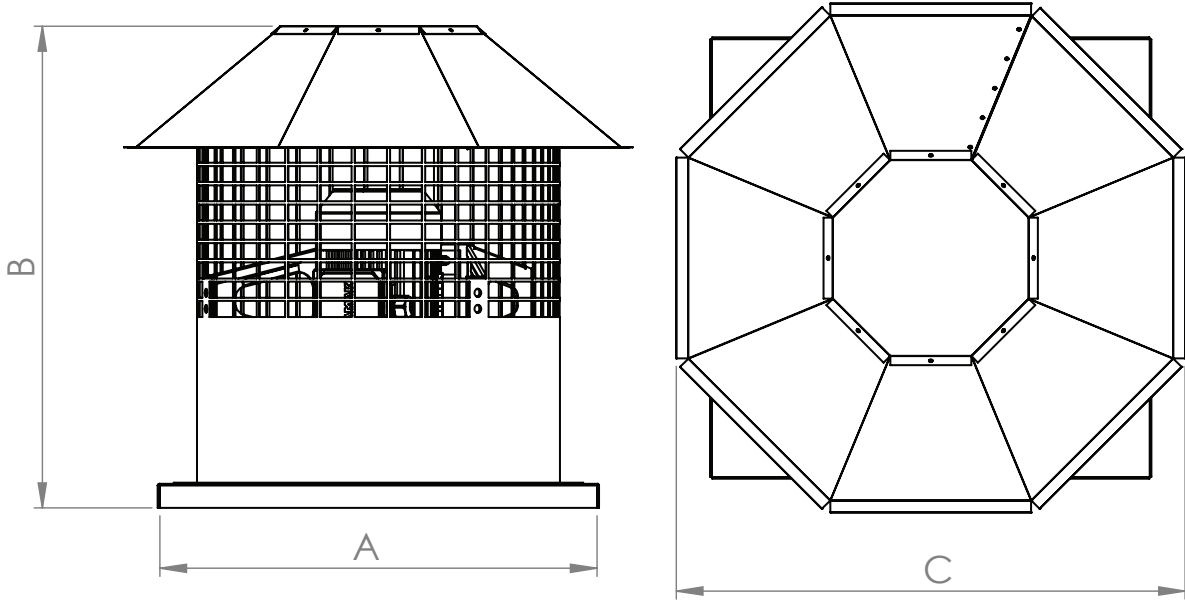

MODEL	A (mm)	B (mm)	C (mm)
CTAXI 450	550	800	640
CTAXI 500	600	800	700
CTAXI 560	650	800	760
CTAXI 630	750	850	850
CTAXI 710	850	850	950
CTAXI 800	950	850	1070
CTAXI 900	1050	1200	1140
CTAXI 1000	1150	1200	1240
CTAXI 1120	1250	1550	1390

PERFORMANS EĞRİLERİ

CTAXI 450-5-25

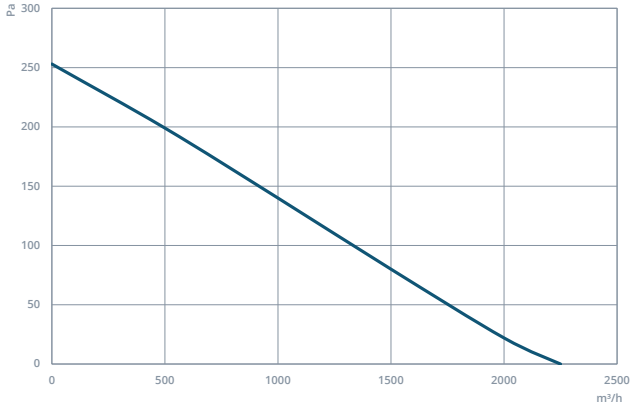

CTAXI 500-5-25

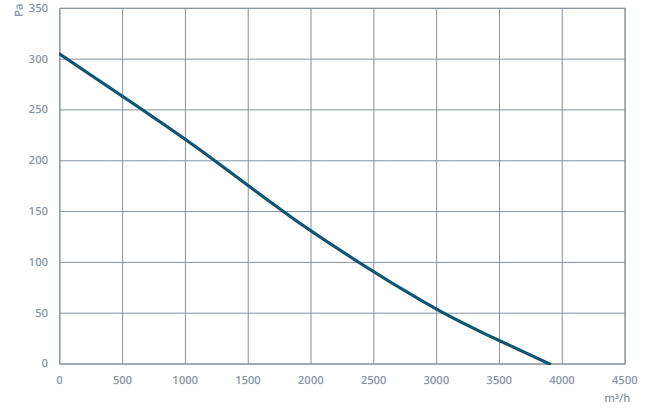

CTAXI 560-5-25

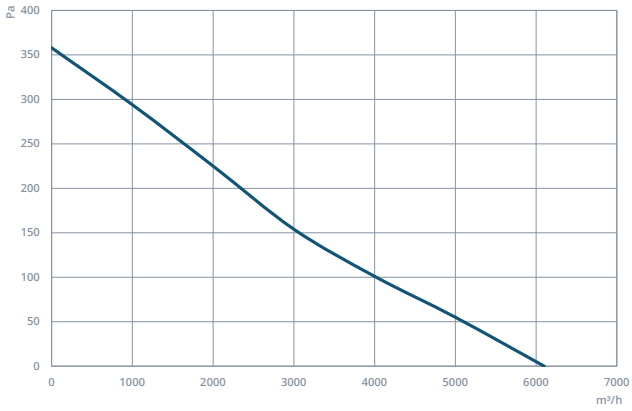

CTAXI 630-5-30

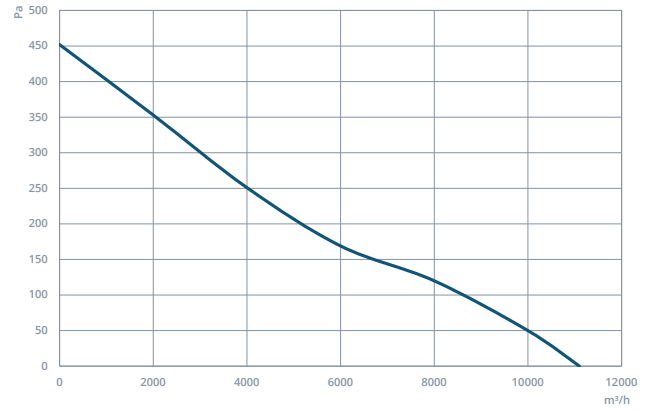

CTAXI 710-5-30

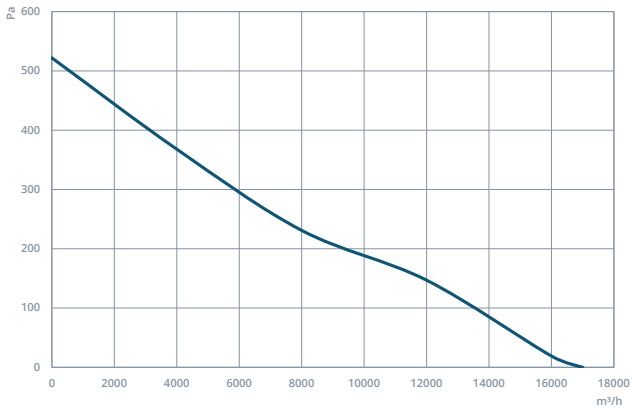

CTAXI 800-5-30

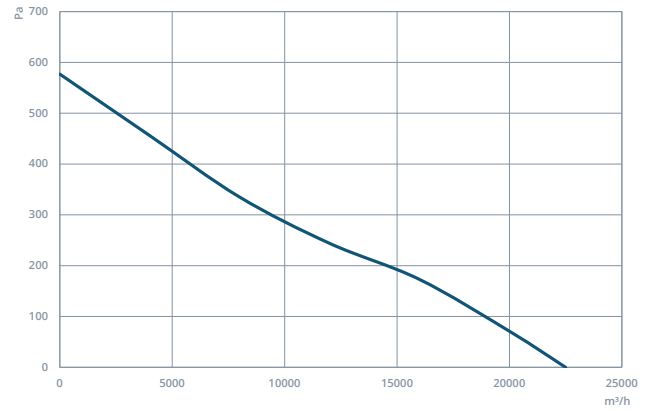

CTAXI 800-5-35

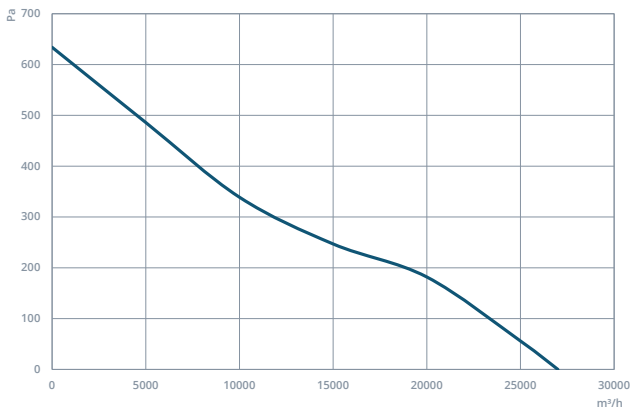

CTAXI 900-5-35

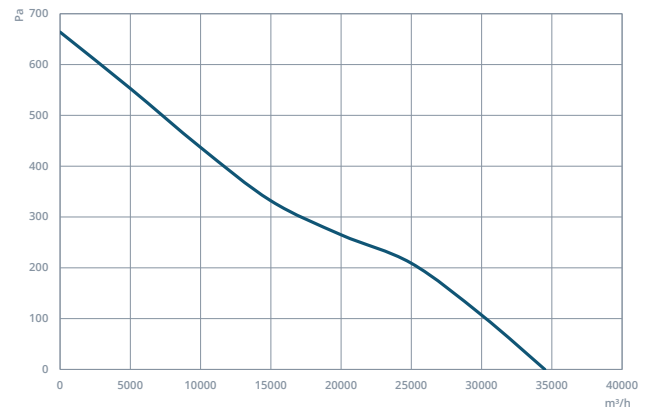

PERFORMANS EĞRİLERİ

CTAXI 900-5-40

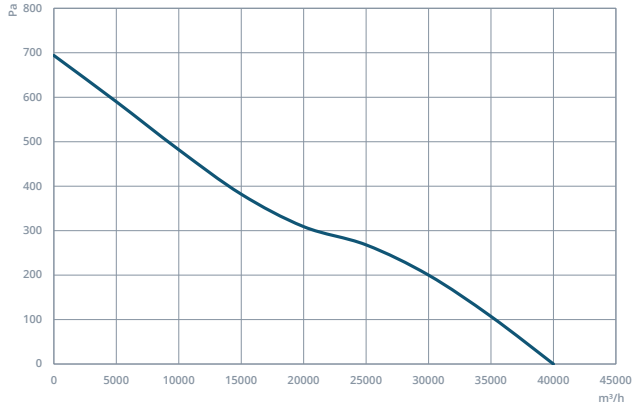

CTAXI 1000-5-40

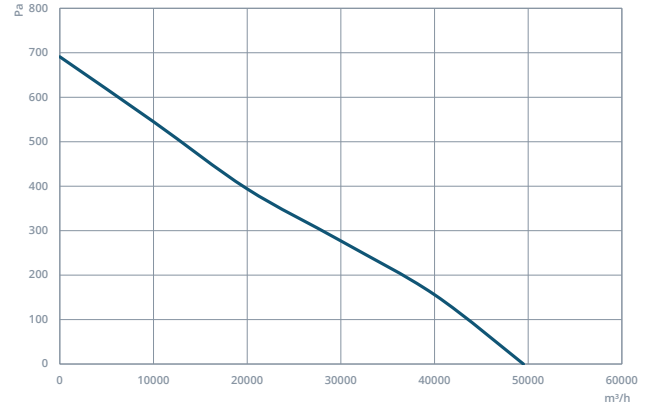

CTAXI 900-8-40

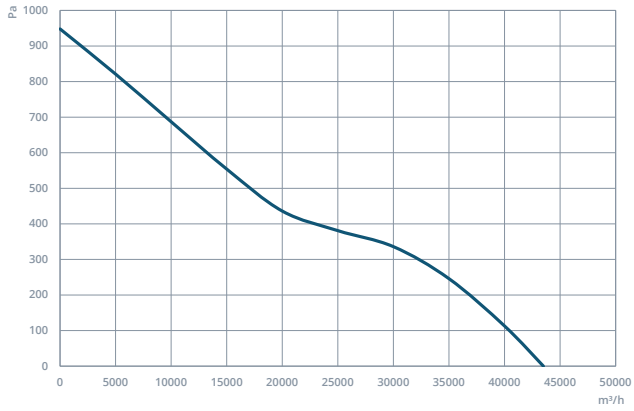

CTAXI 1000-8-40

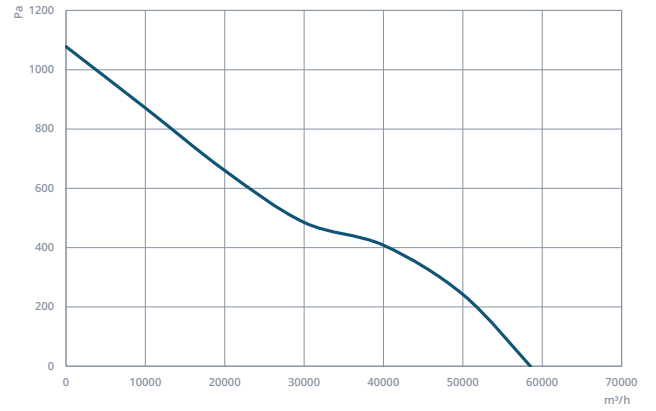

CTAXI 1000-8-45

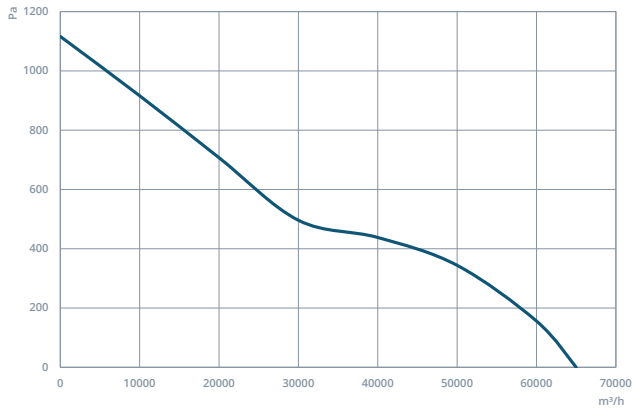

CTAXI 1120-8-40

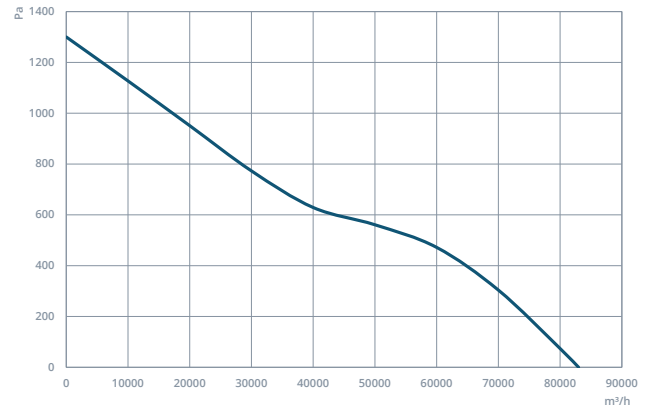

CTAXI 1120-8-45

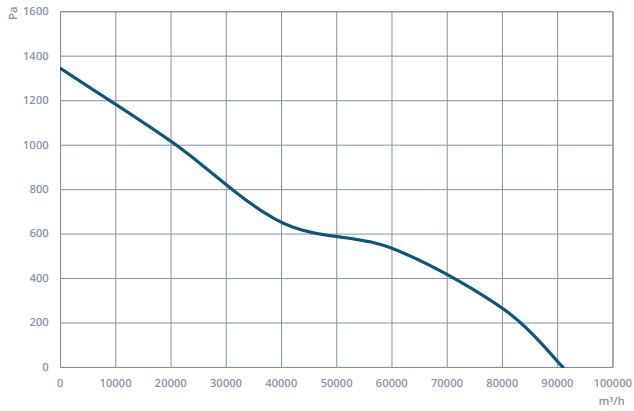

► CTAXI - Çatı Tipi Aksiyel Duman Egzoz Fanı - F400

Çatı Aksiyel Duman Egzoz fanları 400 °C sıcaklığı iki saat boyunca dayanarak, Jet Fan'lar ile beraber otoparklarda yangın durumunda dumanın tahliyesini sağlamak için kullanılabilir.



MOTOR YALITIM SINIFI	H SINIFI
MOTOR KORUMA SINIFI	IP 54-IP 55
MOTOR VERİM SINIFI	IE1-IE2
MOTOR TİPİ	TEAO
MOTOR MARKASI	-
GÖVDE MALZEMESİ	GALVANİZE SAC
GÖVDE KAPLAMASI	ELEKTRO-STATİK TOZ BOYA
PERVANE MALZEMESİ	ALÜMİNYUM
GÖREV DÖNGÜSÜ	IEC Duty Cycle-S1
ÇALIŞMA SICAKLIĞI	-20 - +50 °C
STANDARTLAR	IEC-60335-2-80, ISO 1940-1

MODEL	VOLTAJ (V)	FREKANS (Hz)	GÜÇ (kW)	DEVİR (d/dk)	DEBİ (m³/h)	SES SEVİYESİ (dB(A))	FİYAT (€/Adet)
CTAXI 450-5-25	380	50	0,55	1.456	2.200	69	1.666,00 €
CTAXI 500-5-25	380	50	0,55	1.453	3.950	72	1.688,00 €
CTAXI 560-5-25	380	50	0,75	1.466	6.100	75	1.833,00 €
CTAXI 630-5-30	380	50	1,10	1.465	11.000	80	2.065,00 €
CTAXI 710-5-30	380	50	1,50	1.472	17.000	83	2.483,00 €
CTAXI 800-5-30	380	50	2,20	1.459	22.250	85	3.116,00 €
CTAXI 800-5-35	380	50	3,00	1.463	26.940	89	3.587,00 €
CTAXI 900-5-35	380	50	4,00	1.471	34.150	90	3.807,00 €
CTAXI 900-5-40	380	50	5,50	1.472	40.000	93	4.462,00 €
CTAXI 1000-5-40	380	50	7,50	1.478	49.570	94	5.390,00 €
CTAXI 900-8-40	380	50	11,00	1.454	43.200	94	7.849,00 €
CTAXI 1000-8-40	380	50	15,00	1.456	58.850	97	9.222,00 €
CTAXI 1000-8-45	380	50	18,50	1.458	66.070	99	11.890,00 €
CTAXI 1120-8-40	380	50	22,00	1.471	84.620	100	13.500,00 €
CTAXI 1120-8-45	380	50	30,00	1.474	92.270	102	16.500,00 €

Değerler 0 Pa içindir

OPSİYONLAR



DAMPER	
ÖLÇÜ	FİYAT
450	139,00 €
500	168,00 €
560	198,00 €
630	260,00 €
710	337,00 €
800	417,00 €
900	509,00 €
1000	614,00 €
1120	723,00 €

DIĞER OPSİYONLAR



İstenilen Debi ve Basınca Özel Üretim

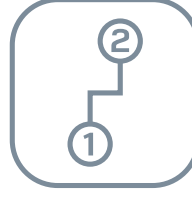

Çift Devirli Motor Seçeneđi



5, 8, 12 ve 16 Kanat Adedi Seçenekleri



Sistem Otomasyonu

TEKNİK RESİM

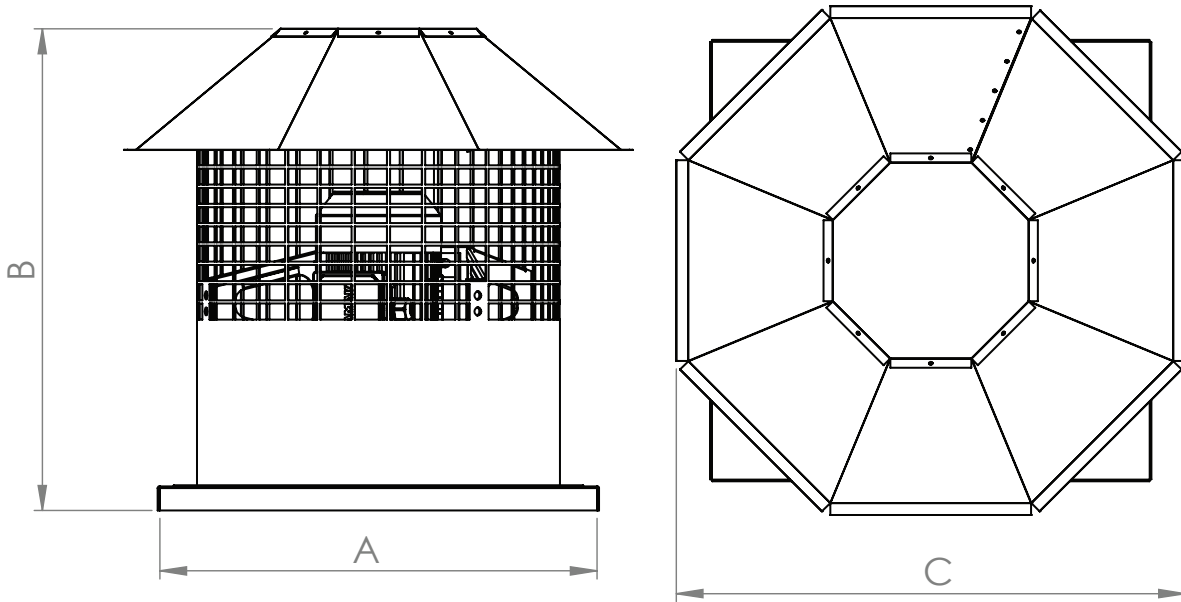

MODEL	A (mm)	B (mm)	C (mm)
CTAXI 450	550	800	640
CTAXI 500	600	800	700
CTAXI 560	650	800	760
CTAXI 630	750	850	850
CTAXI 710	850	850	950
CTAXI 800	950	850	1070
CTAXI 900	1050	1200	1140
CTAXI 1000	1150	1200	1240
CTAXI 1120	1250	1550	1390

PERFORMANS EĞRİLERİ

CTAXI 450-5-25

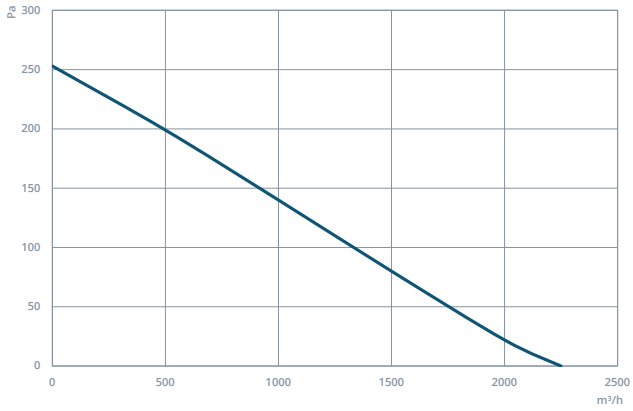

CTAXI 500-5-25

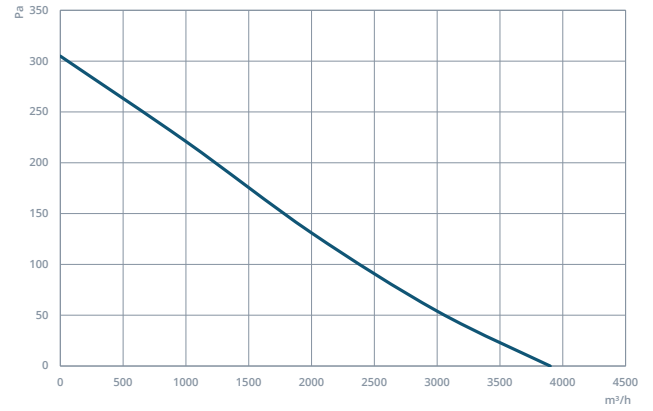

CTAXI 560-5-25

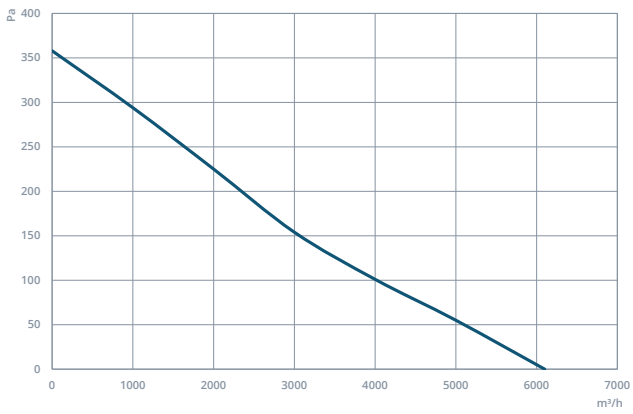

CTAXI 630-5-30

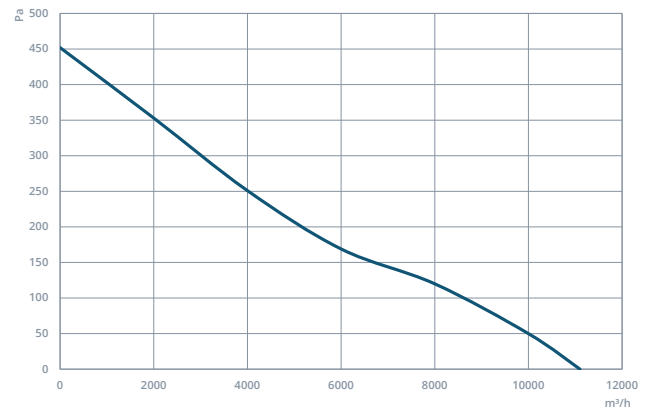

CTAXI 710-5-30

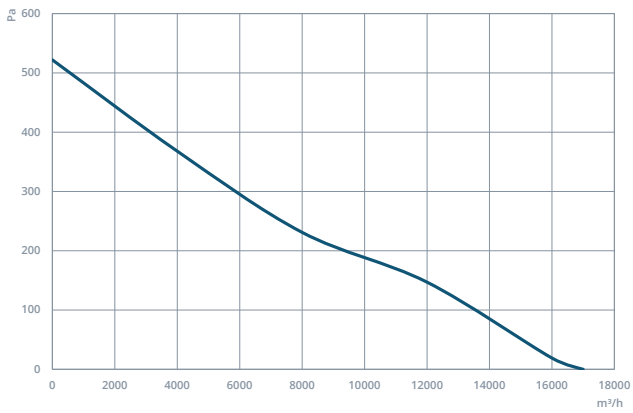

CTAXI 800-5-30

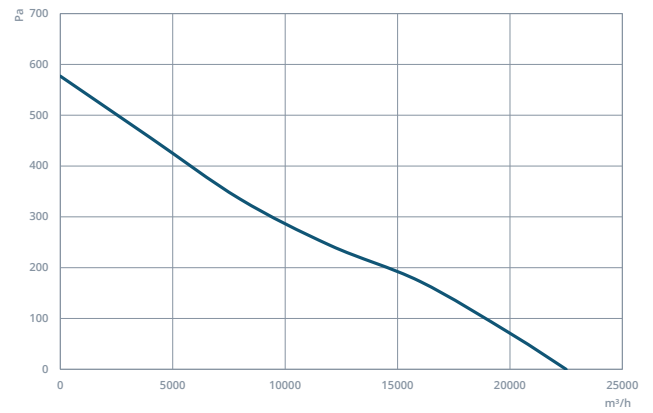

CTAXI 800-5-35

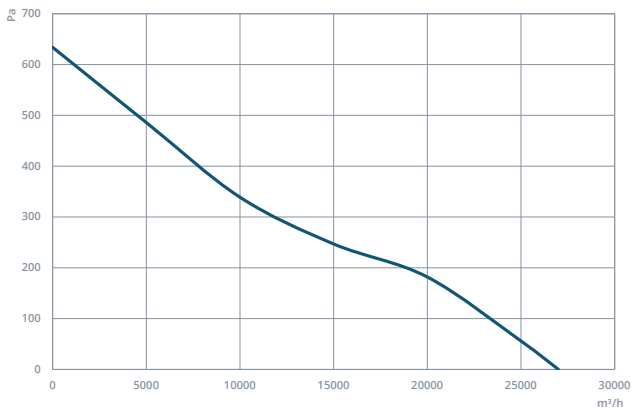

CTAXI 900-5-35

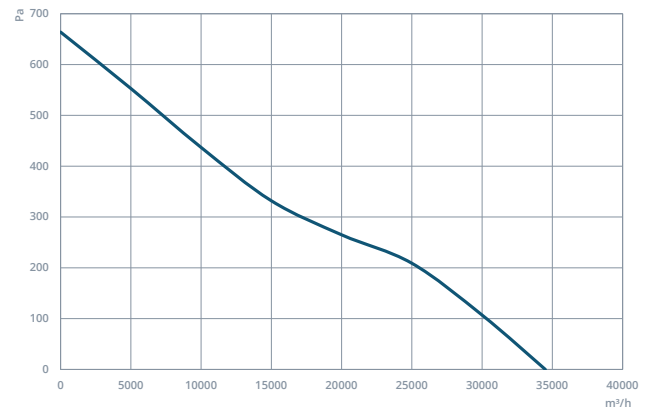

PERFORMANS EĞRİLERİ

CTAXI 900-5-40

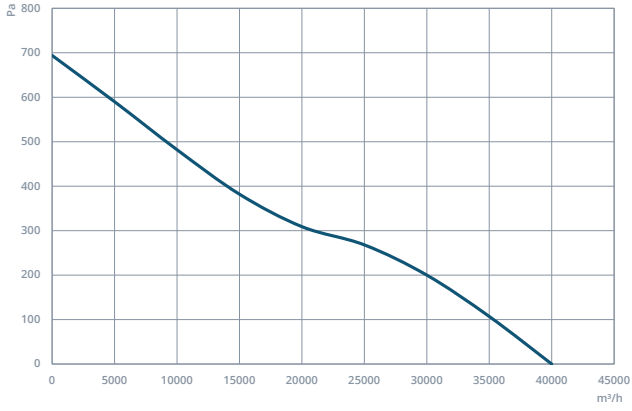

CTAXI 1000-5-40

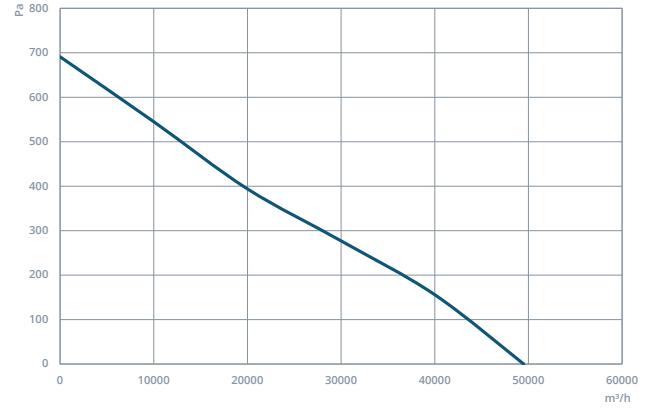

CTAXI 900-8-40

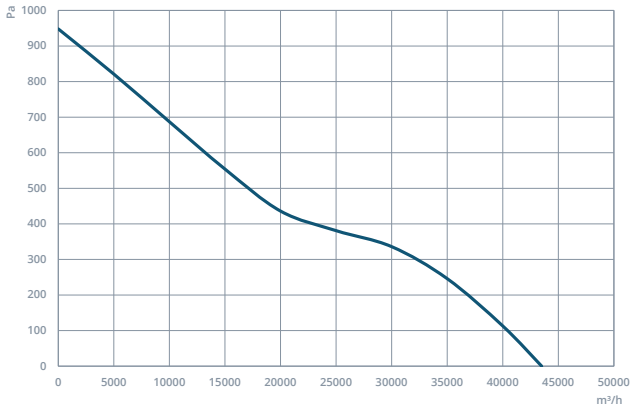

CTAXI 1000-8-40

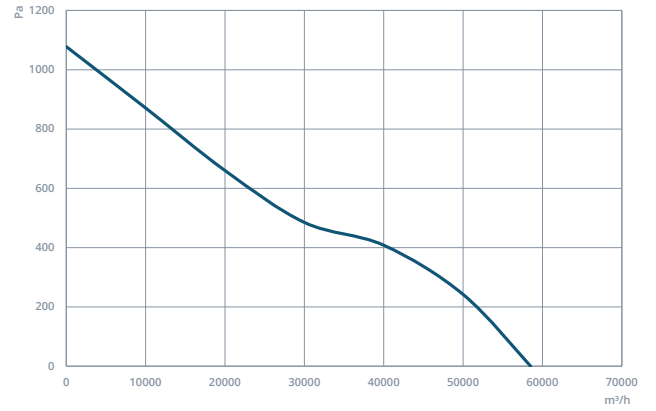

CTAXI 1000-8-45

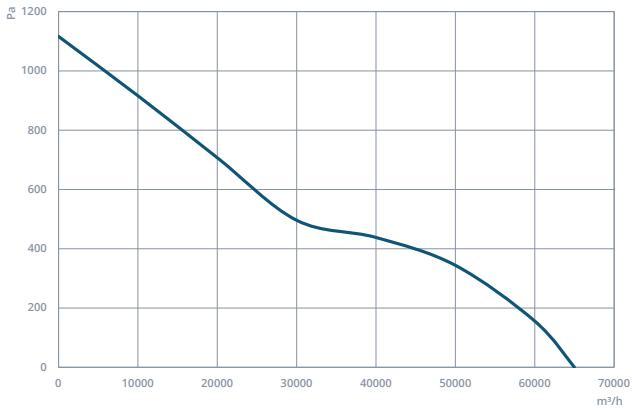

CTAXI 1120-8-40

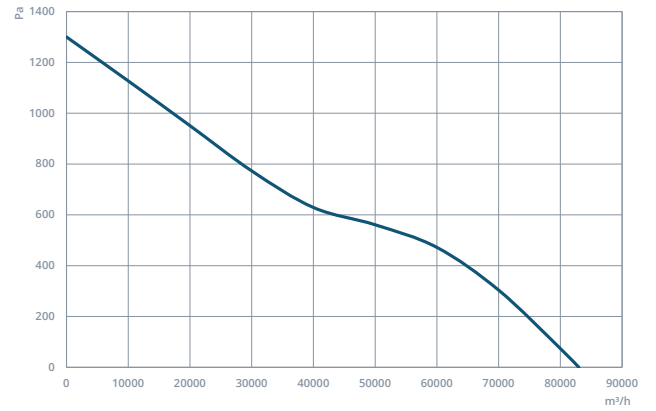

CTAXI 1120-8-45

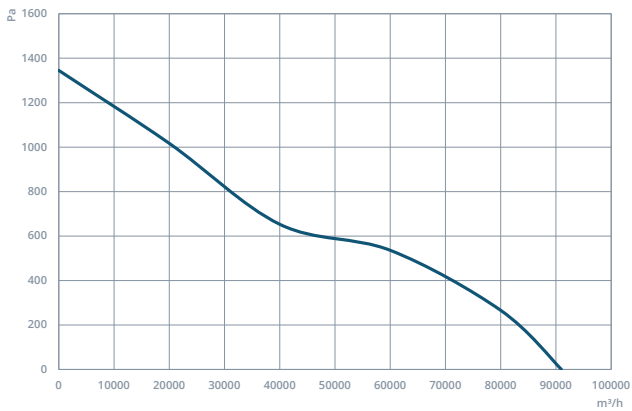

► CAXIDIK - Çatı Tipi Dik Atışlı Aksiyel Fan

CAXIDIK fanlar havayı geleneksel çatı tipi fanların aksine yatay olarak değil dikey olarak atarlar. 10 metreye kadar yüksekliğe atılan hava fanın etrafının kapalı olmasından etkilenmez ve yatay olarak üflenecek havanın civarda olabilecek insanları etkilemesini önler.



MOTOR YALITIM SINIFI	F SINIFI
MOTOR KORUMA SINIFI	IP 55
MOTOR VERİM SINIFI	IE3
MOTOR TİPİ	TEFC
MOTOR MARKASI	-
GÖVDE MALZEMESİ	GALVANİZE SAC
GÖVDE KAPLAMASI	ELEKTRO-STATİK TOZ BOYA
PERVANE MALZEMESİ	ALÜMİNYUM
GÖREV DÖNGÜSÜ	IEC Duty Cycle-S1
ÇALIŞMA SICAKLIĞI	-20 - +50 °C
STANDARTLAR	IEC-60335-2-80, ISO 1940-1



MODEL	VOLTAJ (V)	FREKANS (Hz)	GÜÇ (kW)	DEVİR (d/dk)	DEBİ (m³/h)	SES SEVİYESİ (dB(A))	FİYAT (€/Adet)
CAXIDIK 400-5-25	380	50	0,37	1.450	600	66	765,00 €
CAXIDIK 450-5-25	380	50	0,55	1.456	1.450	69	823,00 €
CAXIDIK 500-5-25	380	50	0,55	1.453	2.275	72	880,00 €
CAXIDIK 560-5-25	380	50	0,75	1.466	4.500	75	1.007,00 €
CAXIDIK 630-5-30	380	50	1,10	1.465	9.665	80	1.178,00 €
CAXIDIK 710-5-30	380	50	1,50	1.472	14.500	83	1.497,00 €
CAXIDIK 800-5-30	380	50	2,20	1.459	21.000	85	1.703,00 €
CAXIDIK 800-5-35	380	50	3,00	1.463	25.000	89	1.954,00 €

Değerler 0 Pa içindir

OPSİYONLAR



DAMPER	
ÖLÇÜ	FİYAT
400	117,00 €
450	139,00 €
500	168,00 €
560	198,00 €
630	260,00 €
710	337,00 €
800	417,00 €

DIĞER OPSİYONLAR



İstenilen Renkte Elektro-Statik Toz Boya

AL
/
PA

Alüminyum veya Plastik Kanat Seçeneği

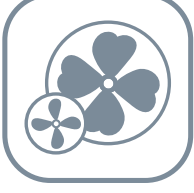

İstenilen Debi ve Basınca Özel Üretim

F300
F400

Sıcaklık Dayanımlı Motor



5, 8, 12 ve 16 Kanat Adedi Seçenekleri

2
1

Çift Devirli Motor Seçeneği

TEKNİK RESİM

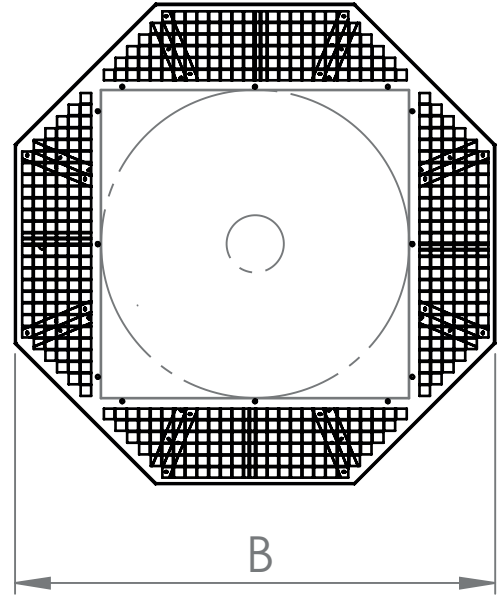
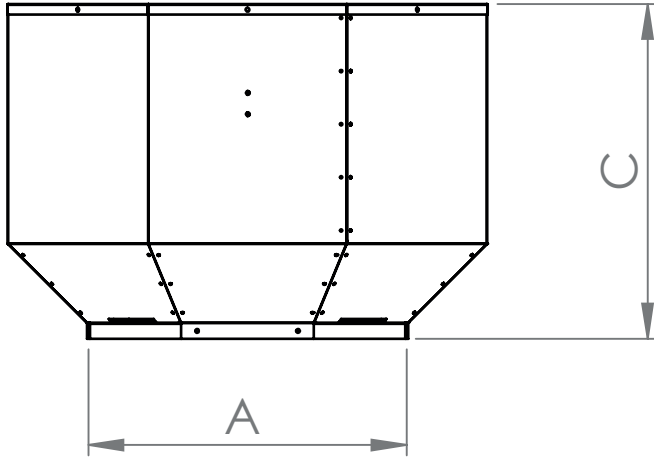

MODEL	A (mm)	B (mm)	C (mm)
CAXIDIK 400	500	800	600
CAXIDIK 450	550	850	600
CAXIDIK 500	600	900	630
CAXIDIK 560	660	960	630
CAXIDIK 630	730	1030	700
CAXIDIK 710	810	1110	700
CAXIDIK 800	900	1200	750

PERFORMANS EĞRİLERİ

CAXIDIK 400-5-25

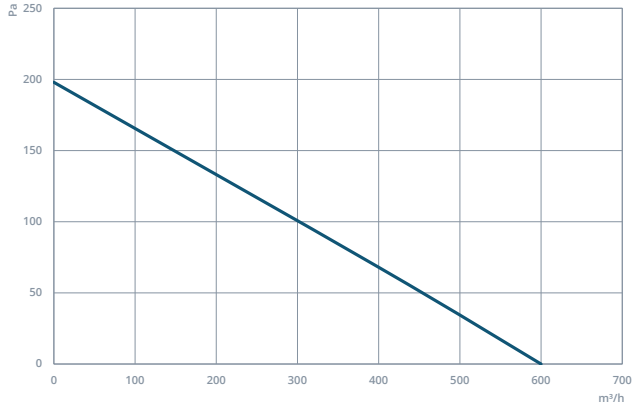

CAXIDIK 450-5-25

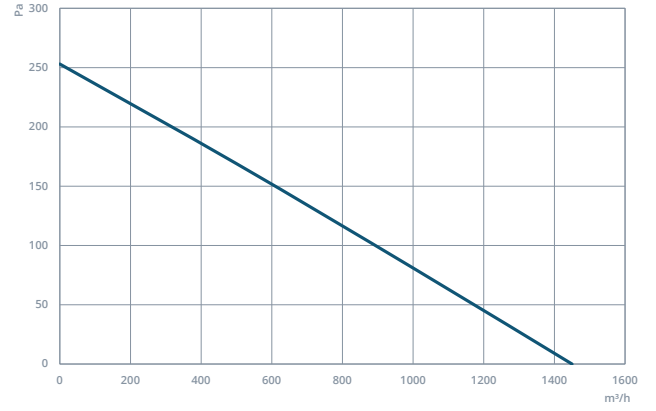

CAXIDIK 500-5-25

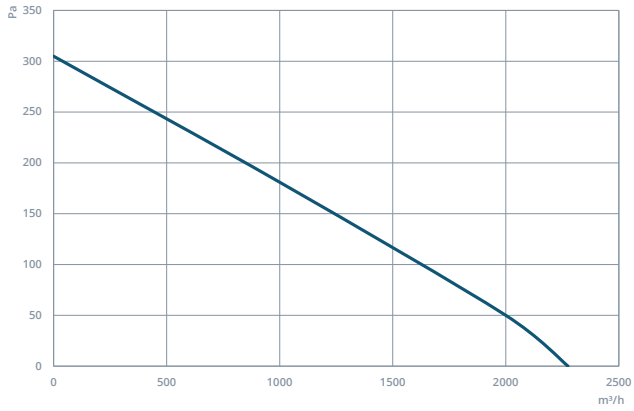

CAXIDIK 560-5-25

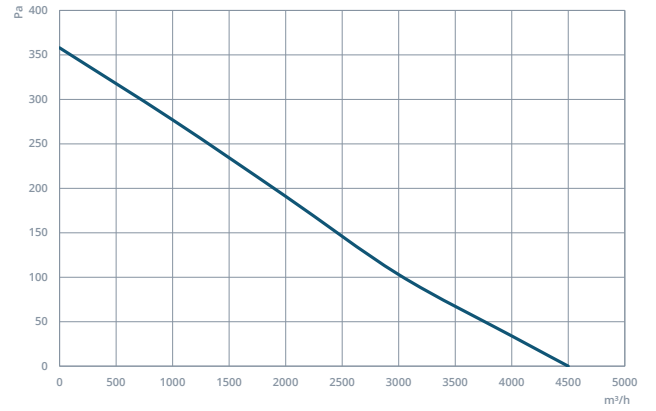

CAXIDIK 630-5-30

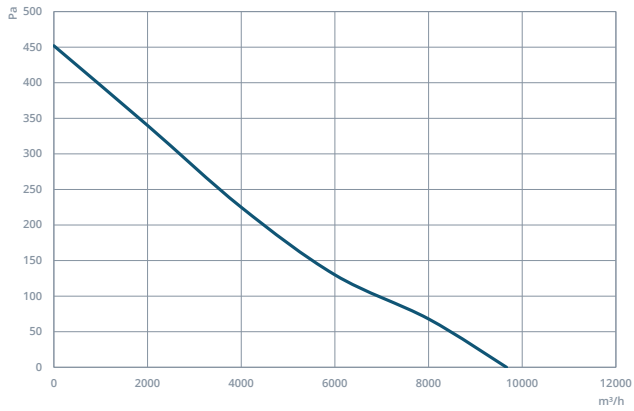

CAXIDIK 710-5-30

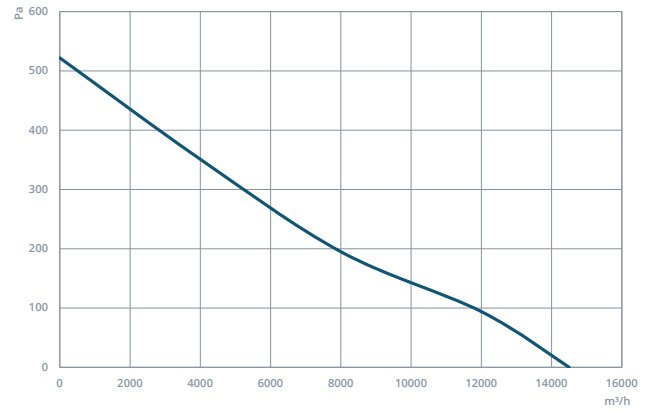

CAXIDIK 800-5-30

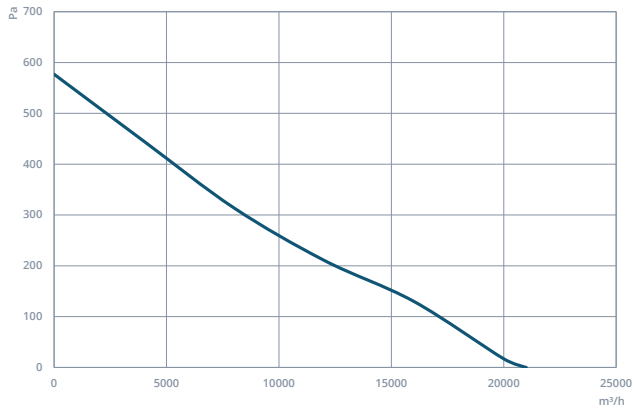

CAXIDIK 800-5-35

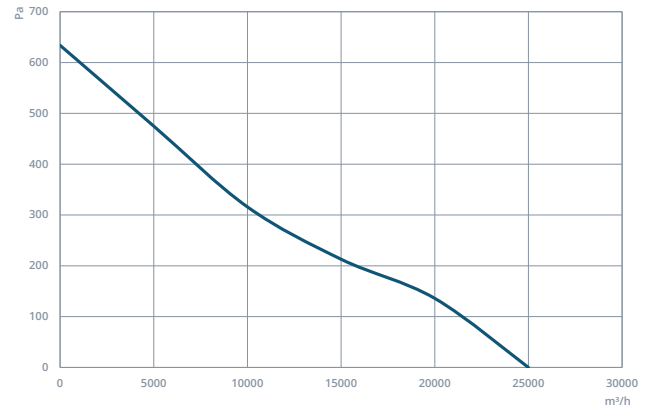

► KMF - Karıştırma Fanı

KMF fanları havanın hareket etmediği, rafların çok yoğun olduğu depo gibi alanlarda kullanılır. Ortamdaki havayı karıştırarak ve yukarıdaki sıcak havayı aşağıya indirerek dengeli bir sıcaklık dağılımı sağlamasına yardımcı olur.



MOTOR YALITIM SINIFI	F SINIFI
MOTOR KORUMA SINIFI	IP 55
MOTOR VERİM SINIFI	IE3
MOTOR TIPI	TEFC
MOTOR MARKASI	-
GOVDE MALZEMESİ	GALVANİZE SAC
GÖVDE KAPLAMASI	ELEKTRO-STATİK TOZ BOYA
PERVANE MALZEMESİ	PLASTİK
GOREV DÖNGÜSÜ	IEC Duty Cycle-S1
ÇALIŞMA SICAKLIĞI	-20 - +50 °C
STANDARTLAR	IEC-60335-2-80, ISO 1940-1

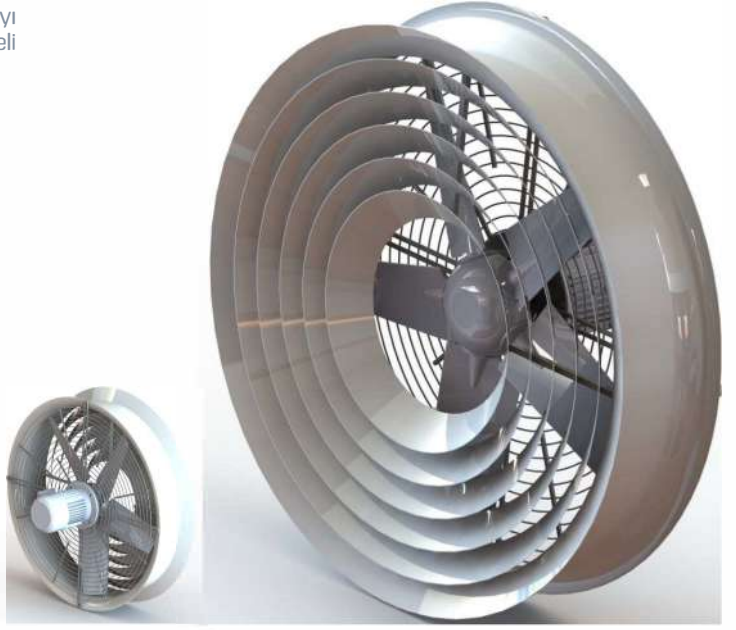

MODEL	VOLTAJ (V)	FREKANS (Hz)	GÜÇ (kW)	DEVİR (d/dk)	DEBİ (m³/h)	SES SEVİYESİ (dB(A)) (h=6m)	FIYAT (€/Adet)
KMF 800-5-30	380	50	0,25	720	13.000	66	950,00 €

TEKNİK RESİM

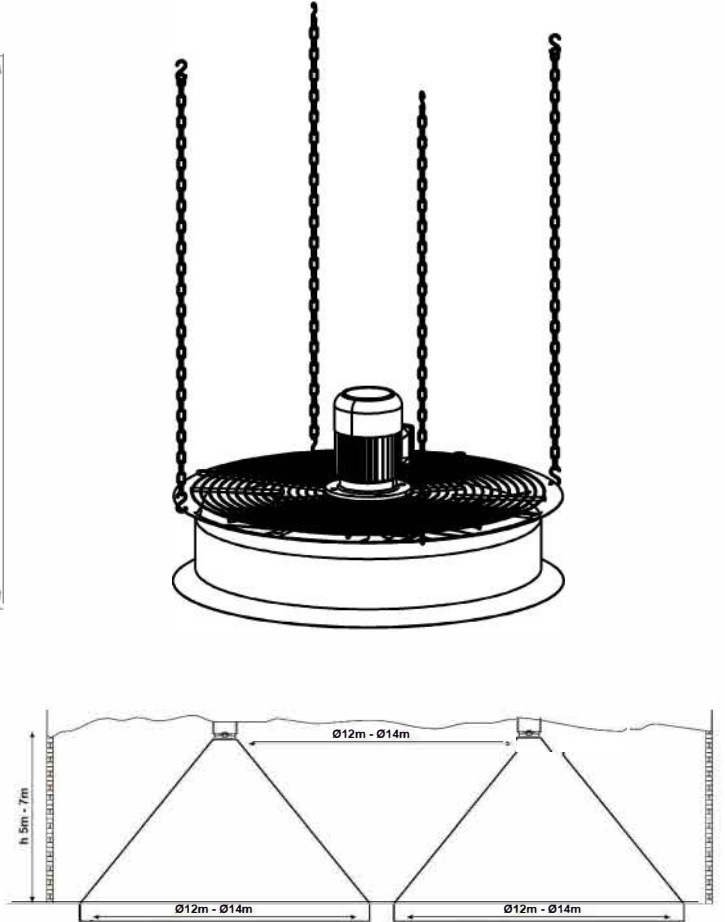
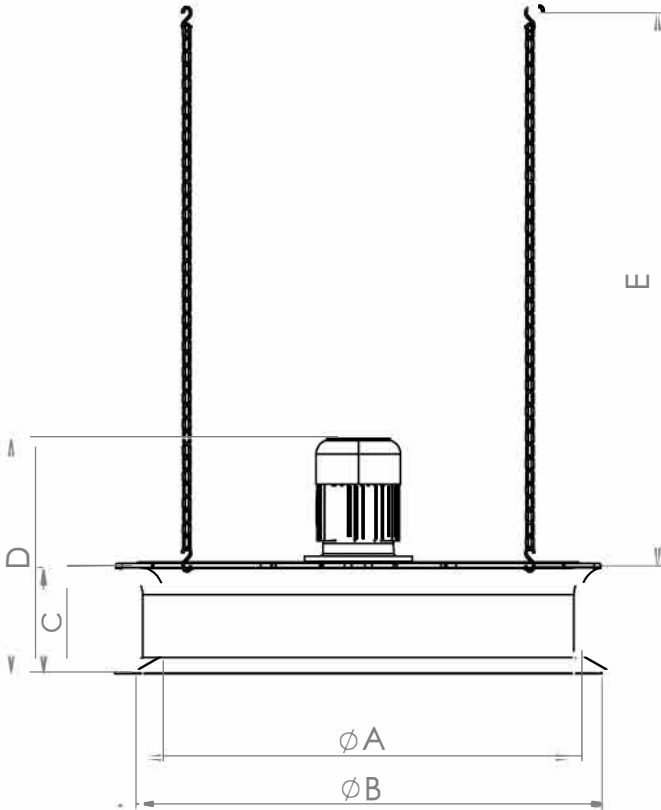

MODEL	A (mm)	B (mm)	C (mm)	D (mm)	E (mm)	Zincir Sayısı
KMF 800-5-30	800	900	200	500	1000	4

►SOF - Soğutma Fanı

Soğutma fanları ticari ve endüstriyel buzdolapları, soğuk tezgahlar ve soğuk odalarda bataryaya hava üfleme için kullanılır. İsteğe göre üfleme veya emiş şeklinde üretilebilirler.



MOTOR YALITIM SINIFI	F SINIFI
MOTOR KORUMA SINIFI	IP 44
MOTOR VERİM SINIFI	-
MOTOR TİPİ	DIŞTAN ROTORLU MOTOR
MOTOR MARKASI	-
GÖVDE MALZEMESİ	ÇELİK TEL
GÖVDE KAPLAMASI	ELEKTROSTATİK TOZ BOYA
PERVANE MALZEMESİ	ALÜMİNYUM-GALVANİZE SAC
GÖREV DÖNGÜSÜ	IEC Duty Cycle-S1
ÇALIŞMA SICAKLIĞI	-20 - +50 °C
STANDARTLAR	IEC-60335-2-80, ISO 1940-1



MODEL	VOLTAJ (V)	FREKANS (Hz)	GÜÇ (W)	DEVİR (d/dk)	DEBİ (m³/h)	SES SEVİYESİ (dB(A))	FİYAT (€/Adet)
SOF 250	220	50	50	1.380	1.000	44	70,00 \$
SOF 300	220	50	90	1.370	1.700	50	79,50 \$
SOF 350	220	50	138	1.370	2.980	58	135,00 \$
SOF 400	220	50	180	1.350	3.900	58	145,00 \$
SOF 450	220	50	250	1.380	5.100	63	170,00 \$
SOF 500	220-380	50	470	1.370	6.900	65	240,00 \$
SOF 630	220-380	50	900	1.320	12.300	69	370,00 \$

Değerler 0 Pa içindir

TEKNİK RESİM

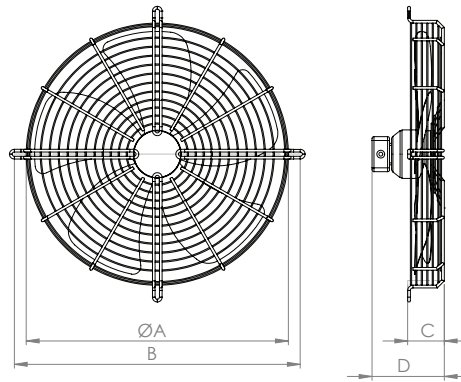

MODEL	A (mm)	B (mm)	C (mm)	D (mm)
SOF 250	250	330	80	130
SOF 300	300	380	80	130
SOF 350	350	430	80	130
SOF 400	400	480	100	150
SOF 450	450	530	100	150
SOF 500	525	565	90	170
SOF 630	680	745	95	200



K KANAL
K MONTAJ
O KULLANIM
L
A HAVA
LAN
Y DIRMA

► AXIS - Sac Kanatlı Kanal Tipi Aksiyel Fan

AXIS fanlar düşük havalandırma ihtiyacı olan ortamlarda kanala kolay montajı, düşük ses seviyesi ve güç tüketimi ile ticari ve konut havalandırma ihtiyaçlarında tercih edilebilir.



MOTOR YALITIM SINIFI	F SINIFI
MOTOR KORUMA SINIFI	IP 44
MOTOR VERİM SINIFI	-
MOTOR TİPİ	DIŞTAN ROTORLU MOTOR
MOTOR MARKASI	-
GÖVDE MALZEMESİ	GALVANİZE SAC
GÖVDE KAPLAMASI	ELEKTRO-STATİK TOZ BOYA
PERVANE MALZEMESİ	GALVANİZE SAC
GÖREV DÖNGÜSÜ	IEC Duty Cycle-S1
ÇALIŞMA SICAKLIĞI	-20 - +50 °C
STANDARTLAR	IEC-60335-2-80, ISO 1940-1



MODEL	VOLTAJ (V)	FREKANS (Hz)	GÜÇ (W)	HIZ ANAHTARI MODELİ	DEVİR (d/dk)	DEBİ (m³/h)	SES SEVİYESİ (dB(A))	FİYAT (€/Adet)
AXIS 200	230	50	70	KHA 2,5 A	2.650	680	50	60,00 €
AXIS 250	230	50	100	KHA 2,5 A	2.700	1.500	52	70,00 €
AXIS 300	230	50	163	KHA 2,5 A	2.550	2.025	54	80,00 €
AXIS 350	230	50	240	KHA 2,5 A	2.250	3.110	58	90,00 €

Değerler 0 Pa içindir
HIZ ANAHTARI CİHAZ FİYATLARINA DAHİL DEĞİLDİR.

TEKNİK RESİM

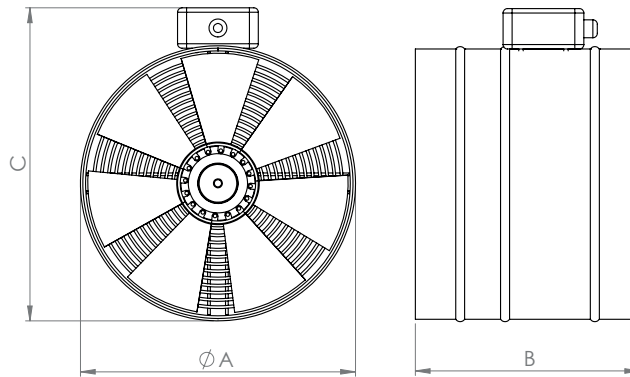

MODEL	A (mm)	B (mm)	C (mm)
AXIS 200	197	250	247
AXIS 250	247	250	297
AXIS 300	297	250	347
AXIS 350	347	350	397

K CAM
DUVAR
O MONTAJ

L
A HAVA
LAN
Y DIRMA

► DAXIS - Sac Kanatlı Duvar Tipi Aksiyel Fan

DAXIS fanlar düşük havalandırma ihtiyacı olan ortamlarda duvara veya pencereye kolay montajı, düşük ses seviyesi ve güç tüketimi ile ticari ve konut havalandırma ihtiyaçlarında tercih edilebilir.



MOTOR YALITIM SINIFI	F SINIFI
MOTOR KORUMA SINIFI	IP 44
MOTOR VERİM SINIFI	-
MOTOR TİPİ	DIŞTAN ROTORLU MOTOR
MOTOR MARKASI	-
GÖVDE MALZEMESİ	GALVANİZE SAC
GÖVDE KAPLAMASI	ELEKTROSTATİK TOZ BOYA
PERVANE MALZEMESİ	GALVANİZE SAC
GÖREV DÖNGÜSÜ	IEC Duty Cycle-S1
ÇALIŞMA SICAKLIĞI	-20 - +50 °C
STANDARTLAR	IEC-60335-2-80, ISO 1940-1



MODEL	VOLTAJ (V)	FREKANS (Hz)	GÜÇ (W)	HIZ ANAHTARI MODELİ	DEVİR (d/dk)	DEBİ (m³/h)	SES SEVİYESİ (dB(A))	FİYAT (€/Adet)
DAXIS 200	230	50	70	KHA 2,5 A	2.650	680	50	60,00 €
DAXIS 250	230	50	100	KHA 2,5 A	2.700	1.500	52	70,00 €
DAXIS 300	230	50	163	KHA 2,5 A	2.550	2.025	54	80,00 €
DAXIS 350	230	50	240	KHA 2,5 A	2.250	3.110	58	90,00 €

Değerler 0 Pa içindir
HIZ ANAHTARI CİHAZ FİYATLARINA DAHİL DEĞİLDİR.

TEKNİK RESİM

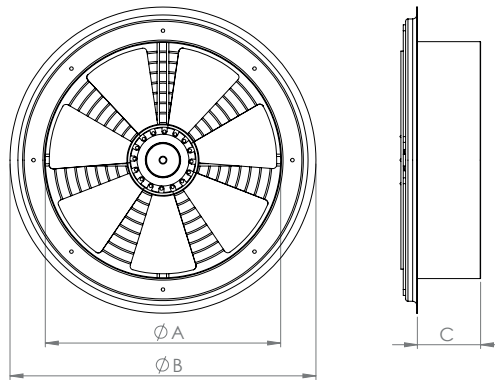

MODEL	A (mm)	B (mm)	C (mm)
DAXIS 200	197	290	70
DAXIS 250	247	340	70
DAXIS 300	297	390	80
DAXIS 350	347	440	80

K CAM
DUVAR
O MONTAJ

L
A HAVA
LAN
Y DIRMA

► KDAXIS - Kare Gövdeli Sac Kanatlı Duvar Tipi Aksiyel Fan

KDAXIS fanlar düşük havalandırma ihtiyacı olan ortamlarda duvara veya pencereye kolay montajı, düşük ses seviyesi ve güç tüketimi ile ticari ve konut havalandırma ihtiyaçlarında tercih edilebilir.



MOTOR YALITIM SINIFI	F SINIFI
MOTOR KORUMA SINIFI	IP 44
MOTOR VERİM SINIFI	-
MOTOR TİPİ	DIŞTAN ROTORLU MOTOR
MOTOR MARKASI	-
GÖVDE MALZEMESİ	GALVANİZE SAC
GÖVDE KAPLAMASI	ELEKTRO-STATİK TOZ BOYA
PERVANE MALZEMESİ	GALVANİZE SAC
GÖREV DÖNGÜSÜ	IEC Duty Cycle-S1
ÇALIŞMA SICAKLIĞI	-20 - +50 °C
STANDARTLAR	IEC-60335-2-80, ISO 1940-1



MODEL	VOLTAJ (V)	FREKANS (Hz)	GÜÇ (W)	HIZ ANAHTARI MODELİ	DEVİR (d/dk)	DEBİ (m³/h)	SES SEVİYESİ (dB(A))	FİYAT (€/Adet)
KDAXIS 200	230	50	70	KHA 2,5 A	2.650	680	50	60,00 €
KDAXIS 250	230	50	100	KHA 2,5 A	2.700	1.500	52	70,00 €
KDAXIS 300	230	50	163	KHA 2,5 A	2.550	2.025	54	80,00 €
KDAXIS 350	230	50	240	KHA 2,5 A	2.250	3.110	58	90,00 €

Değerler 0 Pa içindir
HIZ ANAHTARI CİHAZ FİYATLARINA DAHİL DEĞİLDİR.

TEKNİK RESİM

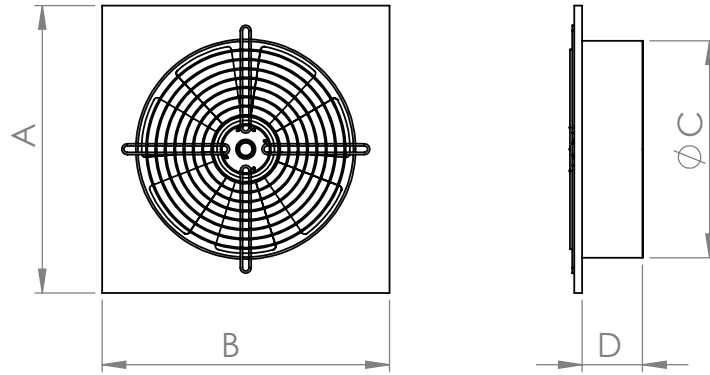

MODEL	A (mm)	B (mm)	C (mm)	D (mm)
KDAXIS 200	300	300	197	40
KDAXIS 250	350	350	247	40
KDAXIS 300	400	400	297	40
KDAXIS 350	450	450	347	40

K BAKIM
K KANAL
O MONTAJ

L

A HAVA
L AN
Y DIRMA

KAP - Karma Akışlı Plastik Fan

KAP fanlar karma akışlı pervanesi ile havalandırma sistemlerinizde kullanılabilir.



MOTOR YALITIM SINIFI	F SINIFI
MOTOR KORUMA SINIFI	IP 44
MOTOR VERİM SINIFI	-
MOTOR MARKASI	-
GÖVDE MALZEMESİ	PLASTİK
YANMAZLIK SINIFI	-
PERVANE MALZEMESİ	PLASTİK
GÖREV DÖNGÜSÜ	IEC Duty Cycle-S1
ÇALIŞMA SICAKLIĞI	-20 - +50 °C
STANDARTLAR	IEC-60335-2-80, ISO 1940-1

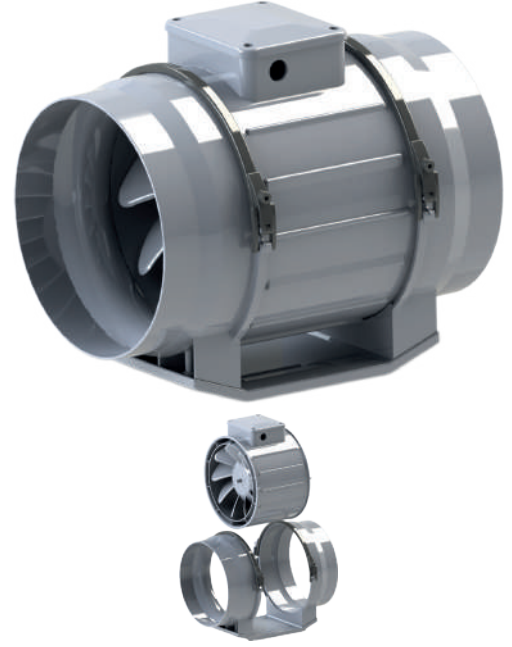

MODEL	VOLTAJ (V)	FREKANS (Hz)	GÜÇ (W)	HIZ ANAHTARI MODELİ	DEVİR (d/dk)	DEBİ (m³/h)	SES SEVİYESİ (dB(A))	FİYAT (€/Adet)
KAP 100	230	50	54	KHA 2,5 A	2.148	203	31	28,60 €
KAP 125	230	50	56	KHA 2,5 A	2.190	298	32	31,50 €
KAP 150	230	50	75	KHA 2,5 A	2.110	444	33	53,00 €
KAP 160	230	50	75	KHA 2,5 A	2.137	490	33	53,00 €

Değerler 0 Pa içindir
HIZ ANAHTARI CİHAZ FİYATLARINA DAHİL DEĞİLDİR.

TEKNİK RESİM

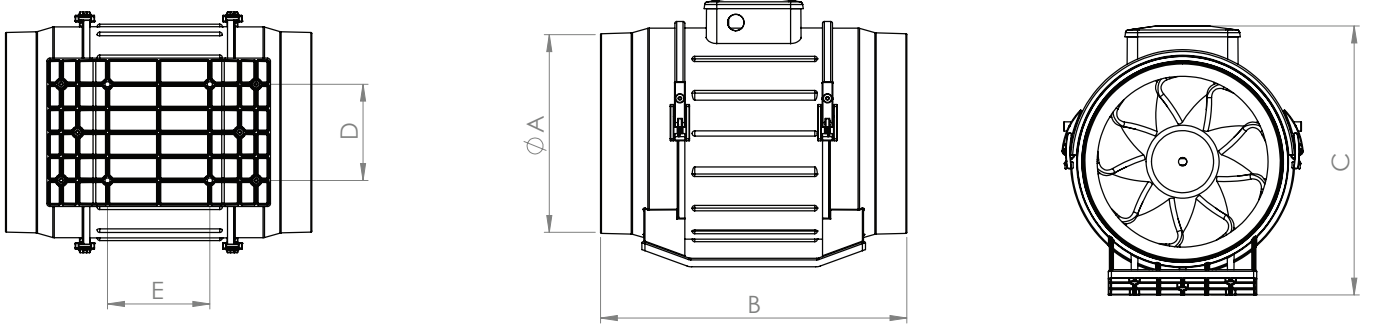

MODEL	A (mm)	B (mm)	C (mm)	D (mm)	E (mm)
KAP 100	96	306,5	215	60	80
KAP 125	121	260	215	60	80
KAP 150	146	290,5	242	60	80
KAP 160	156	271	242	60	80

PERFORMANS EĞRİLERİ

KAP 100

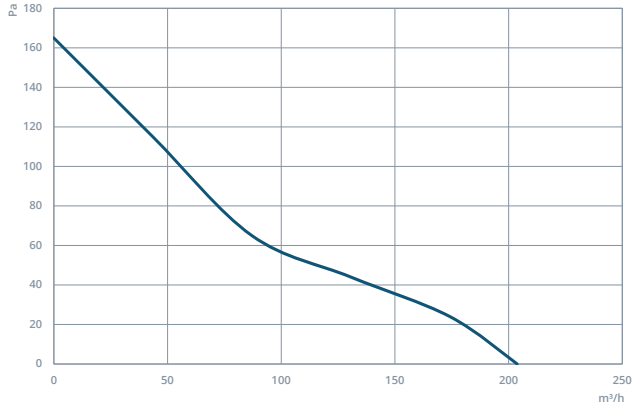

KAP 125

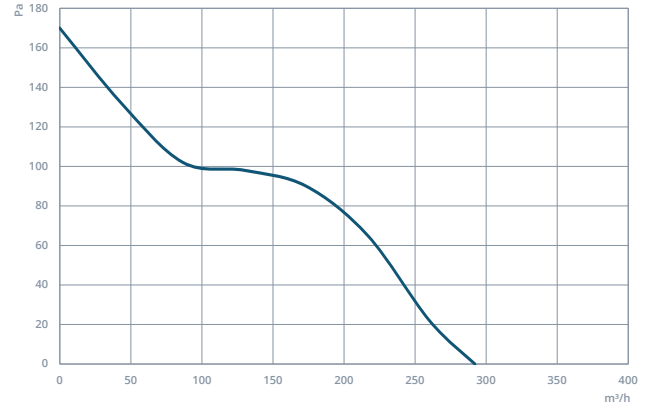

KAP 150

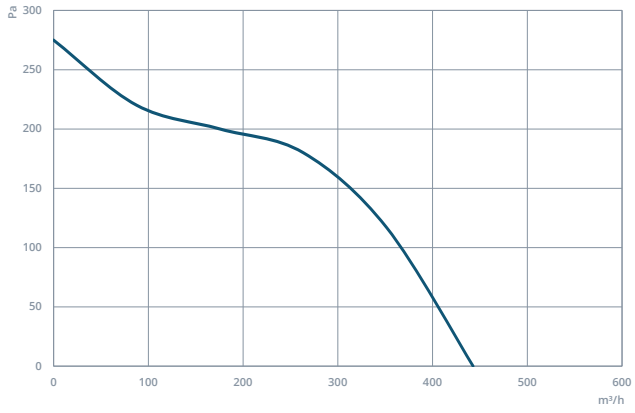

KAP 160

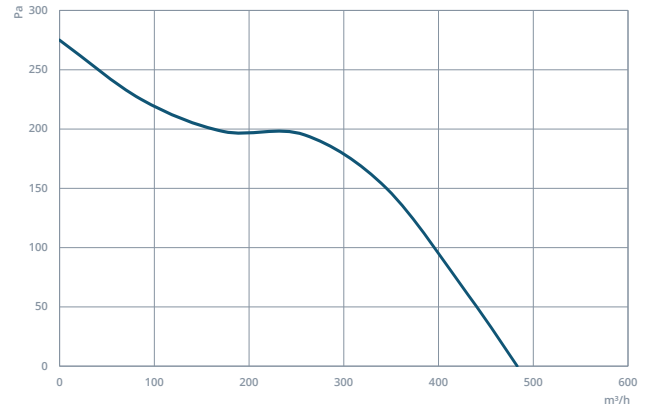

► KAF - Karma Akışlı Plastik Fan

KAF fanlar karma akışlı pervanesi ve verimli motoru ile havalandırma sistemlerinizde kullanılabilir. V0 yanmazlık sınıfında alev yürütme özelliğine sahiptir



MOTOR YALITIM SINIFI	F SINIFI
MOTOR KORUMA SINIFI	IP 44
MOTOR VERİM SINIFI	-
MOTOR MARKASI	-
GÖVDE MALZEMESİ	PLASTİK
YANMAZLIK SINIFI	V0
PERVANE MALZEMESİ	PLASTİK
GÖREV DÖNGÜSÜ	IEC Duty Cycle-S1
ÇALIŞMA SICAKLIĞI	-20 - +50 °C
STANDARTLAR	IEC-60335-2-80, ISO 1940-1



MODEL	VOLTAJ (V)	FREKANS (Hz)	GÜÇ (W)	HIZ ANAHTARI MODELİ	DEVİR (d/dk)	DEBİ (m³/h)	SES SEVİYESİ (dB(A))	FİYAT (€/Adet)
KAF 100	230	50	54	KHA 2,5 A	2.460	234	31	62,00 €
KAF 125	230	50	56	KHA 2,5 A	2.560	337	32	66,00 €
KAF 150	230	50	75	KHA 2,5 A	2.490	504	33	86,00 €
KAF 160	230	50	75	KHA 2,5 A	2.490	560	33	86,00 €
KAF 200	230	50	111	KHA 2,5 A	2.410	1.012	36	112,00 €
KAF 250	230	50	280	KHA 2,5 A	2.460	1.350	38	188,00 €
KAF 315	230	50	476	KHA 2,5 A	2.476	1.970	42	380,00 €

Değerler 0 Pa içindir

HIZ ANAHTARI CİHAZ FİYATLARINA DAHİL DEĞİLDİR.

TEKNİK RESİM

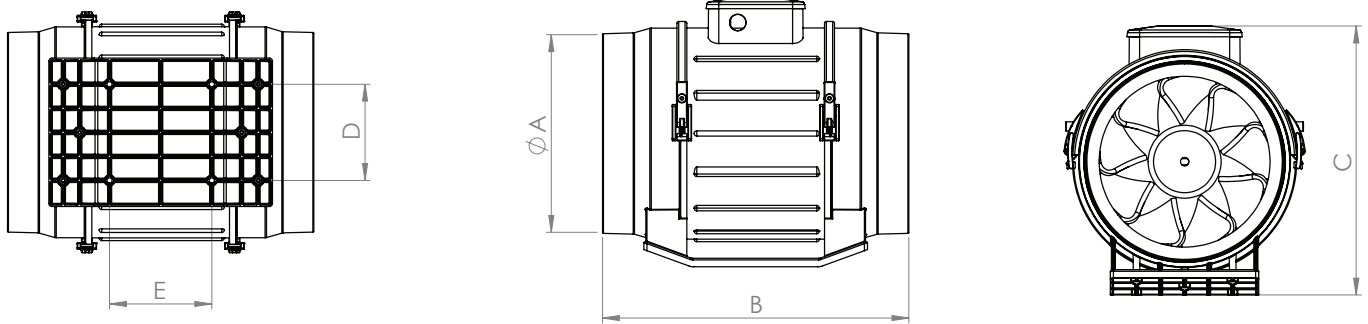

MODEL	A (mm)	B (mm)	C (mm)	D (mm)	E (mm)
KAF 100	96	306,5	215	60	80
KAF 125	121	260	215	60	80
KAF 150	146	290,5	242	60	80
KAF 160	156	271	242	60	80
KAF 200	191	300	263	94	100
KAF 250	246	393	325	110	140
KAF 315	310	450	420	175	180

PERFORMANS EĞRİLERİ

KAF 100

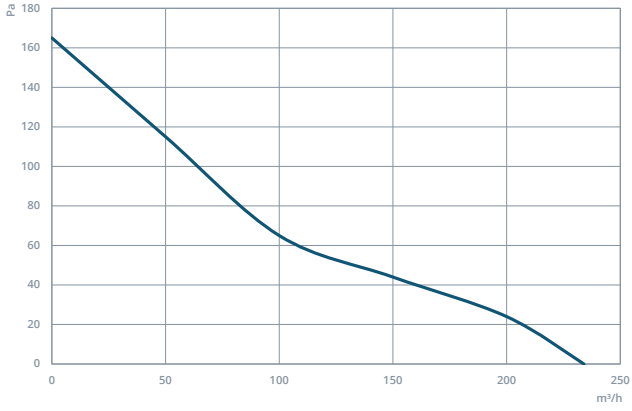

KAF 125

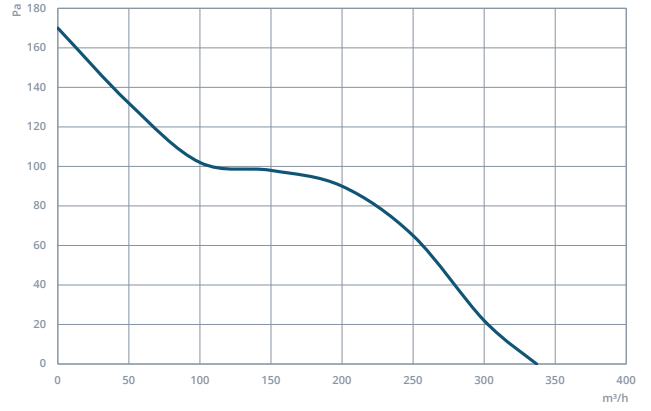

KAF 150

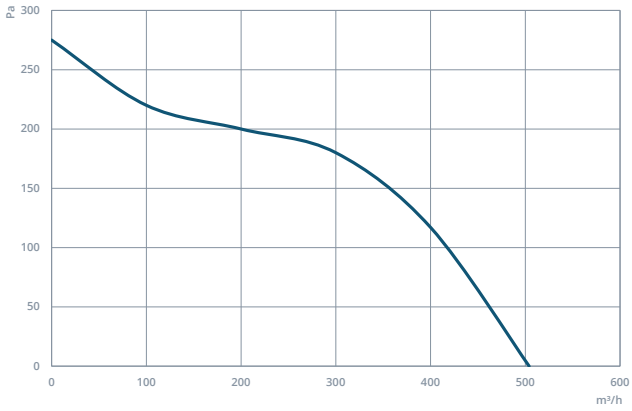

KAF 160

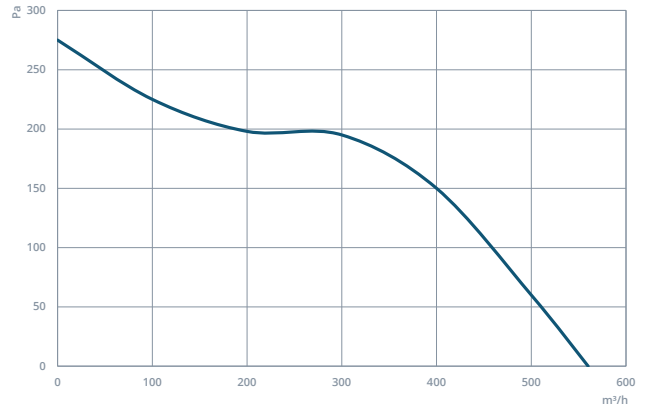

KAF 200

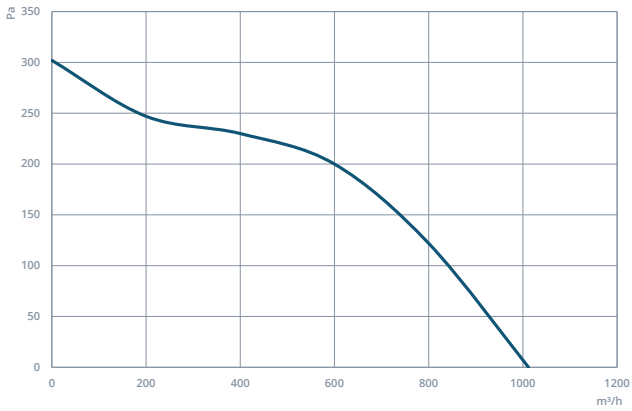

KAF 250

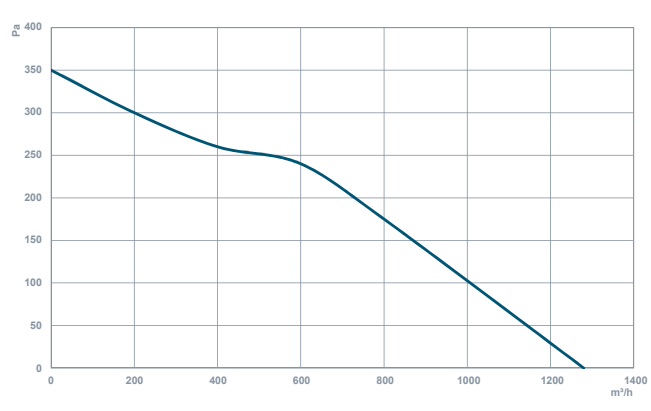

KAF 315

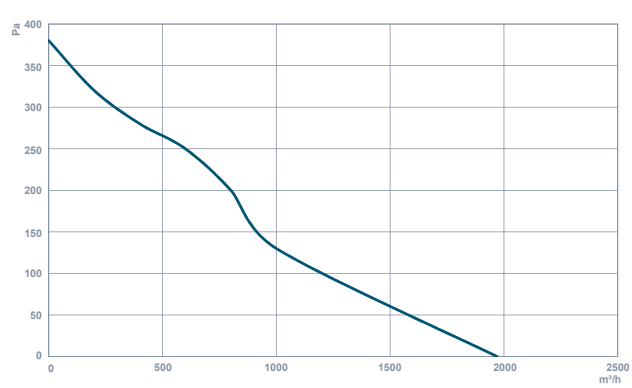

► RAD - Yuvarlak Kanal Tipi Radyal Fan

RAD fanlar düşük debili havalandırma ihtiyaçlarında kanala kolay montajı, sessiz çalışması ve düşük enerji tüketimi ile ideal bir tercihtir.



MOTOR YALITIM SINIFI	F SINIFI
MOTOR KORUMA SINIFI	IP 44
MOTOR VERİM SINIFI	-
MOTOR TİPİ	DIŞTAN ROTORLU MOTOR
MOTOR MARKASI	-
GÖVDE MALZEMESİ	GALVANİZE SAC
GÖVDE KAPLAMASI	-
PERVANE MALZEMESİ	GALVANİZE SAC
GÖREV DÖNGÜSÜ	IEC Duty Cycle-S1
ÇALIŞMA SICAKLIĞI	-20 - +50 °C
STANDARTLAR	IEC-60335-2-80, ISO 1940-1



MODEL	VOLTAJ (V)	FREKANS (Hz)	GÜÇ (W)	HIZ ANAHTARI MODELİ	DEVİR (d/dk)	DEBİ (m³/h)	SES SEVİYESİ (dB(A))	FİYAT (€/Adet)
RAD 100	230	50	80	KHA 2,5 A	2.600	290	45	58,00 €
RAD 125	230	50	80	KHA 2,5 A	2.600	410	45	64,00 €
RAD 150	230	50	85	KHA 2,5 A	2.600	600	46	68,00 €
RAD 160	230	50	85	KHA 2,5 A	2.600	620	48	68,00 €
RAD 200	230	50	122	KHA 2,5 A	2.675	1.000	48	89,00 €
RAD 250	230	50	145	KHA 2,5 A	2.685	1.120	50	93,00 €
RAD 315	230	50	210	KHA 2,5 A	2.615	1.750	53	107,00 €
RAD 355	230	50	380	KHA 2,5 A	2.480	2.200	56	230,00 €

Değerler 0 Pa içindir
HIZ ANAHTARI CİHAZ FİYATINA DAHİL DEĞİLDİR.

TEKNİK RESİM

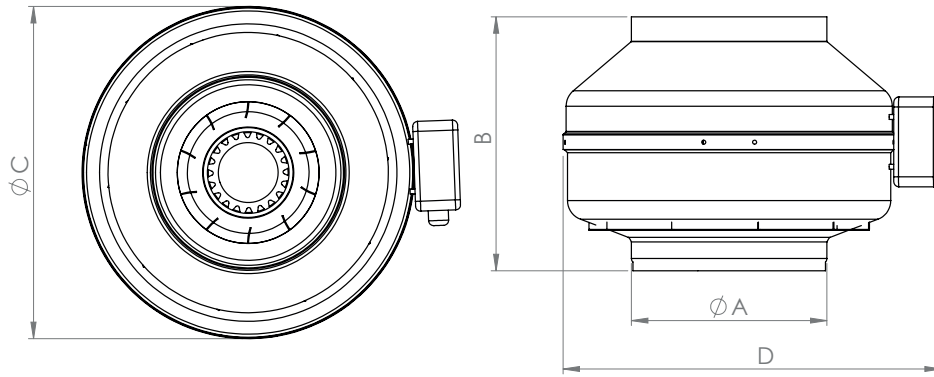

MODEL	A (mm)	B (mm)	C (mm)	D (mm)
RAD 100	100	208	246	290
RAD 125	125	208	246	290
RAD 150	150	196	270	320
RAD 160	160	196	270	320
RAD 200	200	255	333	380
RAD 250	250	234	331	380
RAD 315	315	234	401	450
RAD 355	355	225	401	450

PERFORMANS EĞRİLERİ

RAD 100

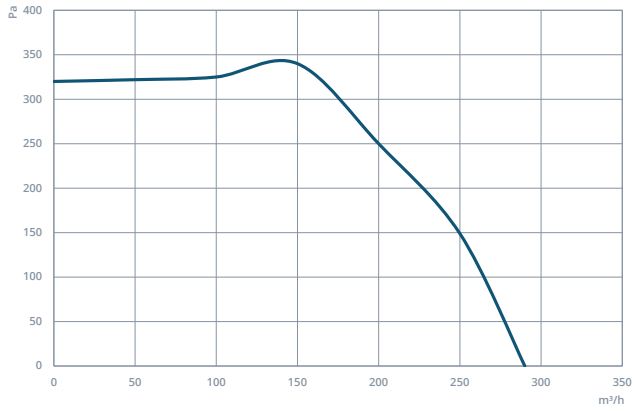

RAD 125

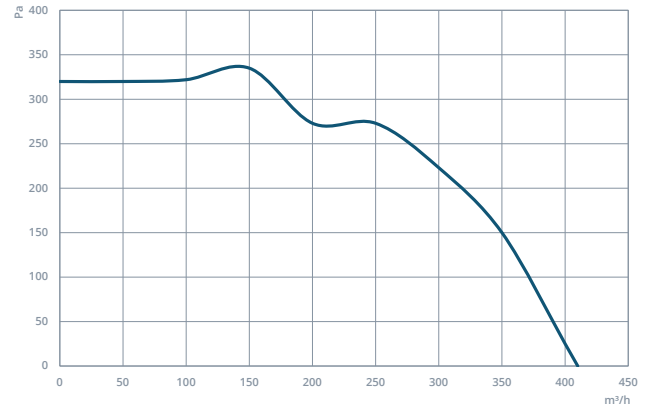

RAD 150

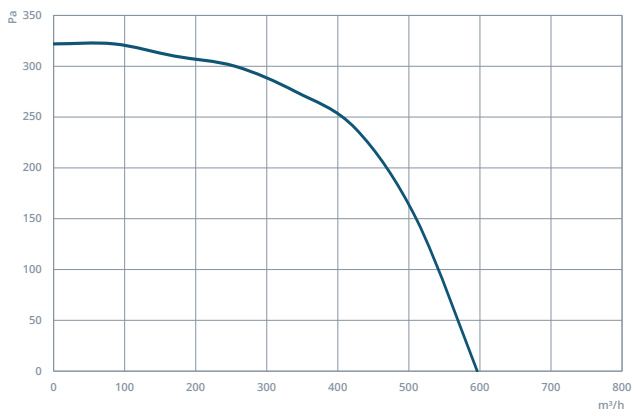

RAD 160

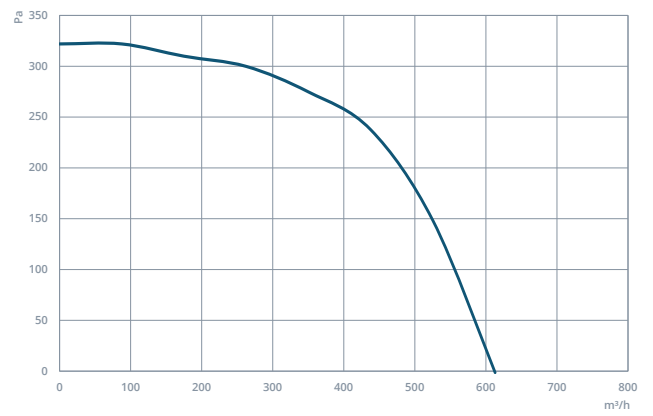

RAD 200

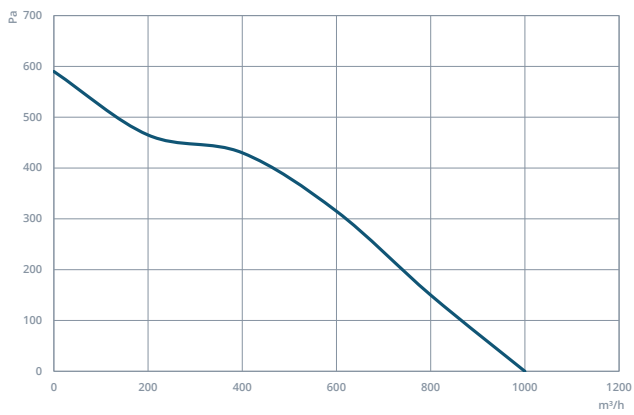

RAD 250

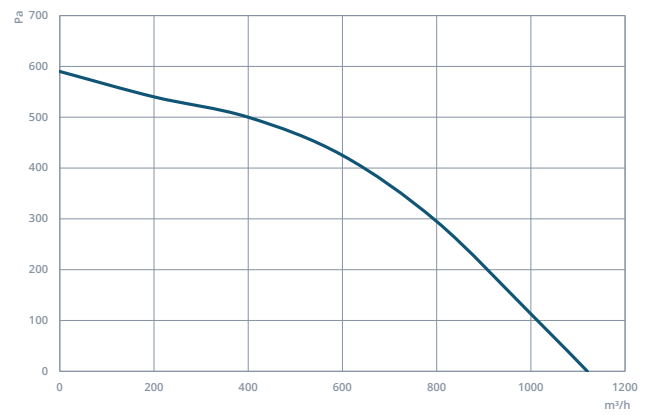

RAD 315

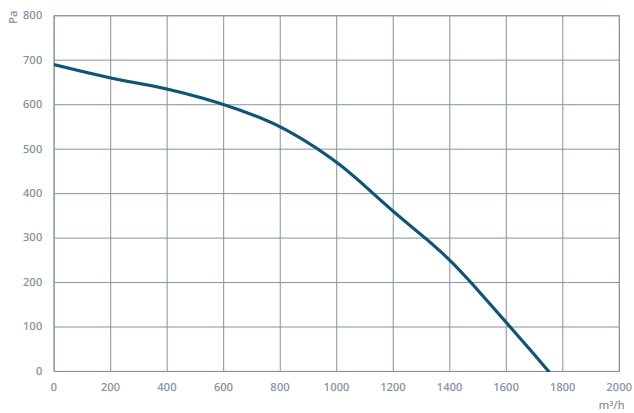

RAD 355

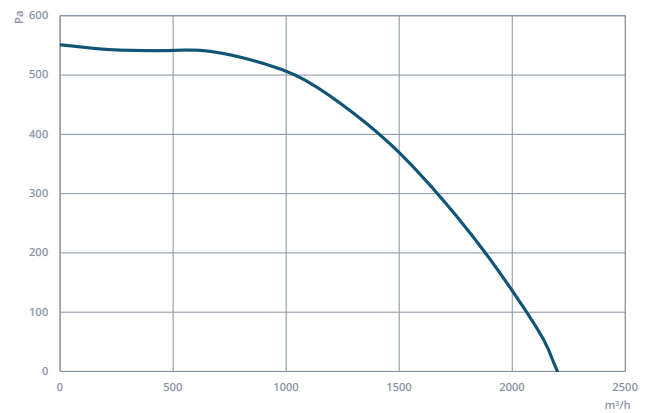

► REC - Prizmatik Kanal Tipi Radyal Fan

REC fanlar prizmatik kanallara doğrudan montajlanabilen yapısı, düşük enerji tüketimi ile ortam havalandırması ve egzozu projelerinde kullanılabilir. Müdahale kapağı ile ihtiyaç halinde fan temizliği kolaylıkla yapılabilir.



MOTOR YALITIM SINIFI	F SINIFI
MOTOR KORUMA SINIFI	IP 44
MOTOR VERİM SINIFI	-
MOTOR TİPİ	DIŞTAN ROTORLU MOTOR
MOTOR MARKASI	-
GÖVDE MALZEMESİ	GALVANİZE SAC
GÖVDE KAPLAMASI	-
PERVANE MALZEMESİ	GALVANİZE SAC - ALÜMİNYUM
GÖREV DÖNGÜSÜ	IEC Duty Cycle-S1
ÇALIŞMA SICAKLIĞI	-20 - +50 °C
STANDARTLAR	IEC-60335-2-80, ISO 1940-1



MODEL	VOLTAJ (V)	FREKANS (Hz)	GÜÇ (W)	HIZ ANAHTARI MODELİ	DEVİR (d/dk)	DEBİ (m³/h)	SES SEVİYESİ (dB(A))	FİYAT (€/Adet)
REC 30-15	230	50	90	KHA 2,5 A	2.600	520	51	137,00 €
REC 40-20 A	230	50	104	KHA 2,5 A	2.675	950	55	167,00 €
REC 40-20 B	230	50	130	KHA 2,5 A	2.685	1.150	59	179,00 €
REC 50-25	230	50	180	KHA 2,5 A	2.615	1.600	61	249,00 €
REC 60-30	230	50	147	KHA 2,5 A	1.360	2.350	57	398,00 €
REC 60-35	230	50	380	KHA 2,5 A	1.362	3.400	62	460,00 €
REC 70-40	230	50	690	KHA 2,5 A	1.367	4.900	63	670,00 €
REC 80-50	230-380	50	830	KHA 5 A - 1,10 KW	1.364	7.000	67	987,00 €
REC 100-50	380	50	1.460	2,20 kW	1.369	9.300	69	1.274,00 €

Değerler 0 Pa içindir

HIZ ANAHTARI VE FREKANS KONVERTÖRÜ CİHAZ FİYATLARINA DAHİL DEĞİLDİR.

TEKNİK RESİM

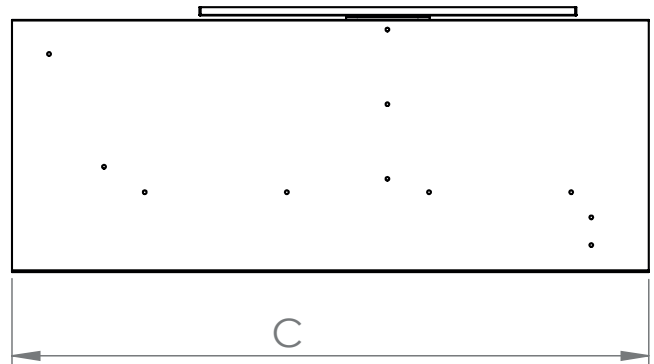
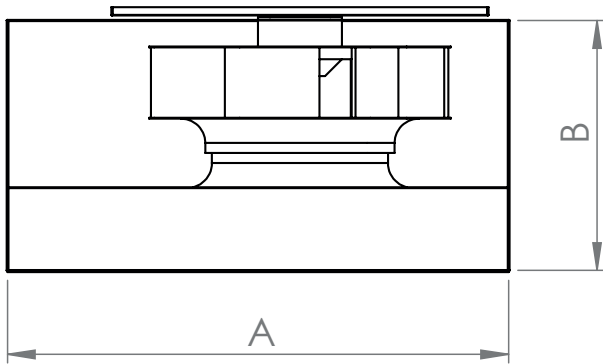

MODEL	A (mm)	B (mm)	C (mm)
REC 30-15	300	150	400
REC 40-20 A	400	200	500
REC 40-20 B	400	200	500
REC 50-25	500	250	565
REC 60-30	600	300	760
REC 60-35	600	350	765
REC 70-40	700	400	790
REC 80-50	800	500	900
REC 100-50	1000	500	1050

PERFORMANS EĞRİLERİ

REC 30-15

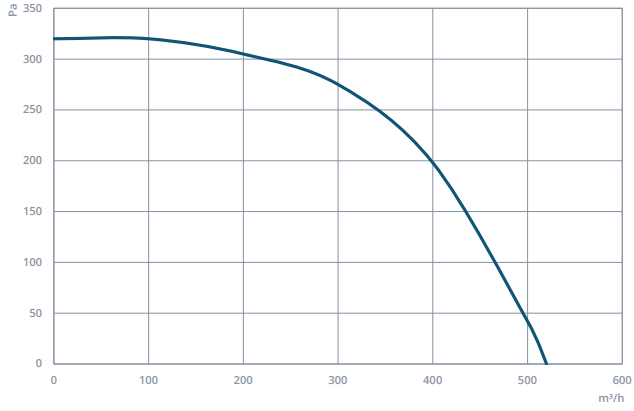

REC 40-20A

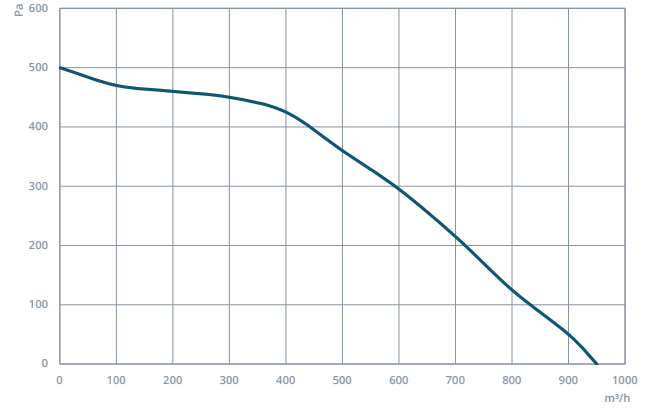

REC 40-20B

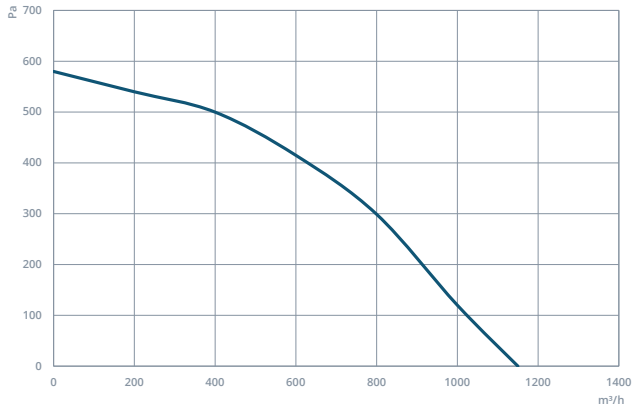

REC 50-25

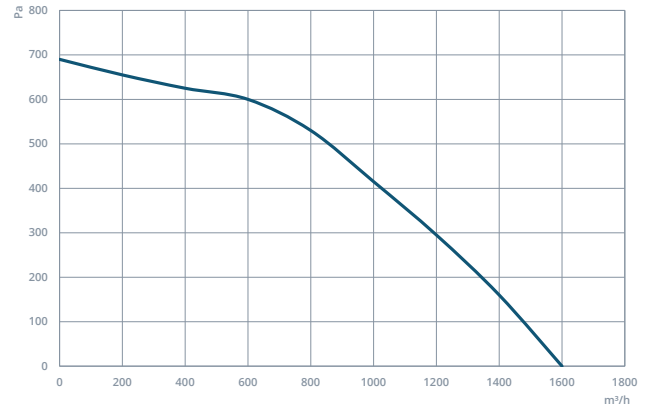

REC 60-30

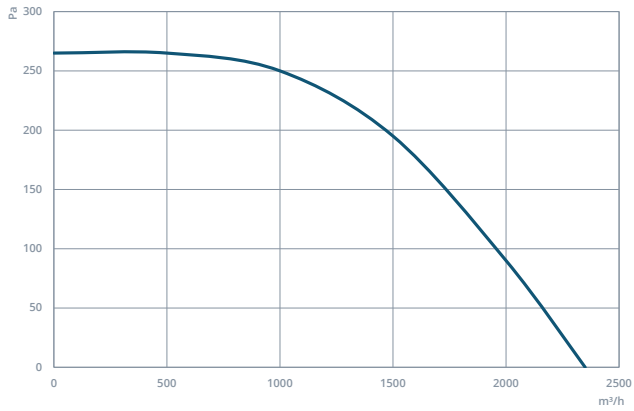

REC 60-35

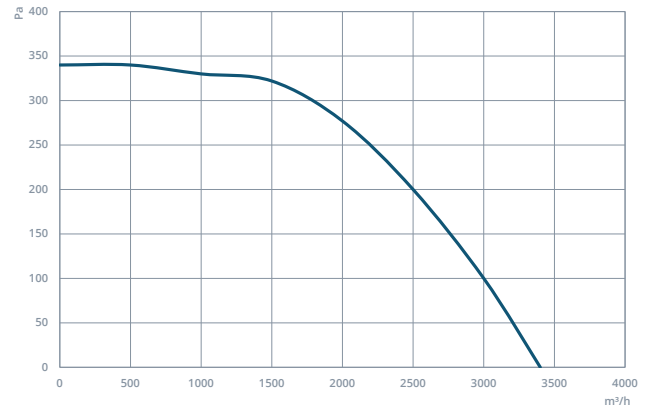

REC 70-40

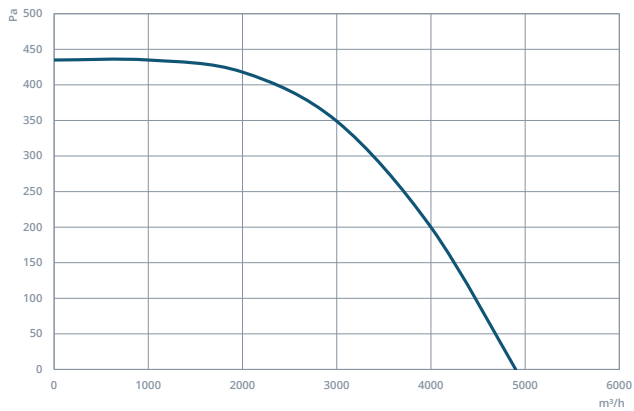

REC 80-50

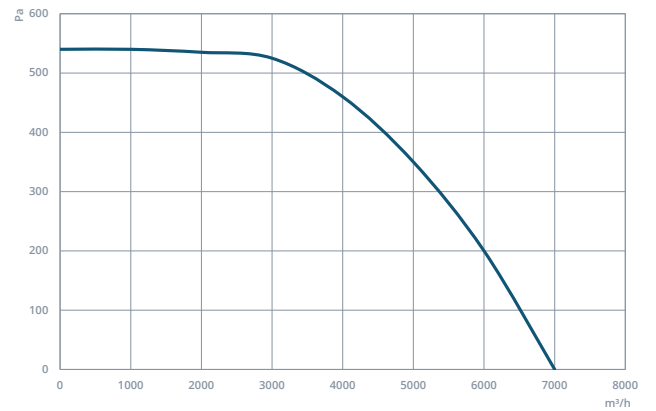

PERFORMANS EĞRİLERİ

REC 100-50

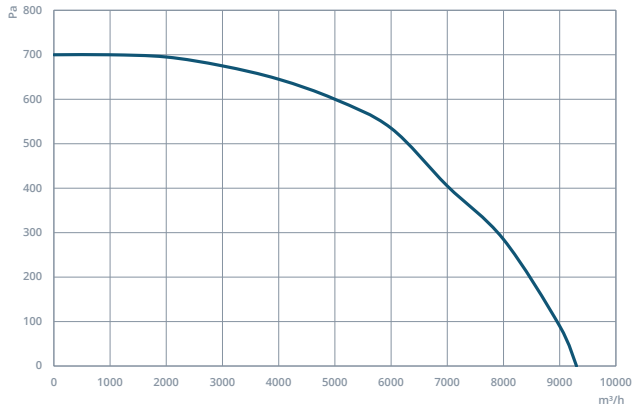

K YAĞ
DUMAN
O MUTFAK

L

A HAVA
LAN
Y DIRMA

► CUB - Yuvarlak Kanal Bağlantılı Prizmatik Fan

CUB fanları kübik gövdesi ve yuvarlak çıkışıyla doğrudan dairesel kanallara monte edilebilirler. Düşük enerji tüketimleri ile ortam havalandırması ve egzoz projelerinde kullanılabilirler. Müdahale kapağı ile gerektiğinde fan temizliği kolaylıkla yapılabilir. 4 mm XPE akustik yalıtımlı olarak üretilmektedir.



MOTOR YALITIM SINIFI	F SINIFI
MOTOR KORUMA SINIFI	IP 44
MOTOR VERİM SINIFI	-
MOTOR TİPİ	DIŞTAN ROTORLU MOTOR
MOTOR MARKASI	-
GÖVDE MALZEMESİ	GALVANİZE SAC
GÖVDE KAPLAMASI	GALVANİZE SAC
PERVANE MALZEMESİ	GALVANİZE SAC - ALÜMİNYUM
GÖREV DÖNGÜSÜ	IEC Duty Cycle-S1
ÇALIŞMA SICAKLIĞI	-20 - +50 °C
STANDARTLAR	IEC-60335-2-80, ISO 1940-1

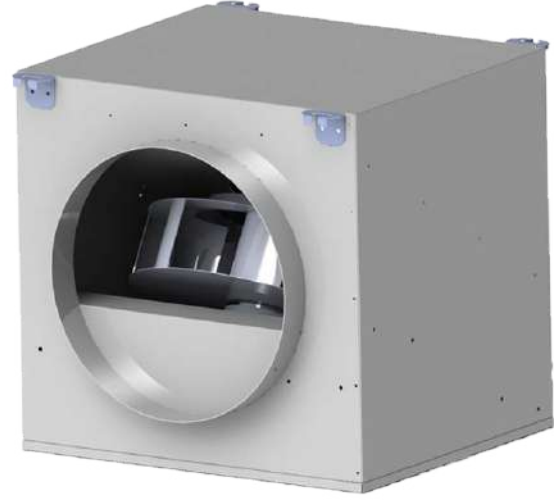

MODEL	VOLTAJ (V)	FREKANS (Hz)	GÜÇ (W)	HIZ ANAHTARI MODELİ	DEVİR (d/dk)	DEBİ (m³/h)	SES SEVİYESİ (dB(A))	FİYAT (€/Adet)
CUB 100	230	50	80	KHA 2,5 A	2.600	290	44	126,00 €
CUB 125	230	50	80	KHA 2,5 A	2.600	410	46	130,00 €
CUB 150	230	50	85	KHA 2,5 A	2.600	700	50	158,00 €
CUB 160	230	50	85	KHA 2,5 A	2.600	710	52	158,00 €
CUB 200	230	50	122	KHA 2,5 A	2.675	1.000	55	183,00 €
CUB 250	230	50	145	KHA 2,5 A	2.685	1.120	62	206,00 €
CUB 315	230	50	210	KHA 2,5 A	2.615	1.750	63	287,00 €
CUB 355	230	50	380	KHA 2,5 A	1.410	2.200	68	384,00 €
CUB 400	230	50	380	KHA 2,5 A	1.362	3.400	70	515,00 €
CUB 450	230	50	690	KHA 2,5 A	1.367	4.900	74	770,00 €
CUB 500	230-380	50	830	KHA 5 A - 1,10 KW	1.364	7.000	77	1.135,00 €
CUB 560	380	50	1460	2,20 KW	1.369	9.300	79	1.175,00 €

Değerler 0 Pa içindir

HIZ ANAHTARI VE FREKANS KONVERTÖRÜ CİHAZ FİYATLARINA DAHİL DEĞİLDİR.

TEKNİK RESİM

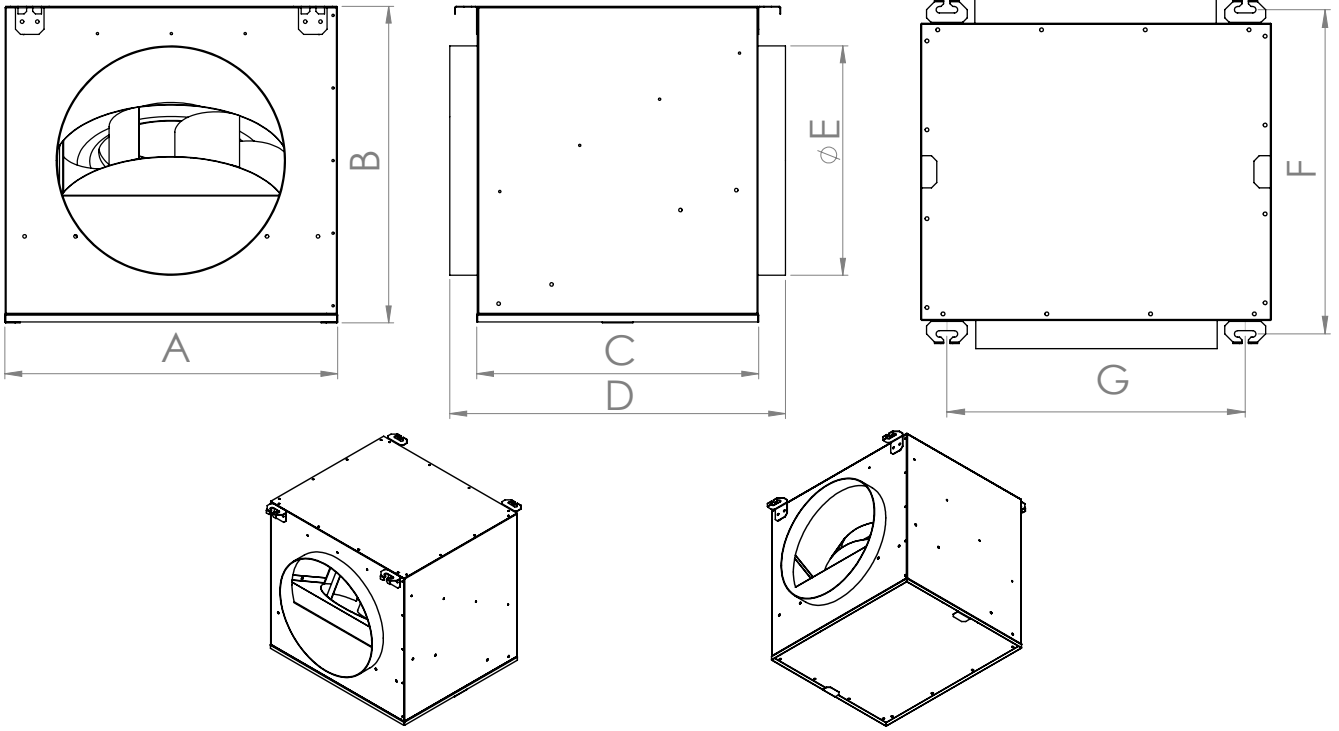

MODEL	A (mm)	B (mm)	C (mm)	D (mm)	E (mm)	F (mm)	G (mm)
CUB 100	342	342	304	410	100	354	246
CUB 125	342	342	304	410	125	354	246
CUB 150	342	361	304	410	150	354	246
CUB 160	342	381	304	410	160	354	246
CUB 200	392	381	354	460	225	404	296
CUB 250	472	422	354	460	250	404	382
CUB 315	502	446	404	510	315	454	406
CUB 355	572	522	454	560	355	504	574
CUB 400	602	622	554	660	400	604	506
CUB 450	652	622	554	660	450	604	556
CUB 500	702	672	604	710	500	606	654
CUB 560	752	802	604	710	560	604	656

PERFORMANS EĞRİLERİ

CUB 100

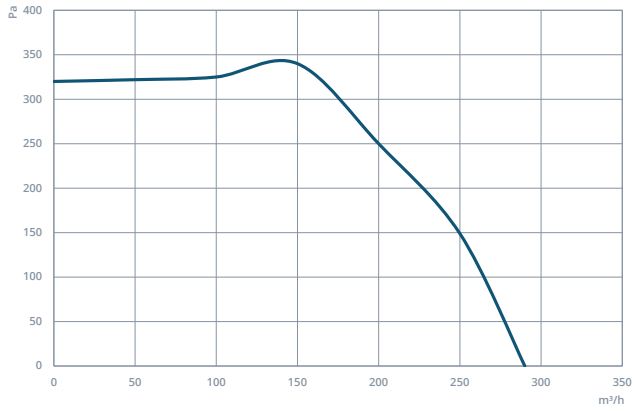

CUB 125

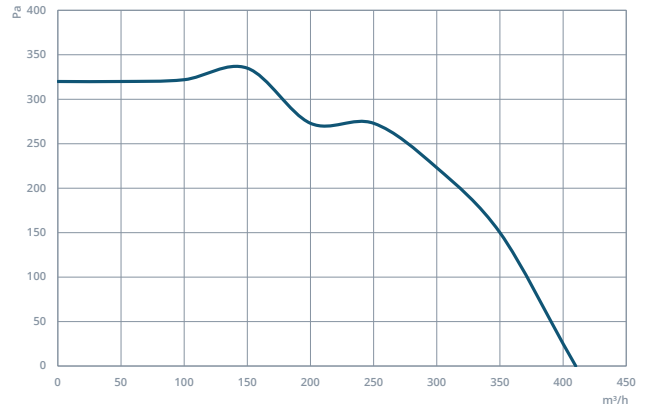

CUB 150

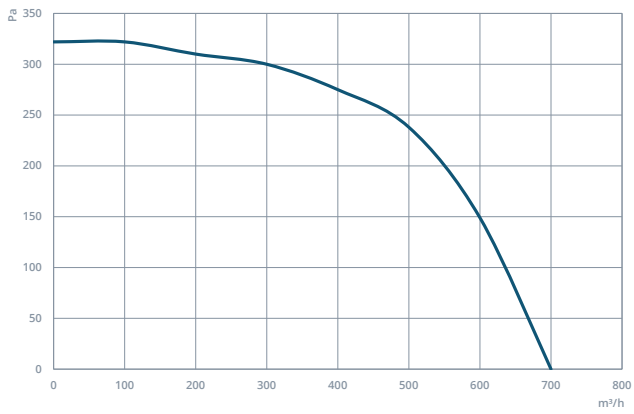

CUB 160

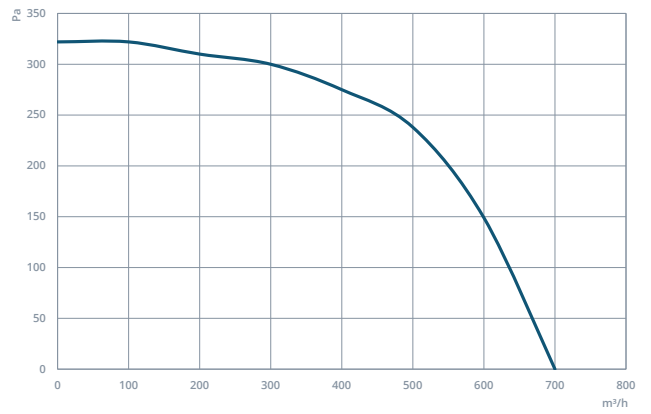

CUB 200

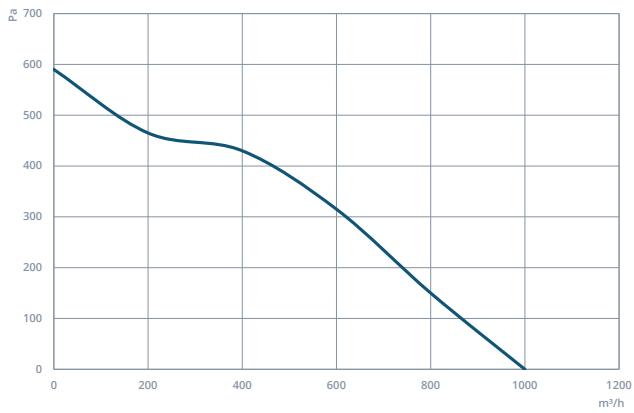

CUB 250

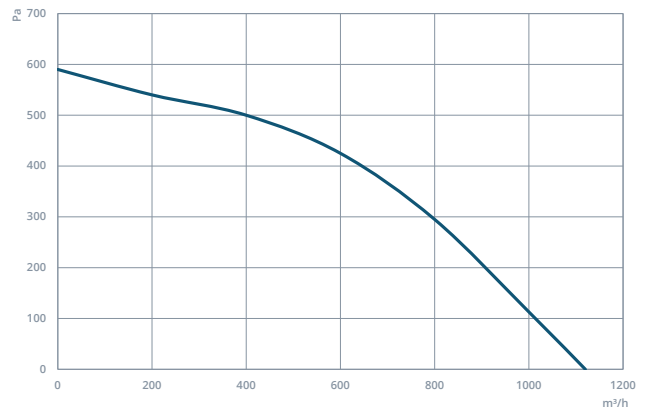

CUB 315

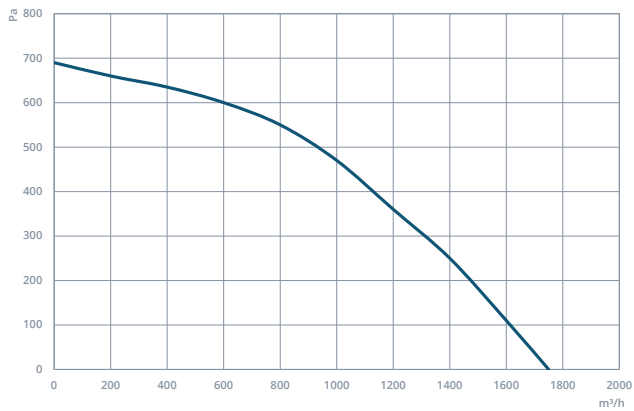

CUB 355

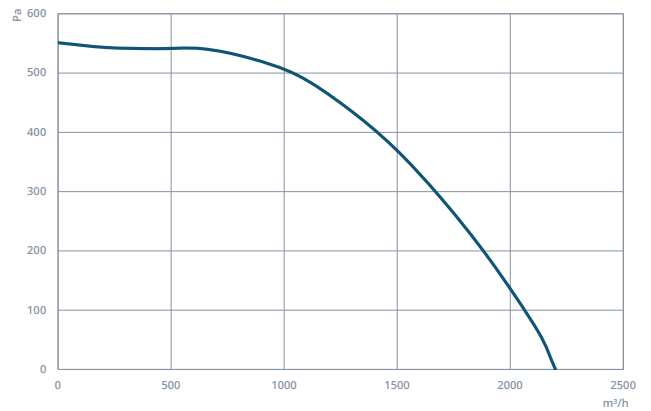

PERFORMANS EĞRİLERİ

CUB 400

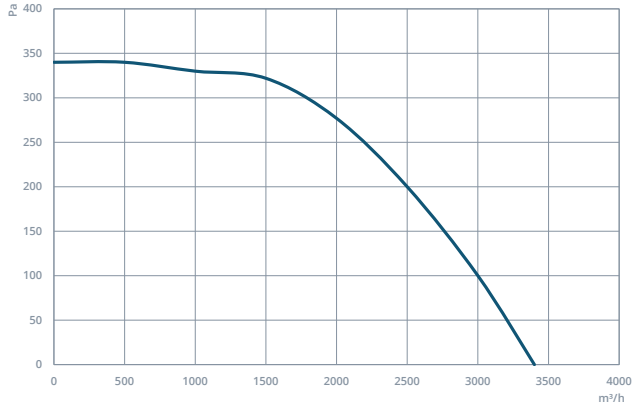

CUB 450

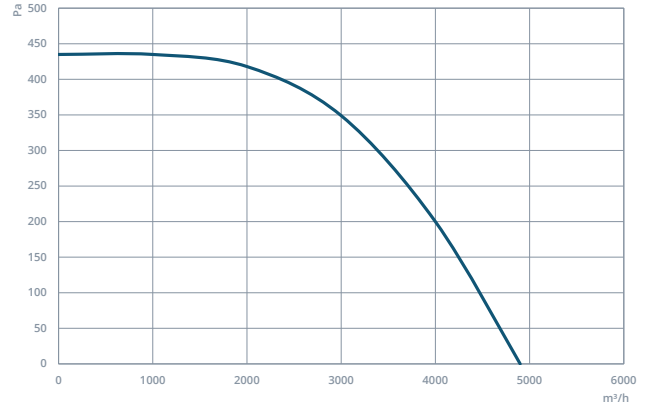

CUB 500

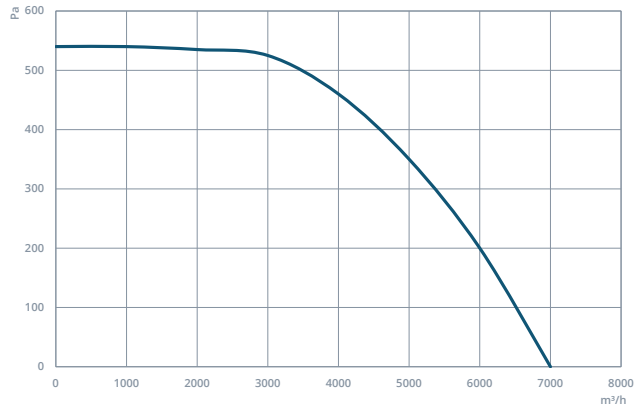

CUB 560

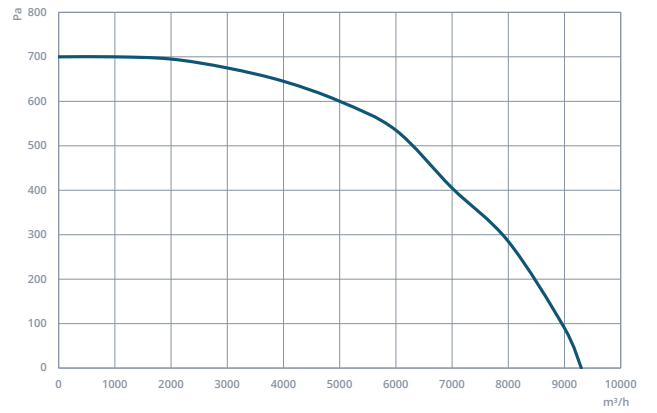

► DREC - Dıştan Motorlu Prizmatik Kanal Tipi Radyal Fan

DREC fanlar prizmatik kanallara doğrudan montajlanabilen yapısı, düşük enerji tüketimi ile ortam havalandırması için kullanılabilir. Müdahale kapağı ile ihtiyaç halinde fan temizliği kolaylıkla yapılabilir. Motor hava akımının dışında olduğu için motor geçen havadaki yabancı maddelerden etkilenmez.



MOTOR YALITIM SINIFI	F SINIFI
MOTOR KORUMA SINIFI	IP 55
MOTOR VERİM SINIFI	IE3
MOTOR TİPİ	TEFC
MOTOR MARKASI	-
GÖVDE MALZEMESİ	GALVANİZE SAC
GÖVDE KAPLAMASI	YOK
PERVANE MALZEMESİ	GALVANİZE SAC - ALÜMİNYUM
GÖREV DÖNGÜSÜ	IEC Duty Cycle-S1
ÇALIŞMA SICAKLIĞI	-20 - +50 °C
STANDARTLAR	IEC-60335-2-80, ISO 1940-1

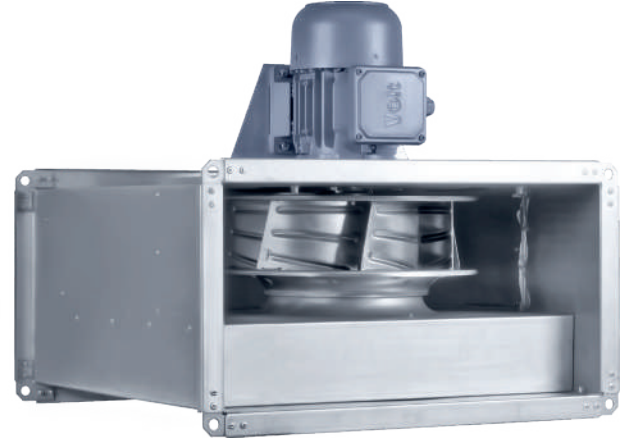

MODEL	VOLTAJ (V)	FREKANS (Hz)	GÜÇ (kW)	DEVİR (d/dk)	DEBİ (m³/h)	SES SEVİYESİ (dB(A))	FİYAT (€/Adet)
DREC 280	380	50	0,18	1.450	1.100	58	470,00 €
DREC 315	380	50	0,25	1.469	1.600	58	520,00 €
DREC 355	380	50	0,37	1.471	2.300	60	540,00 €
DREC 400	380	50	0,55	1.478	3.300	61	650,00 €
DREC 450	380	50	0,75	1.454	5.000	63	800,00 €
DREC 500	380	50	1,10	1.462	7.000	67	950,00 €
DREC 560	380	50	1,50	1.464	9.800	70	1.300,00 €

Değerler 0 Pa içindir

1,5 kW'a Kadar Monofaze Motor Takılabilir. Monofaze Motorlu İstenirse Mevcut Fiyata %20 Fark Uygulanır.

TEKNİK RESİM

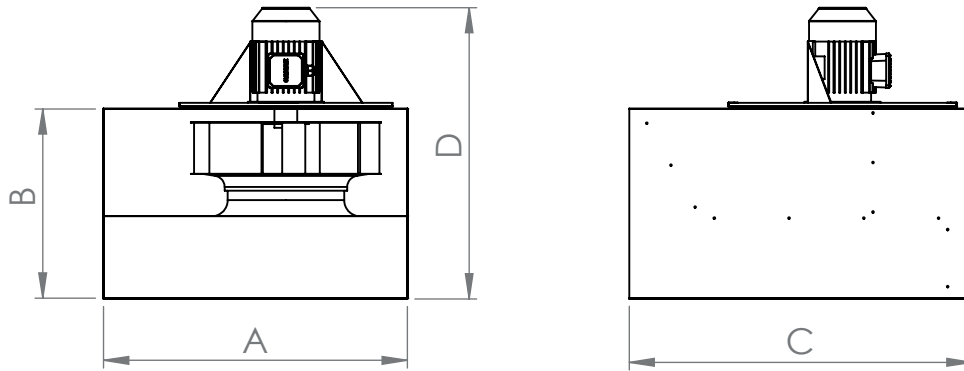

MODEL	A (mm)	B (mm)	C (mm)	D (mm)
DREC 280	500	250	565	450
DREC 315	500	250	565	476
DREC 355	600	300	760	526
DREC 400	600	350	750	590
DREC 450	700	400	790	641
DREC 500	800	500	900	765
DREC 560	1000	500	1050	790

PERFORMANS EĞRİLERİ

DREC 280

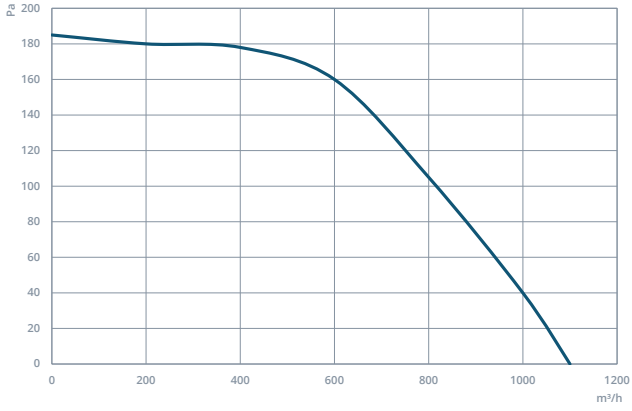

DREC 315

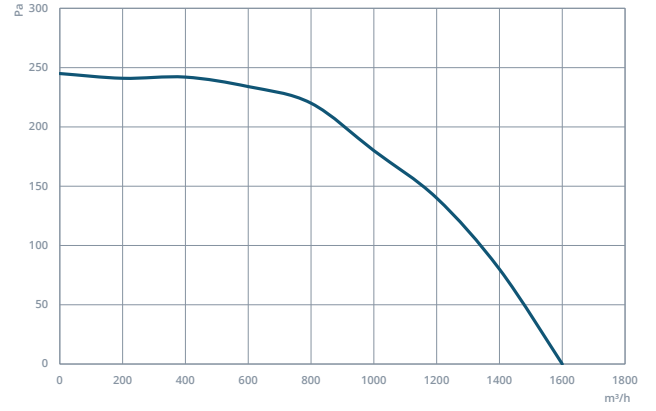

DREC 355

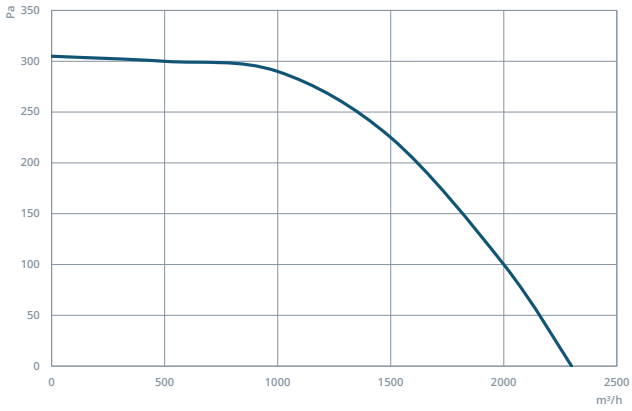

DREC 400

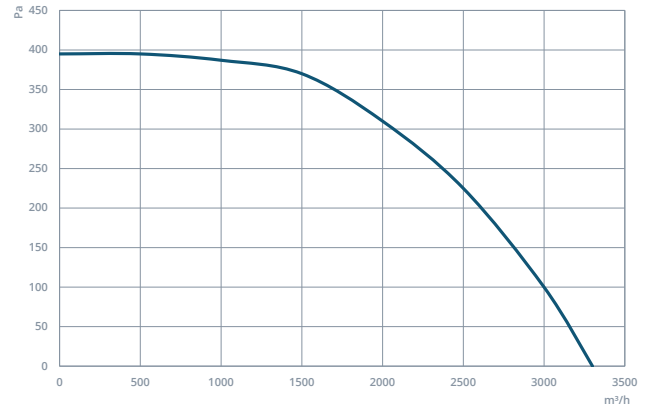

DREC 450

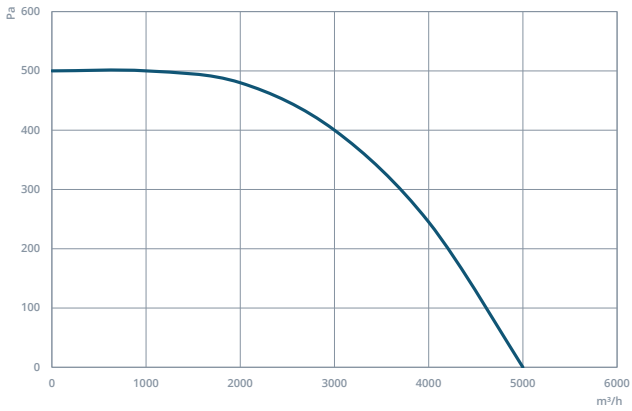

DREC 500

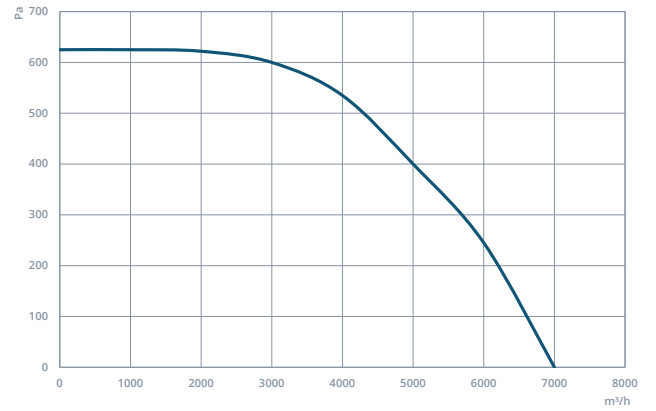

DREC 560

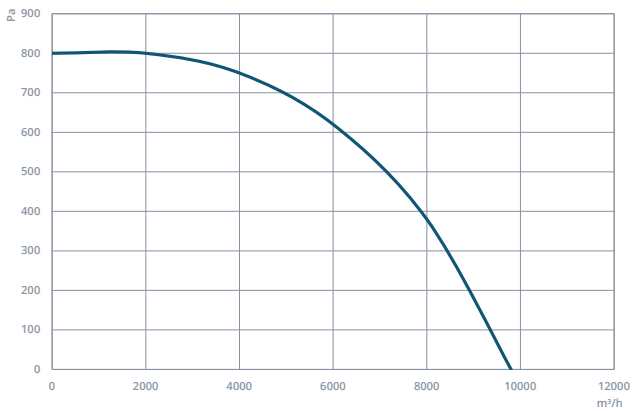

► MEF - Mutfak Davlumbaz Fanı

MEF mutfakların davlumbazlarına bağlanarak ocak, ızgara, kızartma tezgahı gibi mutfak ekipmanlarının çıkardığı dumanı çekerek ortamın duman dolmasını ve ağır kokuları engeller. Kolay müdahale kapağı ile pervane temizliği yapılabilir. Motor hava akımının dışında olduğu için yağlı ve ıslı havadan etkilenmez.



MOTOR YALITIM SINIFI	F SINIFI
MOTOR KORUMA SINIFI	IP 55
MOTOR VERİM SINIFI	IE3
MOTOR TİPİ	TEFC
MOTOR MARKASI	-
GÖVDE MALZEMESİ	GALVANİZE SAC
GÖVDE KAPLAMASI	YOK
PERVANE MALZEMESİ	ALÜMİNYUM
GÖREV DÖNGÜSÜ	IEC Duty Cycle-S1
ÇALIŞMA SICAKLIĞI	-20 - +50 °C
STANDARTLAR	IEC-60335-2-80, ISO 1940-1



MODEL	VOLTAJ (V)	FREKANS (Hz)	GÜÇ (kW)	DEVİR (d/dk)	DEBİ (m³/h)	SES SEVİYESİ (dB(A))	FİYAT (€/Adet)
MEF 315	380	50	0,25	1.469	1.600	37	710,00 €
MEF 355	380	50	0,37	1.471	2.300	41	790,00 €
MEF 400	380	50	0,55	1.478	3.300	42	900,00 €
MEF 450	380	50	0,75	1.454	5.000	45	1.060,00 €
MEF 500	380	50	1,10	1.462	7.000	49	1.260,00 €

Değerler 0 Pa içindir

1,5 kW'a Kadar Monofaze Motor Takılabilir. Monofaze Motorlu İstenirse Mevcut Fiyata %20 Fark Uygulanır.

TEKNİK RESİM

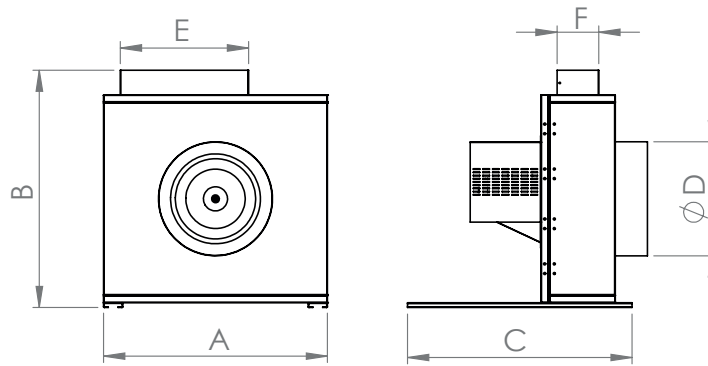

MODEL	A (mm)	B (mm)	C (mm)	D (mm)	E (mm)	F (mm)
MEF 315	650	690	700	315	300	110
MEF 355	700	740	700	355	400	130
MEF 400	750	790	700	400	400	150
MEF 450	800	840	700	450	400	170
MEF 500	850	890	700	500	440	190

PERFORMANS EĞRİLERİ

MEF 315

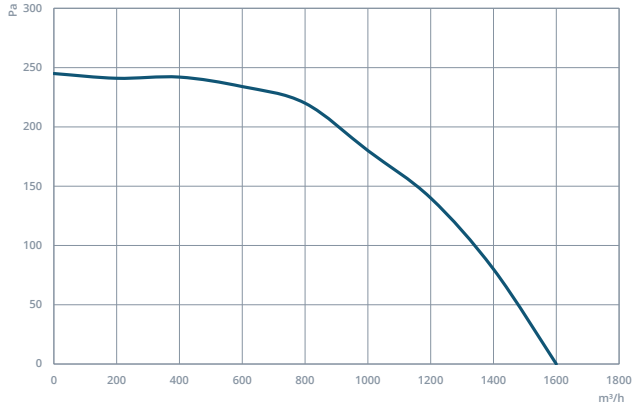

MEF 355

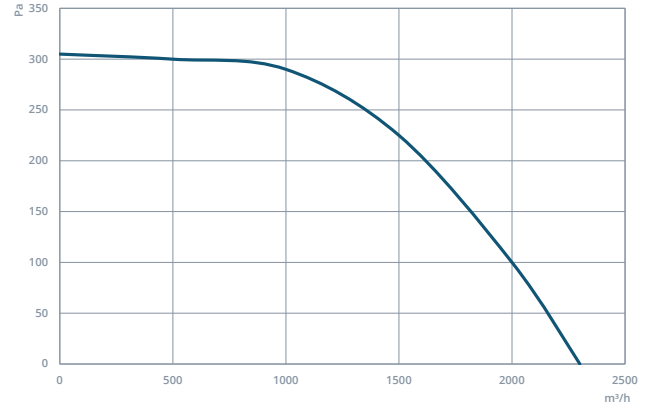

MEF 400

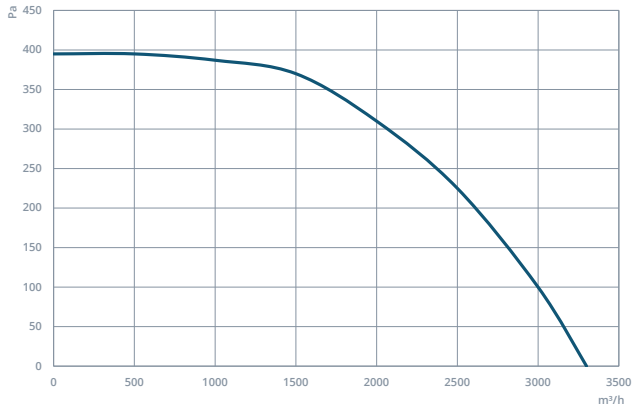

MEF 450

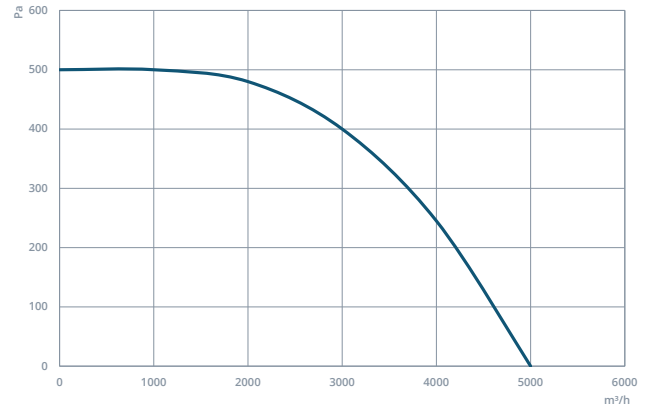

MEF 500

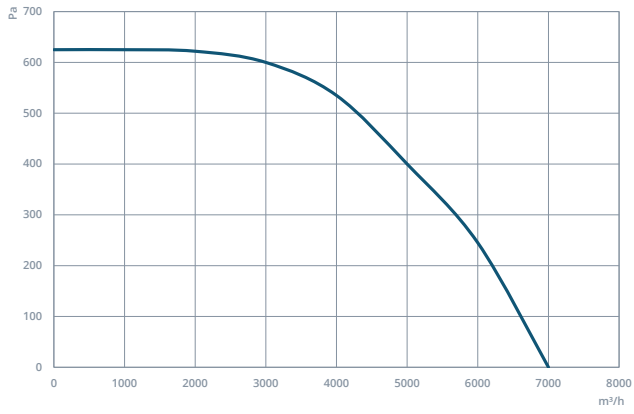

► HMEF - Hücreli Mutfak Davlumbaz Fanı

HMEF mutfakların davlumbazlarına bağlanarak ocak, ızgara, kızartma tezgahı gibi mutfak ekipmanlarının çıkardığı dumanı çekerek ortamın duman dolmasını ve ağır kokuları engeller. Kapalı gelen fanın istenilen kenar parçası çıkartılıp kullanılabilir. Motoru hava akımının dışında olduğu için yağlı ve isli havadan etkilenmez.



MOTOR YALITIM SINIFI	F SINIFI
MOTOR KORUMA SINIFI	IP 55
MOTOR VERİM SINIFI	IE3
MOTOR TİPİ	TEFC
MOTOR MARKASI	-
GÖVDE MALZEMESİ	GALVANİZE SAC
GÖVDE KAPLAMASI	ELEKTRO-STATİK TOZ BOYA
PERVANE MALZEMESİ	ALÜMİNYUM
GÖREV DÖNGÜSÜ	IEC Duty Cycle-S1
ÇALIŞMA SICAKLIĞI	-20 - +50 °C
STANDARTLAR	IEC-60335-2-80, ISO 1940-1

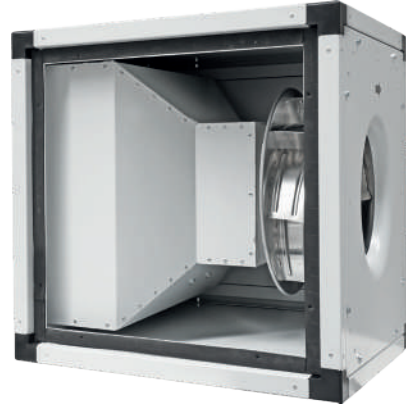

MODEL	VOLTAJ (V)	FREKANS (Hz)	GÜÇ (kW)	DEVİR (d/dk)	DEBİ (m³/h)	SES SEVİYESİ (dB(A))	FİYAT (€/Adet)
HMEF 280	380	50	0,18	1.450	1.100	37	534,00 €
HMEF 315	380	50	0,25	1.469	1.600	38	674,00 €
HMEF 355	380	50	0,37	1.471	2.300	43	703,00 €
HMEF 400	380	50	0,55	1.478	3.300	45	838,00 €
HMEF 450	380	50	0,75	1.454	5.000	50	1.060,00 €
HMEF 500	380	50	1,10	1.462	7.000	53	1.260,00 €
HMEF 560	380	50	1,50	1.464	9.800	56	1.515,00 €
HMEF 630	380	50	3,00	1.465	14.000	59	1.850,00 €
HMEF 710	380	50	4,00	950	13.000	55	2.451,00 €

Değerler 0 Pa içindir

1,5 kW'a Kadar Monofaze Motor Takılabilir. Monofaze Motorlu İstenirse Mevcut Fiyata %20 Fark Uygulanır.

TEKNİK RESİM

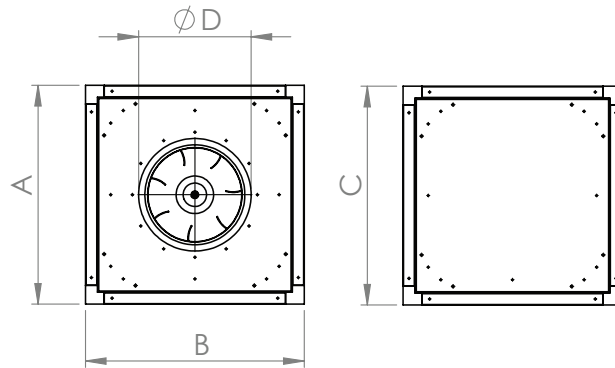

MODEL	A (mm)	B (mm)	C (mm)	D (mm)
HMEF 280	450	450	450	280
HMEF 315	500	500	500	315
HMEF 355	500	500	500	355
HMEF 400	600	600	600	400
HMEF 450	700	700	700	450
HMEF 500	800	800	800	500
HMEF 560	900	900	900	560
HMEF 630	1000	1000	1000	630
HMEF 710	1100	1100	1100	710

PERFORMANS EĞRİLERİ

HMEF 280

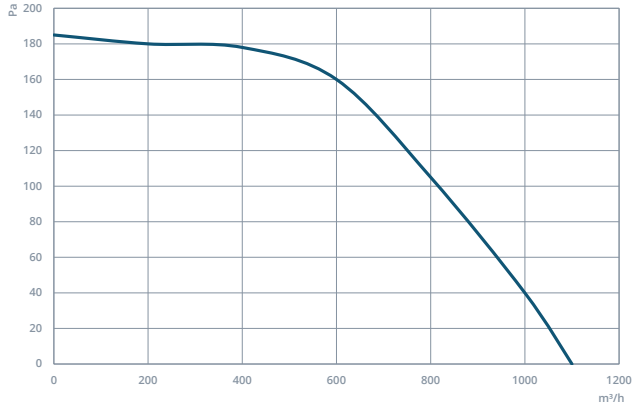

HMEF 315

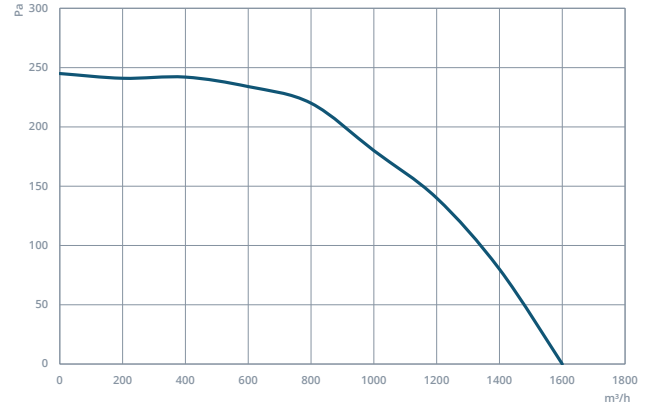

HMEF 355

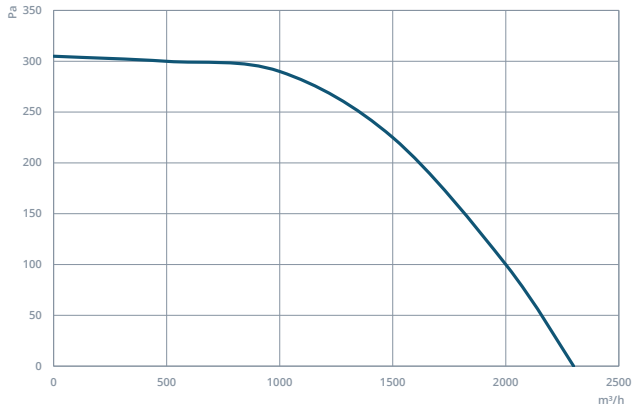

HMEF 400

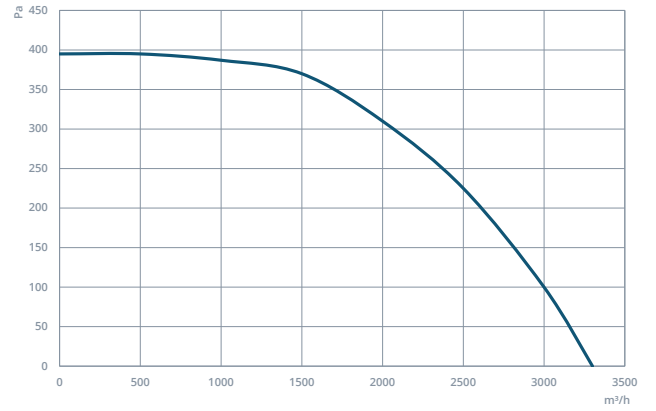

HMEF 450

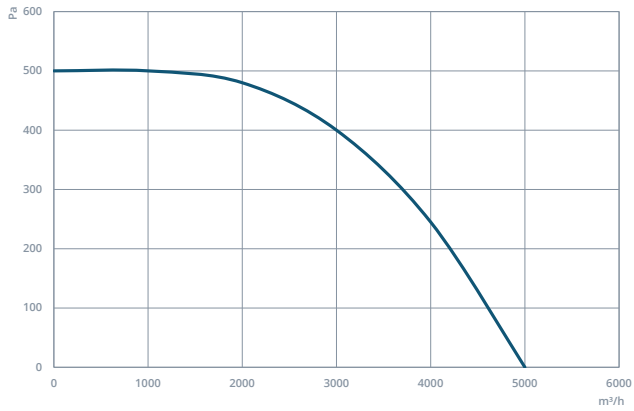

HMEF 500

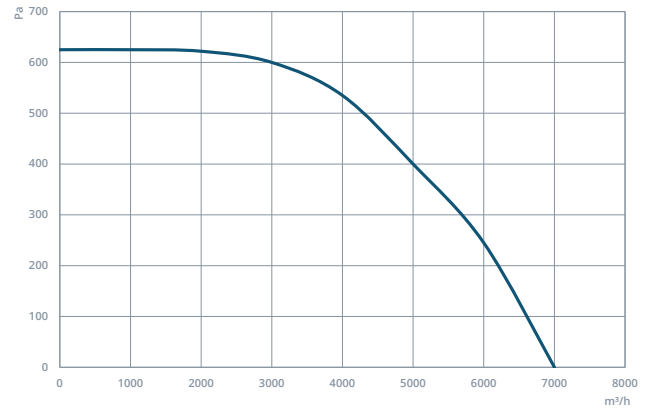

HMEF 560

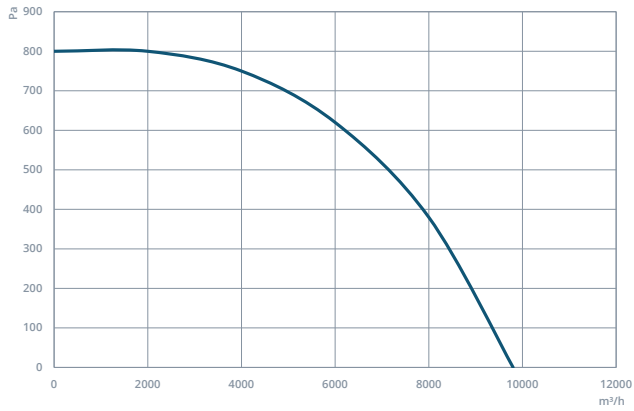

HMEF 630

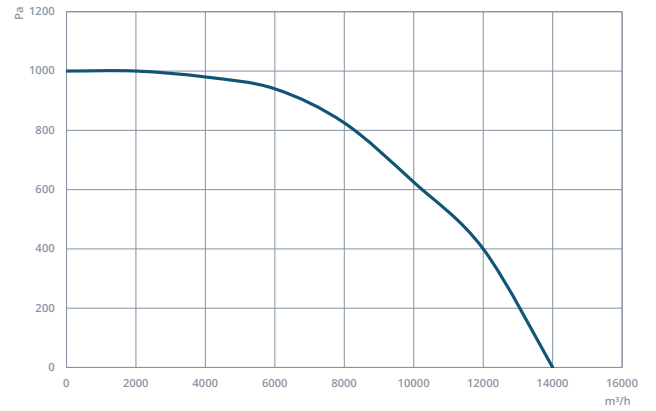

PERFORMANS EĞRİLERİ

HMEF 710

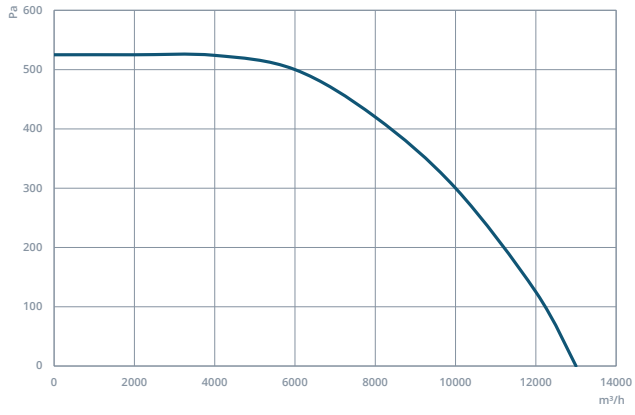

K MUTFAK

KOKU

O BAKIM

L

A HAVA

LAN

Y DIRMA

► KASP - Aktif Karbon Filtreli Mutfak Egzoz Fanı

KASP fanlar otel, restoran mutfağı gibi endüstriyel ve ticari mutfaklarda davlumbaz egzoz havasının misafirleri rahatsız etmesini engellemek için tasarlanmıştır. Kızaklı tasarımı filtre ve fanı kolay temizlik ve bakım sağlar. Standart olarak Yağ Tutucu (Metal dolu) Filtre, G2 Toz Filtresi ve Aktif Karbon Filtre



MOTOR YALITIM SINIFI	F SINIFI
MOTOR KORUMA SINIFI	IP 44
MOTOR VERİM SINIFI	-
MOTOR TİPİ	DIŞTAN ROTORLU MOTOR
MOTOR MARKASI	-
GÖVDE MALZEMESİ	GALVANİZE SAC
GÖVDE KAPLAMASI	ELEKTRO-STATİK TOZ BOYA
PERVANE MALZEMESİ	GALVANİZE SAC
GÖREV DÖNGÜSÜ	IEC Duty Cycle-S1
ÇALIŞMA SICAKLIĞI	-20 - +50 °C
STANDARTLAR	IEC-60335-2-80, ISO 1940-1



MODEL	VOLTAJ (V)	FREKANS (Hz)	GÜÇ (W)	DEVİR (d/dk)	DEBİ (m ³ /h)	SES SEVİYESİ (dB(A))	FİYAT (€/Adet)
KASP 400	230	50	380	1.362	2.400	45	2.235,00 €
KASP 450	230	50	690	1.367	3.300	48	2.478,00 €
KASP 500	230-380	50	830	1.364	5.200	52	3.269,00 €
KASP 560	380	50	1.460	1.369	7.200	55	3.777,00 €

Değerler 0 Pa içindir

TEKNİK RESİM

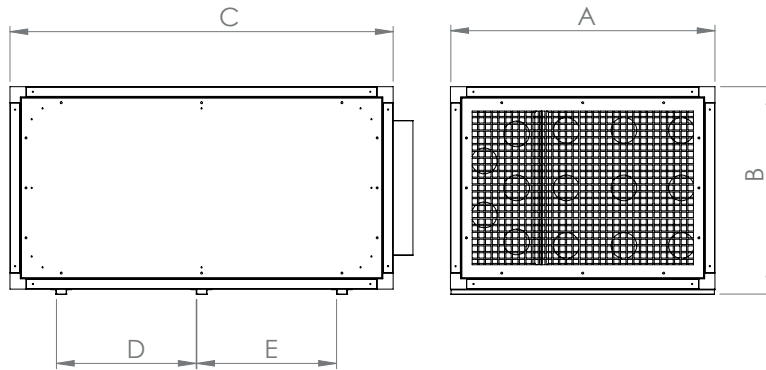

MODEL	A (mm)	B (mm)	C (mm)	D (mm)	E (mm)
KASP 400	665	750	1420	520	520
KASP 450	665	750	1420	520	520
KASP 500	980	750	1420	520	520
KASP 560	980	750	1420	520	520

PERFORMANS EĞRİLERİ

KASP 400

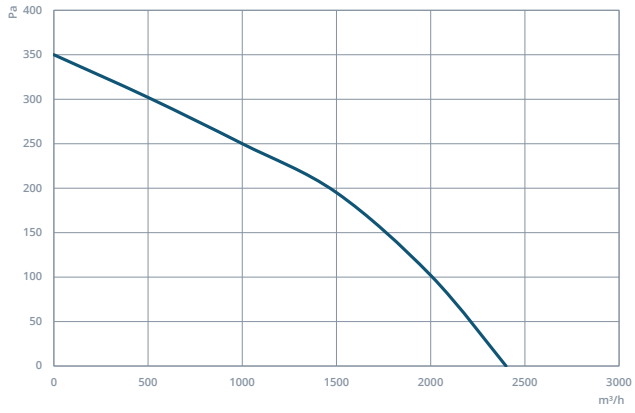

KASP 450

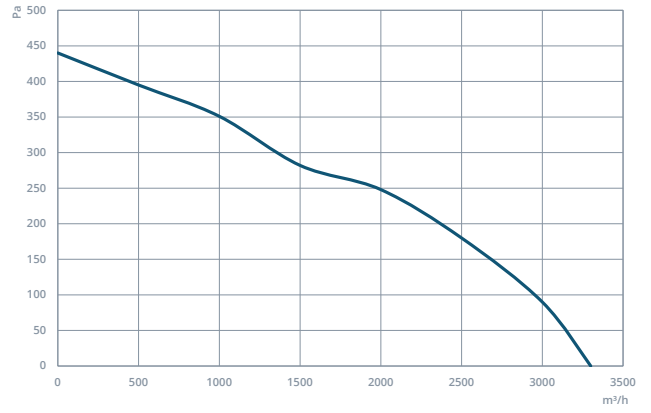

KASP 500

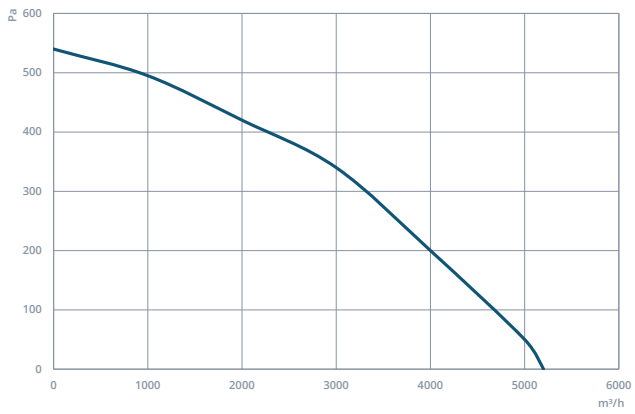

KASP 560

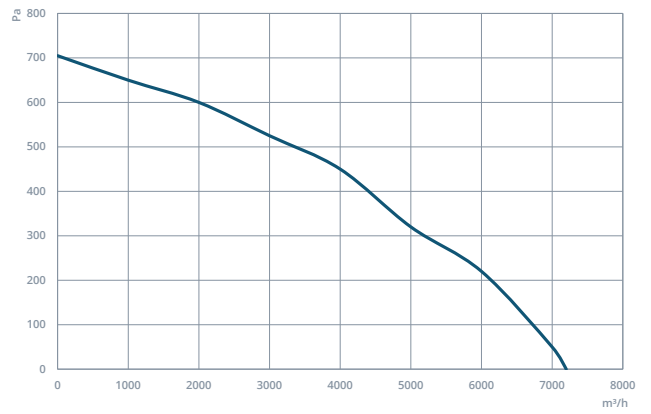

► HASP - Hücreli Radyal Fan

HASP fanlar kolay montajı, sağlam yapısı ve yüksek debi üretebilen verimli pervanesiyle havalandırma ihtiyaçlarında kullanılabilir.



MOTOR YALITIM SINIFI	F SINIFI
MOTOR KORUMA SINIFI	IP 55
MOTOR VERİM SINIFI	IE3
MOTOR TİPİ	TEFC
MOTOR MARKASI	-
GÖVDE MALZEMESİ	GALVANİZE SAC
GÖVDE KAPLAMASI	ELEKTRO-STATİK TOZ BOYA
PERVANE MALZEMESİ	ALÜMİNYUM
GÖREV DÖNGÜSÜ	IEC Duty Cycle-S1
ÇALIŞMA SICAKLIĞI	-20 - +50 °C
STANDARTLAR	IEC-60335-2-80, ISO 1940-1



MODEL	VOLTAJ (V)	FREKANS (Hz)	GÜÇ (kW)	DEVİR (d/dk)	DEBİ (m³/h)	SES SEVİYESİ (dB(A))	FİYAT (€/Adet)
HASP 280	380	50	0,18	1.450	1.100	36	600,00 €
HASP 315	380	50	0,25	1.469	1.600	38	720,00 €
HASP 355	380	50	0,37	1.471	2.300	43	790,00 €
HASP 400	380	50	0,55	1.478	3.300	45	900,00 €
HASP 450	380	50	0,75	1.454	5.000	50	1.060,00 €
HASP 500	380	50	1,10	1.462	7.000	53	1.260,00 €
HASP 560	380	50	1,50	1.464	9.800	56	1.600,00 €
HASP 630	380	50	3,00	1.465	14.000	59	2.100,00 €
HASP 710	380	50	4,00	950	13.000	55	2.990,00 €

Değerler 0 Pa içindir

1,5 kW'a Kadar Monofaze Motor Takılabilir. Monofaze Motorlu İstenirse Mevcut Fiyata %20 Fark Uygulanır.

TEKNİK RESİM

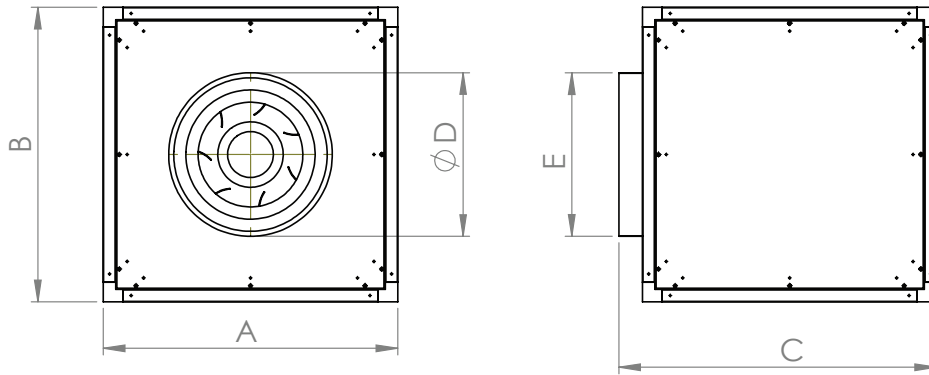

MODEL	A (mm)	B (mm)	C (mm)	D (mm)	E (mm)
HASP 280	450	450	520	280	250
HASP 315	500	500	570	315	300
HASP 355	500	500	570	355	300
HASP 400	600	600	600	400	350
HASP 450	700	700	770	450	400
HASP 500	800	800	870	500	450
HASP 560	900	900	970	560	500
HASP 630	1000	1000	1070	630	600
HASP 710	1100	1100	1170	710	650

PERFORMANS EĞRİLERİ

HASP 280

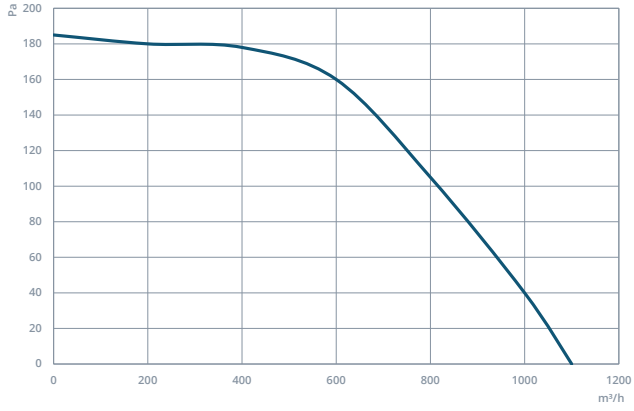

HASP 315

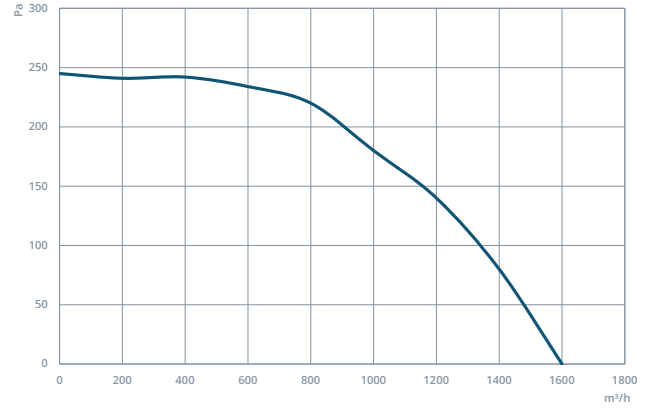

HASP 355

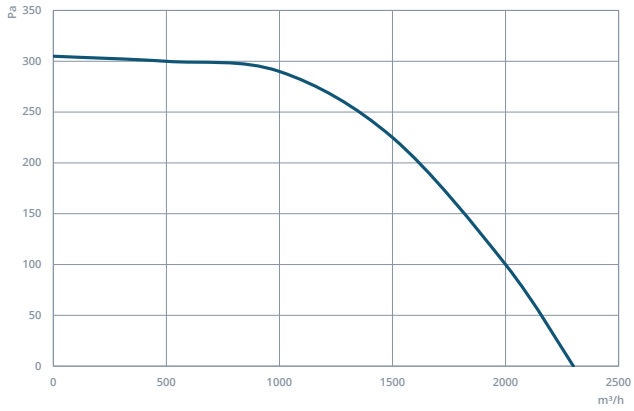

HASP 400

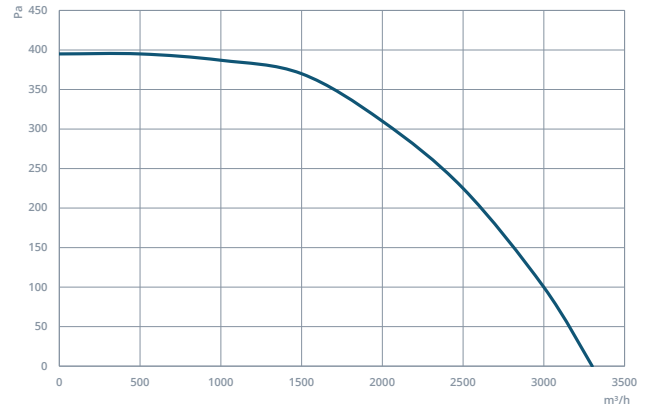

HASP 450

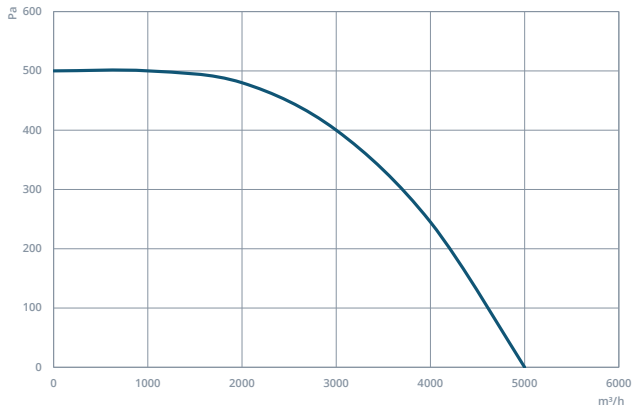

HASP 500

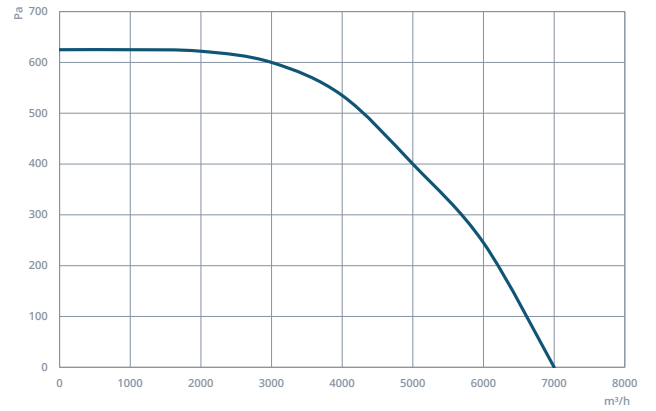

HASP 560

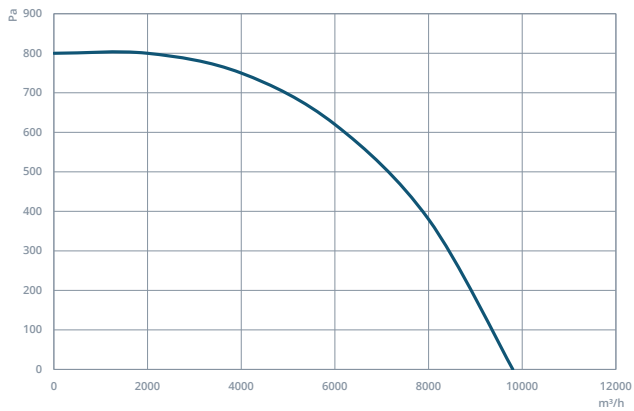

HASP 630

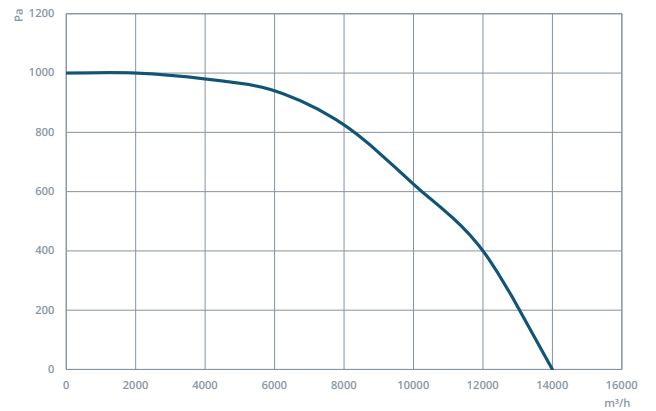

PERFORMANS EĞRİLERİ

HASP 710

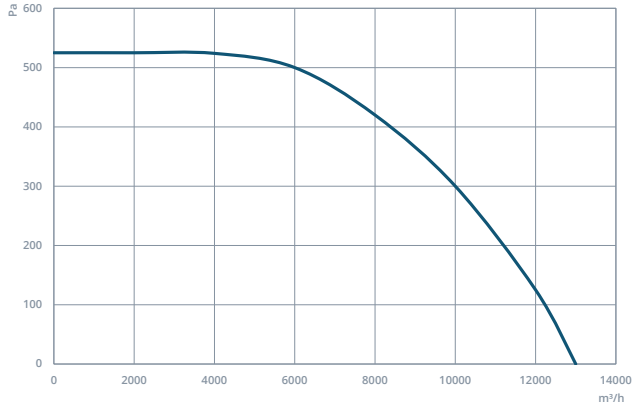

K VERİM
ÇEVRE
O TEKNOLOJİ

L

A HAVA
LAN
Y DIRMA

► EC-CRAD - EC Motorlu Çatı Tipi Yatay Atışlı Radyal Fan

EC-CRAD fanlar çatıya montajın gerekli olduğu havalandırma projelerinde kolay montajı, uzun ömürlü motoru ve verimli pervanesi ile kolay bir çözüm sunmaktadır. EC motoru sayesinde yüksek verimle çalışır ve yüksek hassasiyet ile kontrol edilebilirler. Otomasyon paneli ile çalıştırılması gereklidir.



MOTOR YALITIM SINIFI	F SINIFI
MOTOR KORUMA SINIFI	IP 54
MOTOR VERİM SINIFI	>IE4
MOTOR TİPİ	DIŞTAN ROTORLU MOTOR
MOTOR MARKASI	-
GÖVDE MALZEMESİ	GALVANİZE SAC
GÖVDE KAPLAMASI	ELEKTRO-STATİK TOZ BOYA
PERVANE MALZEMESİ	ALÜMİNYUM
GÖREV DÖNGÜSÜ	IEC Duty Cycle-S1
ÇALIŞMA SICAKLIĞI	-20 - +50 °C
STANDARTLAR	IEC-60335-2-80, ISO 1940-1



MODEL	VOLTAJ (V)	FREKANS (Hz)	GÜÇ (W)	DEVİR (d/dk)	DEBİ (m³/h)	SES SEVİYESİ (dB(A))	FİYAT (€/Adet)
EC-CRAD 190	230	50/60	161	4.555	974	50	483,00 €
EC-CRAD 225	230	50/60	168	3.540	1.270	50	707,00 €
EC-CRAD 250	230	50/60	302	3.400	1.810	55	980,00 €
EC-CRAD 315	230	50/60	307	2.180	3.250	56	1.144,00 €
EC-CRAD 355	380	50/60	770	2.400	5.590	58	1.918,00 €
EC-CRAD 400	380	50/60	2.384	2.680	10.220	60	3.139,00 €

Değerler 0 Pa içindir
Basınç Fark Kontrol Cihazı: 210€

TEKNİK RESİM

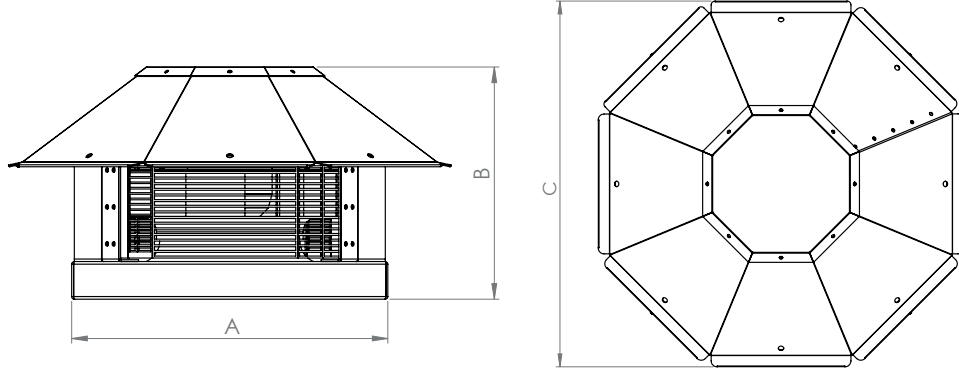

MODEL	A (mm)	B (mm)	C (mm)
EC-CRAD 190	250	220	340
EC-CRAD 225	336	247	471
EC-CRAD 250	355	252	500
EC-CRAD 315	370	256	523
EC-CRAD 355	450	337	640
EC-CRAD 400	450	367	640

PERFORMANS EĞRİLERİ

EC-CRAD 190

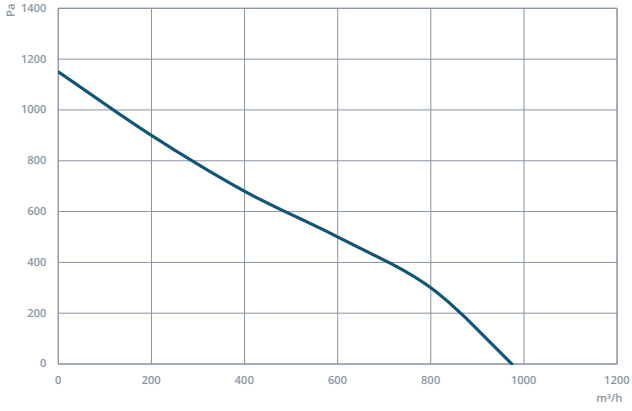

EC-CRAD 225

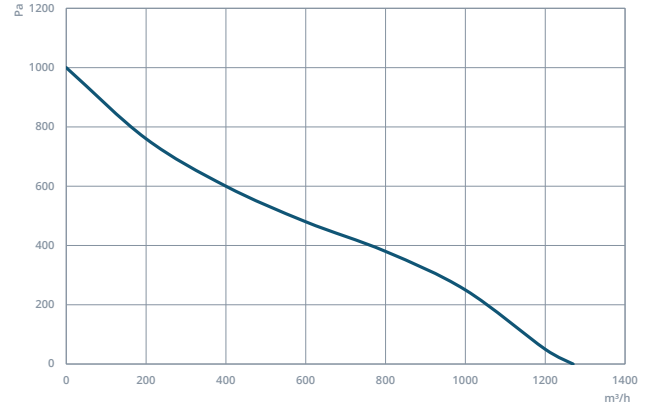

EC-CRAD 250

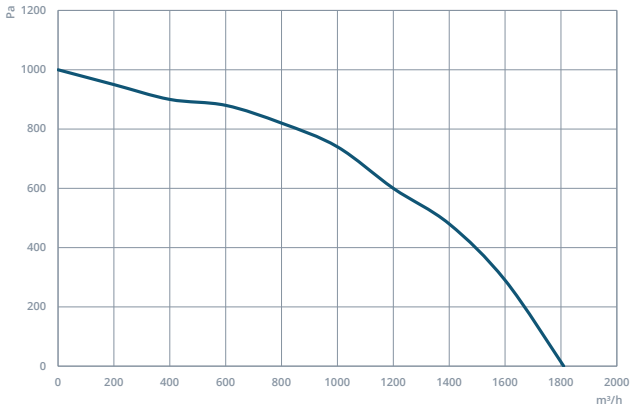

EC-CRAD 315

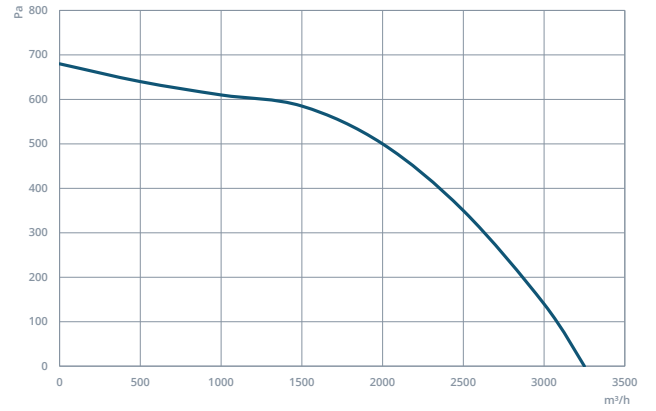

EC-CRAD 355

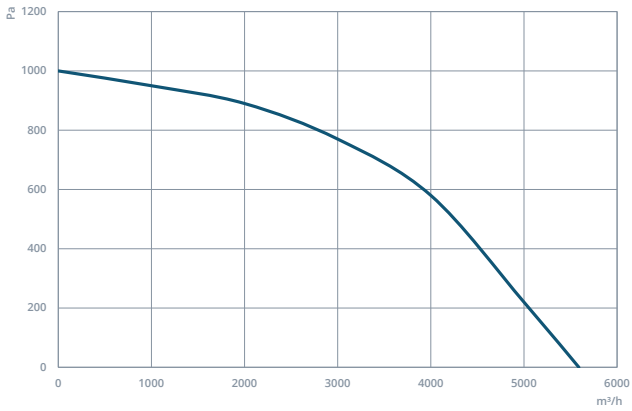

EC-CRAD 400

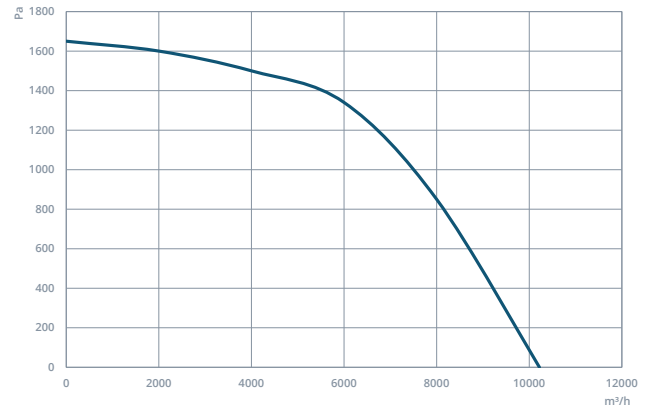

► CRAD - Çatı Tipi Yatay Atışlı Radyal Fan

CRAD fanlar çatıya montajın gerekli olduğu havalandırma projelerinde kolay montajı, uzun ömürlü motoru ve verimli pervanesi ile kolay bir çözüm sunmaktadır.



MOTOR YALITIM SINIFI	F SINIFI
MOTOR KORUMA SINIFI	IP 44
MOTOR VERİM SINIFI	-
MOTOR TİPİ	DIŞTAN ROTORLU MOTOR
MOTOR MARKASI	-
GÖVDE MALZEMESİ	GALVANİZE SAC
GÖVDE KAPLAMASI	ELEKTROSTATİK TOZ BOYA
PERVANE MALZEMESİ	ALÜMİNYUM
GÖREV DÖNGÜSÜ	IEC Duty Cycle-S1
ÇALIŞMA SICAKLIĞI	-20 - +50 °C
STANDARTLAR	IEC-60335-2-80, ISO 1940-1



MODEL	VOLTAJ (V)	FREKANS (Hz)	GÜÇ (W)	HIZ ANAHTARI MODELİ	DEVİR (d/dk)	DEBİ (m³/h)	SES SEVİYESİ (dB(A))	FİYAT (€/Adet)
CRAD 190	230	50	90	KHA 2,5 A	2.600	520	50	122,00 €
CRAD 225	230	50	104	KHA 2,5 A	2.675	950	50	141,00 €
CRAD 250	230	50	130	KHA 2,5 A	2.685	1.150	55	160,00 €
CRAD 280	230	50	180	KHA 2,5 A	2.615	2.000	60	224,00 €
CRAD 355	230	50	185	KHA 2,5 A	1.365	2.350	52	381,00 €
CRAD 400	230	50	380	KHA 2,5 A	1.365	3.400	55	509,00 €
CRAD 450	230	50	690	KHA 2,5 A	1.365	4.900	60	640,00 €
CRAD 500	230-380	50	1.080	KHA 5 A - 1,10 KW	1.365	7.000	63	841,00 €
CRAD 560	380	50	1.670	2,20 kW	1.365	9.300	70	1.060,00 €

Değerler 0 Pa içindir

HIZ ANAHTARI VE FREKANS KONVERTÖRÜ CİHAZ FİYATLARINA DAHİL DEĞİLDİR.

TEKNİK RESİM

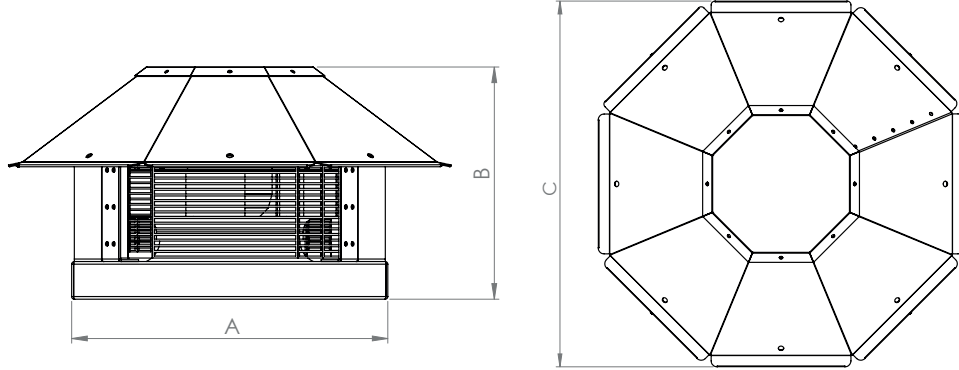

MODEL	A (mm)	B (mm)	C (mm)
CRAD 190	250	220	340
CRAD 225	336	247	471
CRAD 250	355	252	500
CRAD 280	370	256	523
CRAD 355	450	337	640
CRAD 400	450	367	640
CRAD 450	550	444	820
CRAD 500	600	500	860
CRAD 560	630	510	920

PERFORMANS EĞRİLERİ

CRAD 190

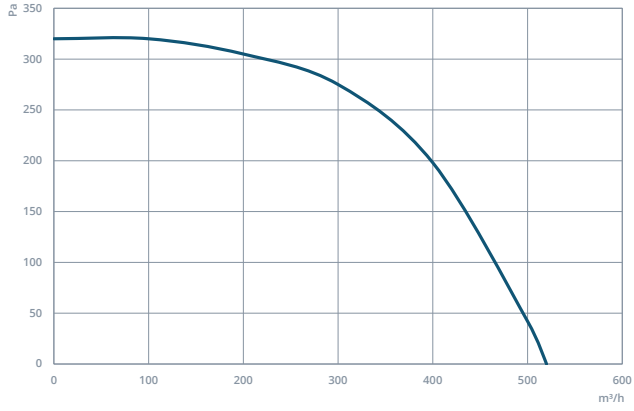

CRAD 225

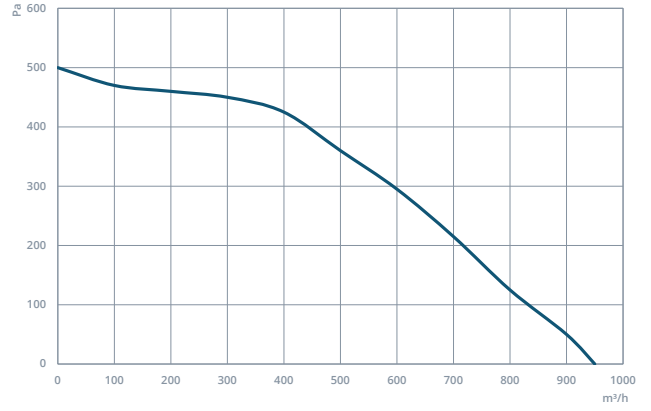

CRAD 250

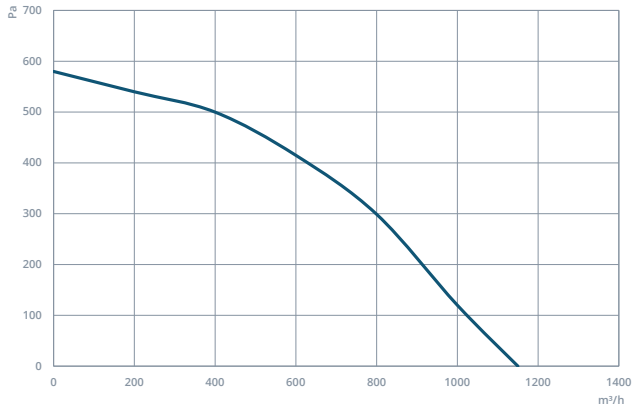

CRAD 280

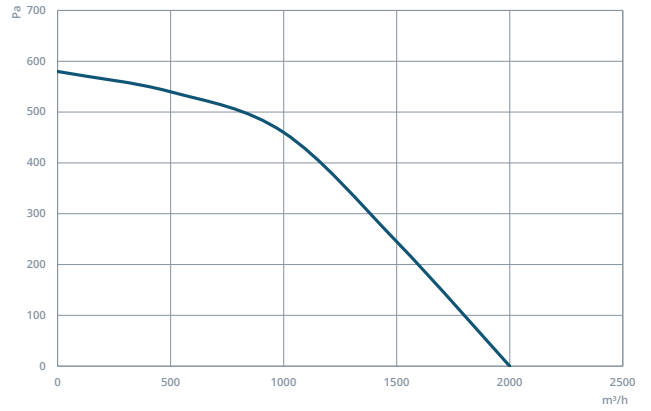

CRAD 355

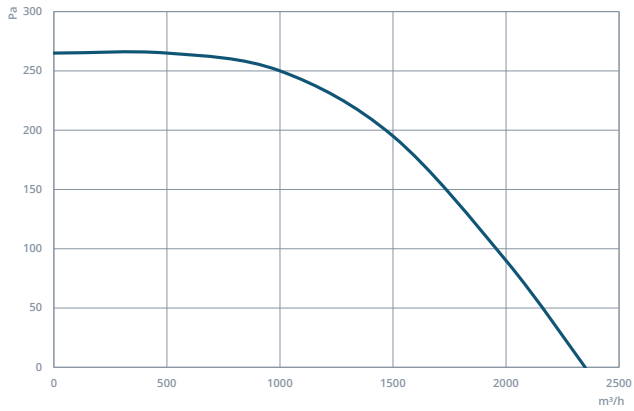

CRAD 400

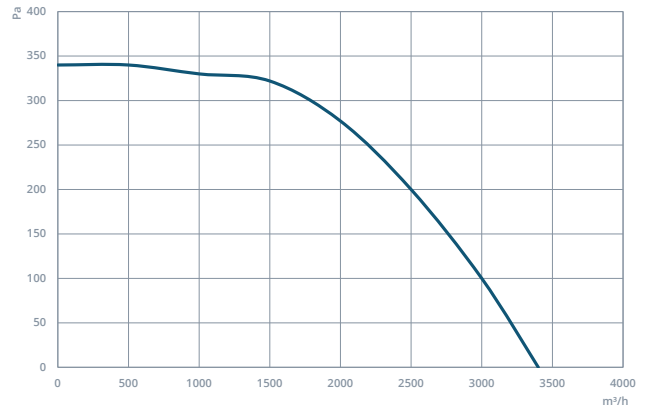

CRAD 450

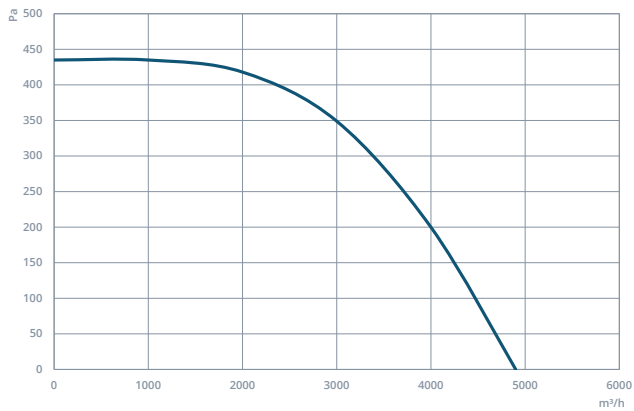

CRAD 500

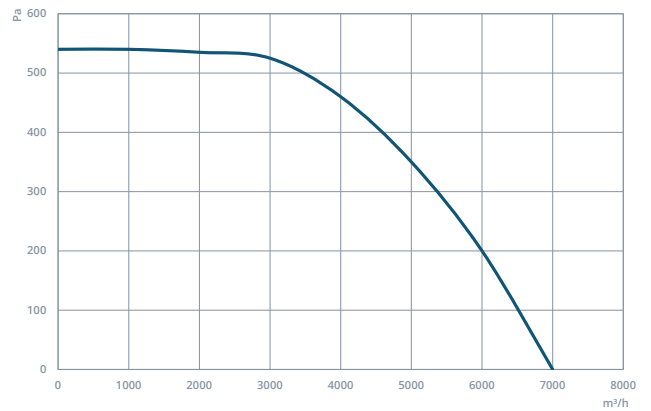

PERFORMANS EĞRİLERİ

CRAD 560

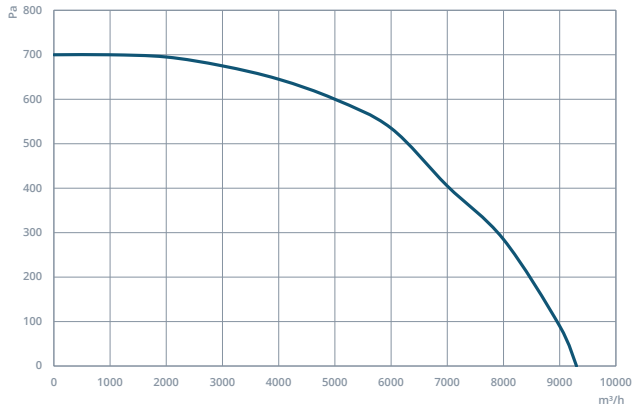

K MONTAJ
K ÇATI
O ATIŞ

L

A HAVA
LAN
Y DIRMA

► CRADIK - Çatı Tipi Dikey Atışlı Radyal Fan

CRADIK fanlar çatıya montajın gerekli olduğu havalandırma projelerinde kolay montajı, uzun ömürlü motoru ve verimli pervanesi ile kolay bir çözüm sunmaktadır. Dikey atışı sayesinde etrafının kapalı olmasından etkilenmez.



MOTOR YALITIM SINIFI	F SINIFI
MOTOR KORUMA SINIFI	IP 44
MOTOR VERİM SINIFI	-
MOTOR TİPİ	DIŞTAN ROTORLU MOTOR
MOTOR MARKASI	-
GÖVDE MALZEMESİ	GALVANİZE SAC
GÖVDE KAPLAMASI	ELEKTROSTATİK TOZ BOYA
PERVANE MALZEMESİ	ALÜMİNYUM
GÖREV DÖNGÜSÜ	IEC Duty Cycle-S1
ÇALIŞMA SICAKLIĞI	-20 - +50 °C
STANDARTLAR	IEC-60335-2-80, ISO 1940-1



MODEL	VOLTAJ (V)	FREKANS (Hz)	GÜÇ (W)	HIZ ANAHTARI MODELİ	DEVİR (d/dk)	DEBİ (m³/h)	SES SEVİYESİ (dB(A))	FİYAT (€/Adet)
CRADIK 190	230	50	90	KHA 2,5 A	2.600	520	54	180,00 €
CRADIK 225	230	50	104	KHA 2,5 A	2.675	950	55	190,00 €
CRADIK 250	230	50	130	KHA 2,5 A	2.685	1.150	58	235,00 €
CRADIK 280	230	50	180	KHA 2,5 A	2.615	2.000	60	263,00 €
CRADIK 355	230	50	185	KHA 2,5 A	1.365	2.350	55	443,00 €
CRADIK 400	230	50	380	KHA 2,5 A	1.365	3.400	58	560,00 €
CRADIK 450	230	50	690	KHA 2,5 A	1.365	4.900	62	740,00 €
CRADIK 500	230-380	50	1.080	KHA 5 A - 1,10 kW	1.365	7.000	65	947,00 €
CRADIK 560	380	50	1.670	2,20 kW	1.365	9.300	70	1.739,00 €

Değerler 0 Pa içindir

HIZ ANAHTARI VE FREKANS KONVERTÖRÜ CİHAZ FİYATLARINA DAHİL DEĞİLDİR.

TEKNİK RESİM

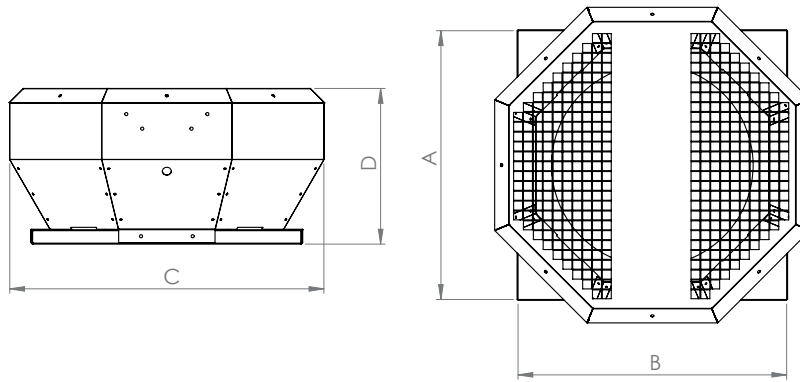

MODEL	A (mm)	B (mm)	C (mm)	D (mm)
CRADIK 190	340	340	442	192
CRADIK 225	420	420	502	228
CRADIK 250	435	435	532	242
CRADIK 280	450	450	552	256
CRADIK 355	550	550	652	317
CRADIK 400	600	600	702	348
CRADIK 450	650	650	752	356
CRADIK 500	700	700	802	412
CRADIK 560	800	800	902	427

PERFORMANS EĞRİLERİ

CRADIK 190

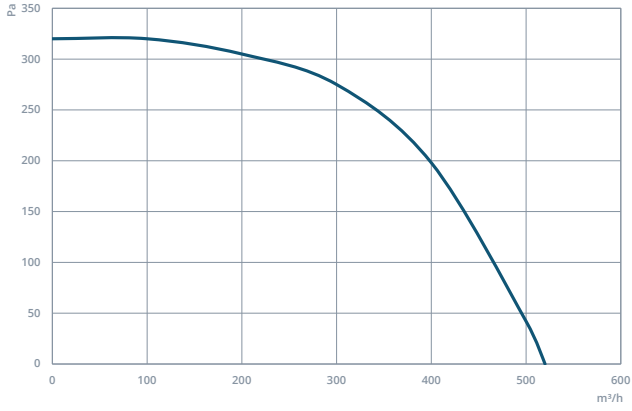

CRADIK 225

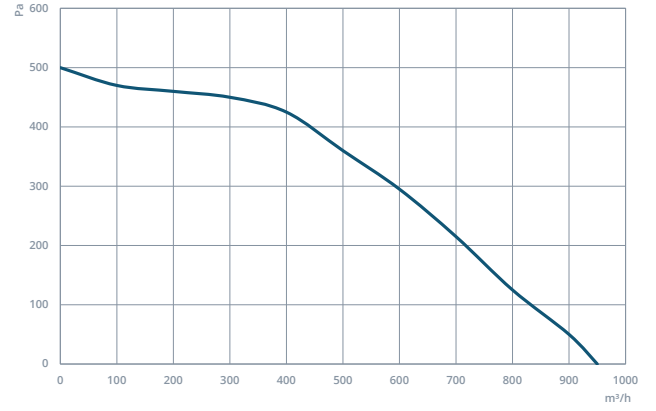

CRADIK 250

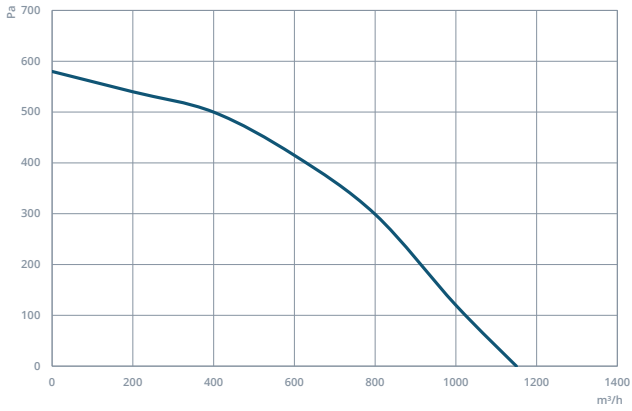

CRADIK 280

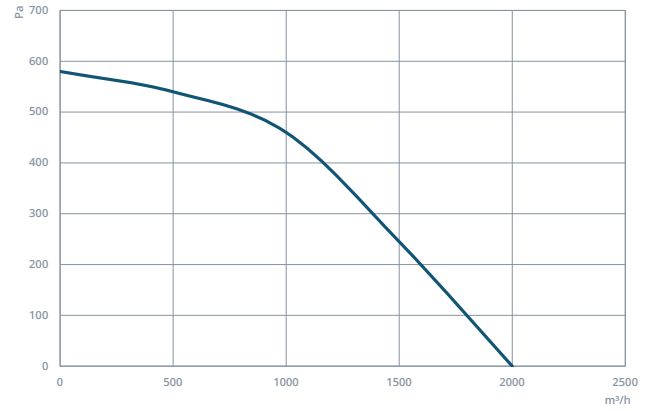

CRADIK 355

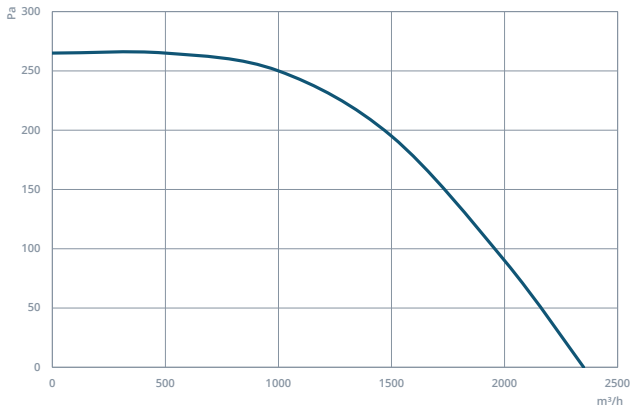

CRADIK 400

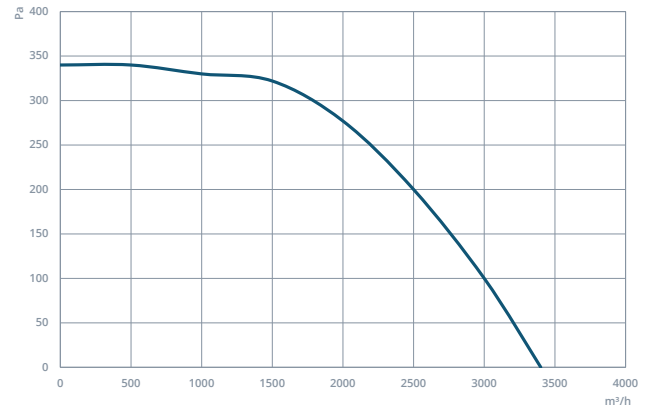

CRADIK 450

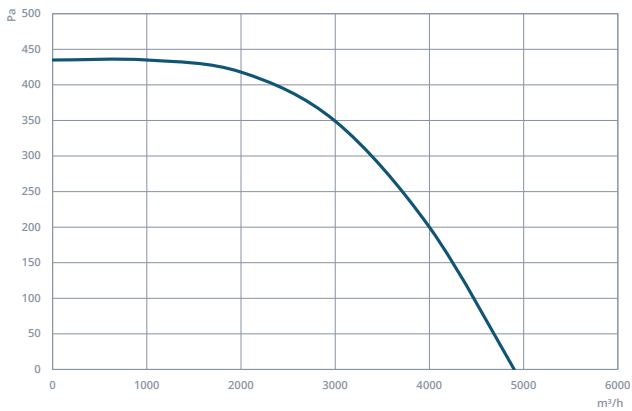

CRADIK 500

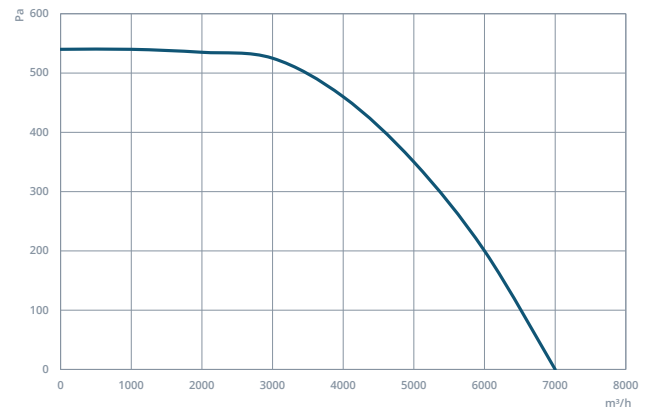

PERFORMANS EĞRİLERİ

CRADIK 560

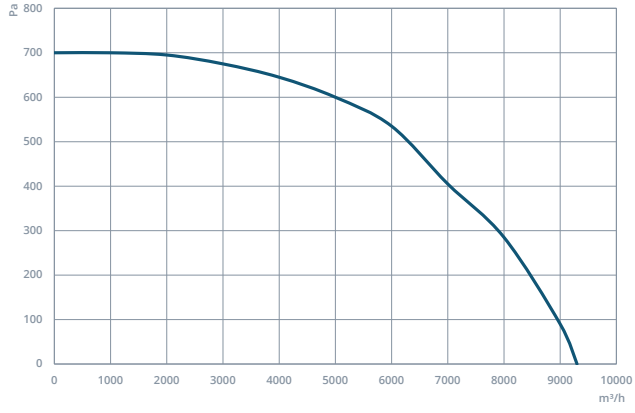

K MONTAJ
O ÇATI
BAKIM

L
A HAVA
Y LAN
DIRMA

► MRAD - Dıştan Motorlu Çatı Tipi Yatay Atışlı Monofaze Radyal Fan

MRAD fanlar motorun hava akımı dışında olması sayesinde havanın içinde bulunan ve motora zarar verebilecek toz ve yağ gibi emenlerden motoru korur ve sürekli havalandırma sağlar. Monofaze motoru sayesinde 230 V elektrik ile çalışabilir



MOTOR YALITIM SINIFI	F SINIFI
MOTOR KORUMA SINIFI	IP 44
MOTOR VERİM SINIFI	-
MOTOR TİPİ	DIŞTAN ROTORLU MOTOR
MOTOR MARKASI	-
GÖVDE MALZEMESİ	GALVANİZE SAC
GÖVDE KAPLAMASI	ELEKTROSTATİK TOZ BOYA
PERVANE MALZEMESİ	ALÜMİNYUM
GÖREV DÖNGÜSÜ	IEC Duty Cycle-S1
ÇALIŞMA SICAKLIĞI	-20 - +50 °C
STANDARTLAR	IEC-60335-2-80, ISO 1940-1



MODEL	VOLTAJ (V)	FREKANS (Hz)	GÜÇ (W)	HIZ ANAHTARI MODELİ	DEVİR (d/dk)	DEBİ (m³/h)	SES SEVİYESİ (dB(A))	FİYAT (€/Adet)
MRAD 315	230	50	190	KHA 2,5 A	2.700	1.930	56	246,00 €
Değerler 0 Pa içindir								
HIZ ANAHTARI CİHAZ FİYATLARINA DAHİL DEĞİLDİR.								

TEKNİK RESİM

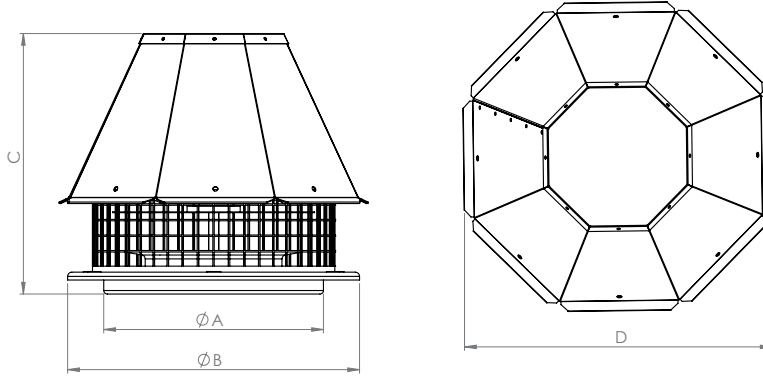

MODEL	A (mm)	B (mm)	C (mm)	D (mm)
MRAD 315	310	412	370	435

PERFORMANS EĞRİLERİ

MRAD 315

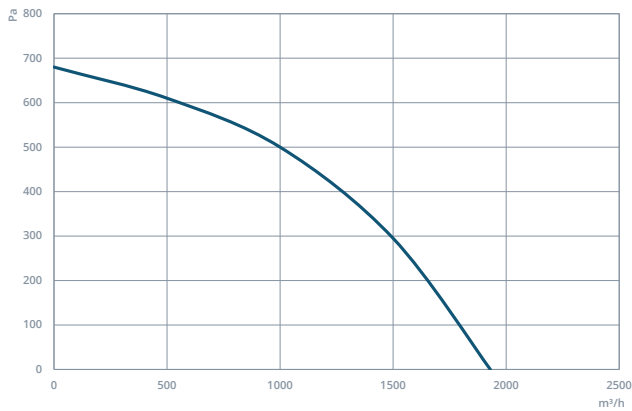

K MUTFAK
YAĞ

O BAKIM

L

A HAVA
LAN

YDIRMA

► DRAD - Dıştan Motorlu Çatı Tipi Yatay Atışlı Radyal Fan

DRAD fanlar motorun hava akımı dışında olması sayesinde havanın içinde bulunan ve motora zarar verebilecek toz ve yağ gibi etmenlerden motoru korur ve sürekli havalandırma sağlar.



MOTOR YALITIM SINIFI	F SINIFI
MOTOR KORUMA SINIFI	IP 55
MOTOR VERİM SINIFI	IE3
MOTOR TİPİ	TEFC
MOTOR MARKASI	-
GÖVDE MALZEMESİ	GALVANİZE SAC
GÖVDE KAPLAMASI	ELEKTROSTATİK TOZ BOYA
PERVANE MALZEMESİ	ALÜMİNYUM
GÖREV DÖNGÜSÜ	IEC Duty Cycle-S1
ÇALIŞMA SICAKLIĞI	-20 - +50 °C
STANDARTLAR	IEC-60335-2-80, ISO 1940-1



MODEL	VOLTAJ (V)	FREKANS (Hz)	GÜÇ (kW)	DEVİR (d/dk)	DEBİ (m³/h)	SES SEVİYESİ (dB(A))	FİYAT (€/Adet)
DRAD 280	380	50	0,18	1.450	1.100	53	370,00 €
DRAD 315	380	50	0,25	1.469	1.600	52	462,00 €
DRAD 355	380	50	0,37	1.471	2.300	55	509,00 €
DRAD 400	380	50	0,55	1.478	3.300	60	588,00 €
DRAD 450	380	50	0,75	1.454	5.000	62	699,00 €
DRAD 500	380	50	1,10	1.462	7.000	64	900,00 €
DRAD 560	380	50	1,50	1.464	9.800	66	1.120,00 €

Değerler 0 Pa içindir

1,5 kW'a Kadar Monofaze Motor Takılabilir. Monofaze Motorlu İstenirse Mevcut Fiyata %20 Fark Uygulanır.

TEKNİK RESİM

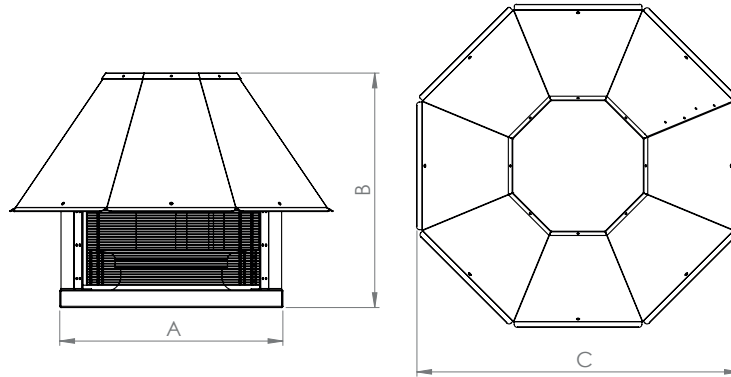

MODEL	A (mm)	B (mm)	C (mm)
DRAD 280	366	412	536
DRAD 315	400	460	580
DRAD 355	450	466	630
DRAD 400	500	526	723
DRAD 450	550	562	820
DRAD 500	600	614	900
DRAD 560	650	620	973

PERFORMANS EĞRİLERİ

DRAD 280

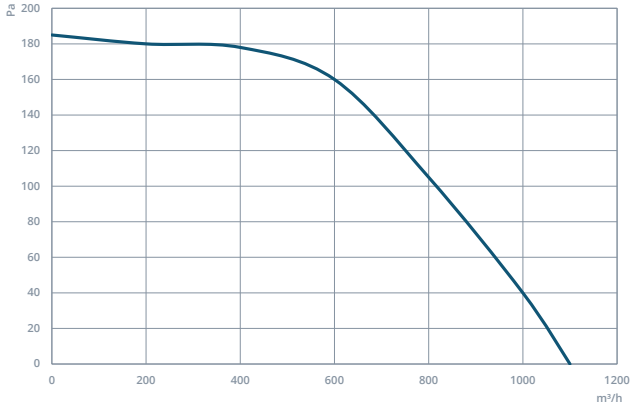

DRAD 315

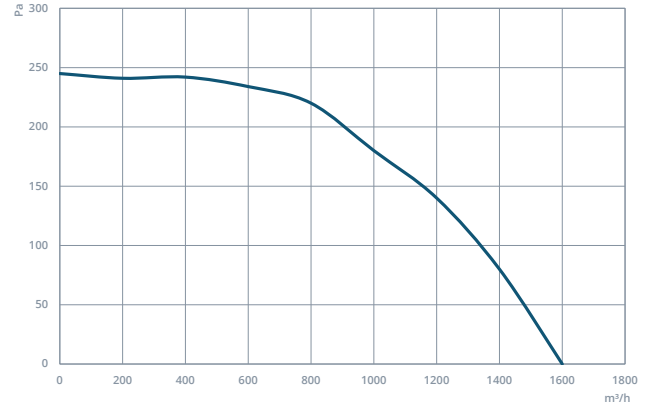

DRAD 355

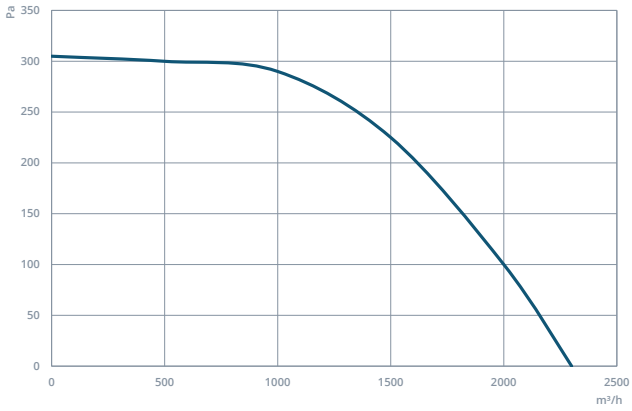

DRAD 400

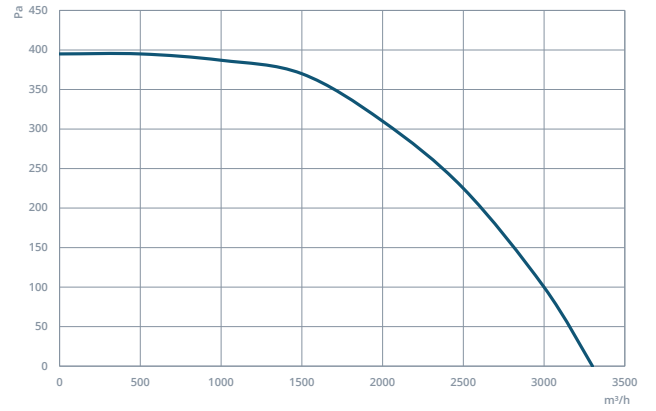

DRAD 450

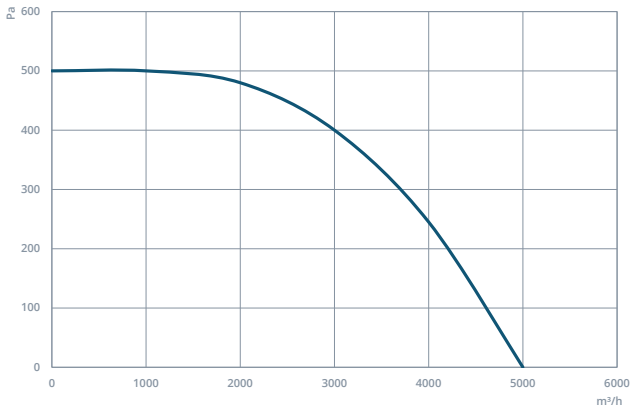

DRAD 500

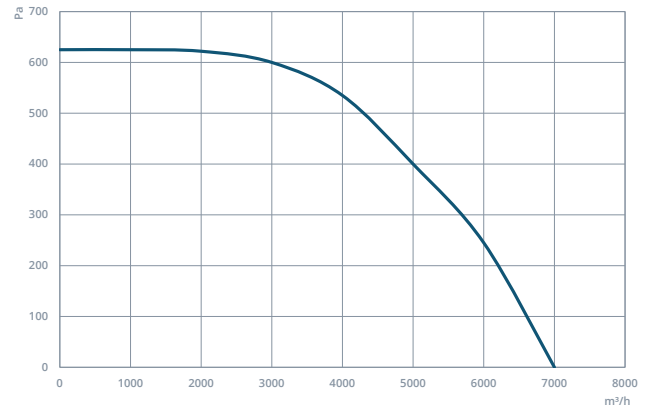

DRAD 560

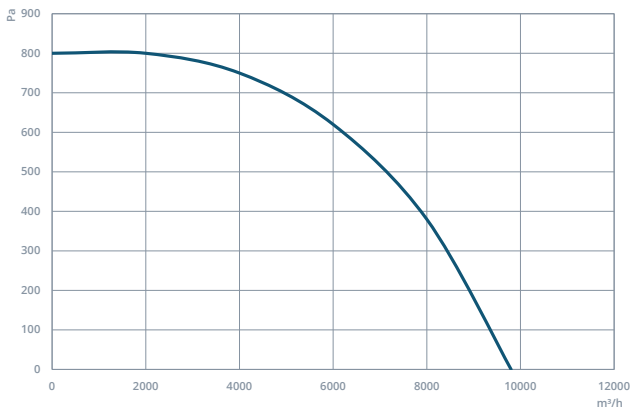

► DRADIK - Dıştan Motorlu Çatı Tipi Dikey Atışlı Radyal Fan

DRADIK fanlar motorun hava akımı dışında olması sayesinde havanın içinde bulunan ve motora zarar verebilecek toz ve yağ gibi etmenlerden motoru korur ve sürekli havalandırma sağlar. Dikey atışı sayesinde etrafının kapalı olmasından etkilenmez.



MOTOR YALITIM SINIFI	F SINIFI
MOTOR KORUMA SINIFI	IP 55
MOTOR VERİM SINIFI	IE3
MOTOR TİPİ	TEFC
MOTOR MARKASI	-
GÖVDE MALZEMESİ	GALVANİZE SAC
GÖVDE KAPLAMASI	ELEKTROSTATİK TOZ BOYA
PERVANE MALZEMESİ	ALÜMİNYUM
GÖREV DÖNGÜSÜ	IEC Duty Cycle-S1
ÇALIŞMA SICAKLIĞI	-20 - +50 °C
STANDARTLAR	IEC-60335-2-80, ISO 1940-1



MODEL	VOLTAJ (V)	FREKANS (Hz)	GÜÇ (kW)	DEVİR (d/dk)	DEBİ (m³/h)	SES SEVİYESİ (dB(A))	FİYAT (€/Adet)
DRADIK 280	380	50	0,18	1.450	1.100	63	510,00 €
DRADIK 315	380	50	0,25	1.469	1.600	64	633,00 €
DRADIK 355	380	50	0,37	1.471	2.300	58	720,00 €
DRADIK 400	380	50	0,55	1.478	3.300	60	820,00 €
DRADIK 450	380	50	0,75	1.454	5.000	62	900,00 €
DRADIK 500	380	50	1,10	1.462	7.000	64	1.340,00 €
DRADIK 560	380	50	1,50	1.464	9.800	67	1.990,00 €

Değerler 0 Pa içindir

1,5 kW'a Kadar Monofaze Motor Takılabilir. Monofaze Motorlu İstenirse Mevcut Fiyata %20 Fark Uygulanır.

TEKNİK RESİM

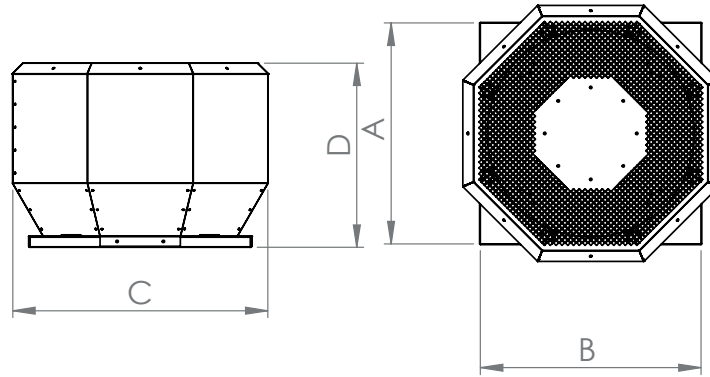

MODEL	A (mm)	B (mm)	C (mm)	C (mm)
DRADIK 280	450	450	552	405
DRADIK 315	500	500	602	440
DRADIK 355	550	550	652	478
DRADIK 400	600	600	702	517
DRADIK 450	650	650	752	543
DRADIK 500	700	700	802	610
DRADIK 560	750	750	852	642

PERFORMANS EĞRİLERİ

DRADIK 280

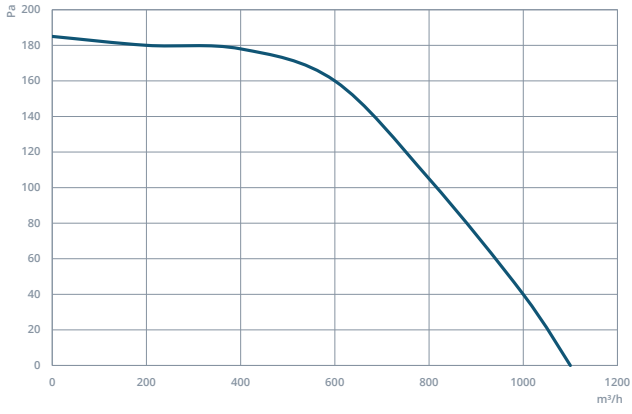

DRADIK 315

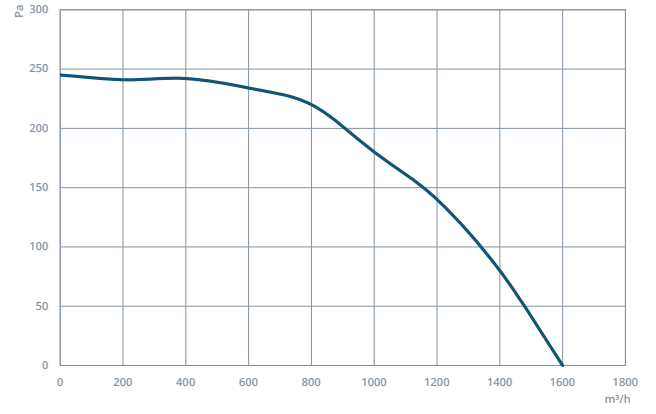

DRADIK 355

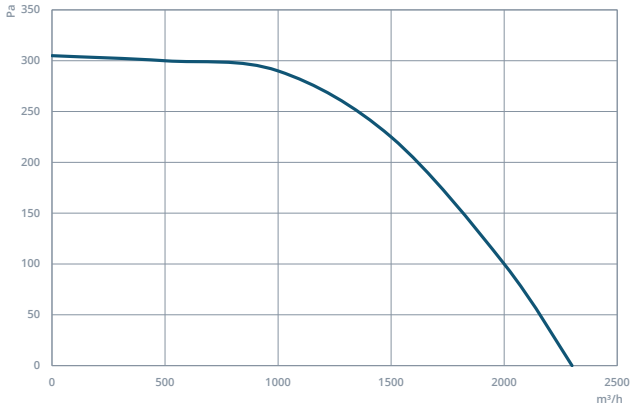

DRADIK 400

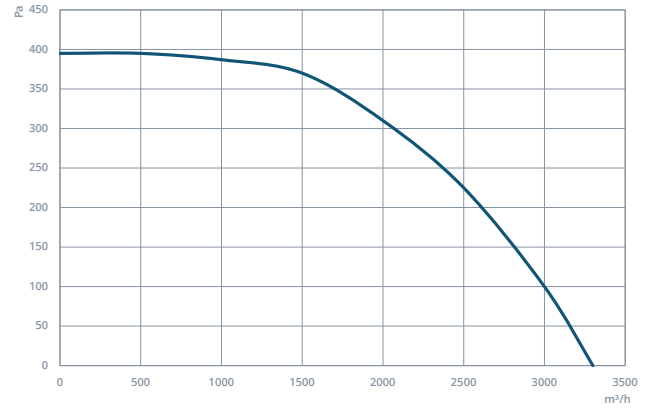

DRADIK 450

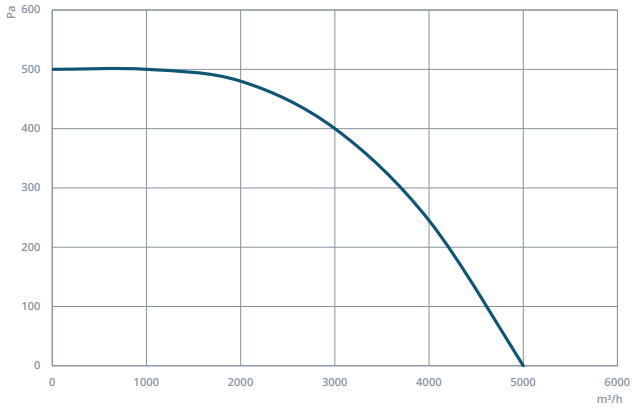

DRADIK 500

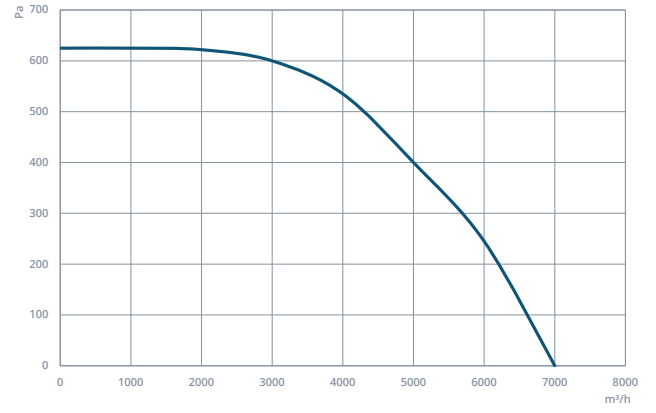

DRADIK 560

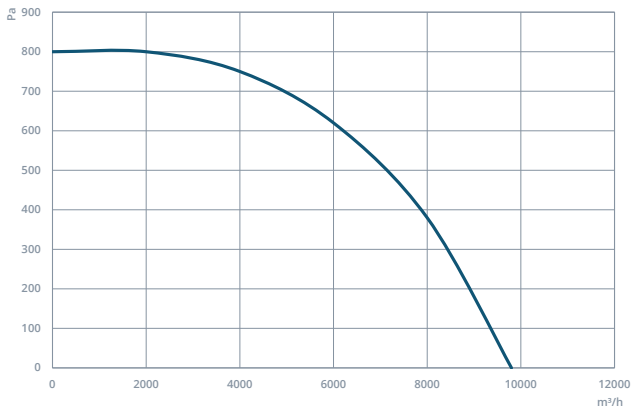

► SAL - Salyangoz Fan

SAL fanlar yüksek debili kanatları, dayanıklı gövdesi ve yönü değiştirilebilen üfleme ağız ile ihtiyaç duyduğunuz tüm havalandırma projelerinde kullanılabilir.



MOTOR YALITIM SINIFI	F SINIFI
MOTOR KORUMA SINIFI	IP 55
MOTOR VERİM SINIFI	IE3
MOTOR TİPİ	TEFC
MOTOR MARKASI	-
GÖVDE MALZEMESİ	GALVANİZE SAC
GÖVDE KAPLAMASI	ELEKTROSTATİK TOZ BOYA
PERVANE MALZEMESİ	ALÜMİNYUM
GÖREV DÖNGÜSÜ	IEC Duty Cycle-S1
ÇALIŞMA SICAKLIĞI	-20 - +50 °C
STANDARTLAR	IEC-60335-2-80, ISO 1940-1



MODEL	VOLTAJ (V)	FREKANS (Hz)	GÜÇ (kW)	DEVİR (d/dk)	DEBİ (m³/h)	SES SEVİYESİ (dB(A))	FİYAT (€/Adet)
SAL 280	380	50	0,18	1.450	1.100	36	512,00 €
SAL 315	380	50	0,25	1.469	1.600	37	528,00 €
SAL 355	380	50	0,37	1.471	2.300	42	655,00 €
SAL 400	380	50	0,55	1.478	3.300	45	920,00 €
SAL 450	380	50	0,75	1.454	5.000	47	1.000,00 €
SAL 500	380	50	1,10	1.462	7.000	49	1.200,00 €
SAL 560	380	50	1,50	1.464	9.800	51	1.400,00 €
SAL 630	380	50	3,00	1.465	14.000	54	1.819,00 €
SAL 710	380	50	4,00	950	13.000	56	2.325,00 €

Değerler 0 Pa içindir

1,5 kW'a Kadar Monofaze Motor Takılabilir. Monofaze Motorlu İstenirse Mevcut Fiyata %20 Fark Uygulanır.

TEKNİK RESİM

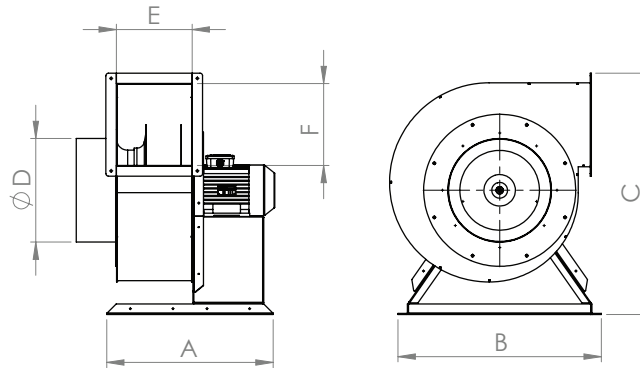

MODEL	A (mm)	B (mm)	C (mm)	D (mm)	E (mm)	F (mm)
SAL 280	380	400	600	180	140	250
SAL 315	400	420	660	200	160	280
SAL 355	385	410	720	250	170	300
SAL 400	420	420	750	245	200	320
SAL 450	445	445	820	300	226	350
SAL 500	500	485	850	350	250	370
SAL 560	620	712	1020	400	300	450
SAL 630	660	735	1100	500	345	500
SAL 710	750	760	1210	550	390	520

PERFORMANS EĞRİLERİ

SAL 280

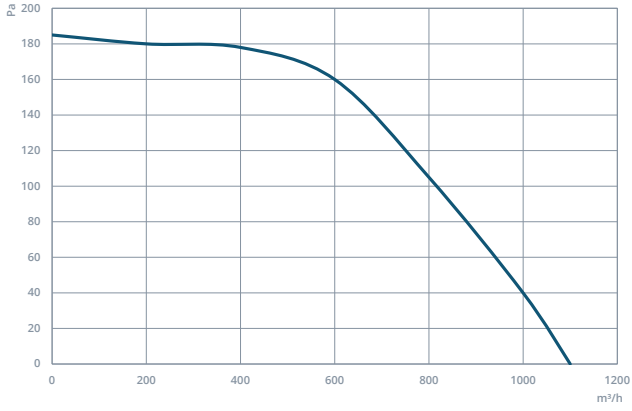

SAL 315

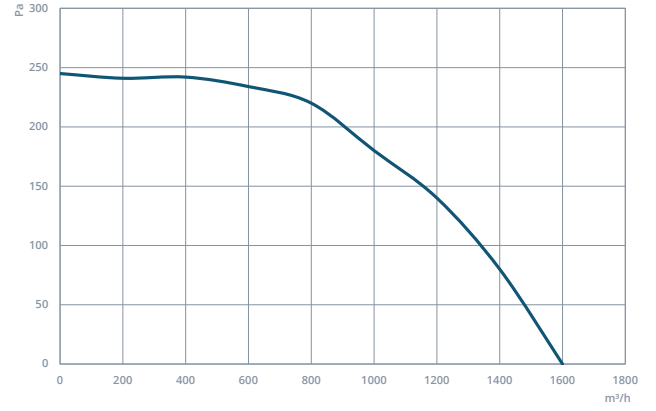

SAL 355

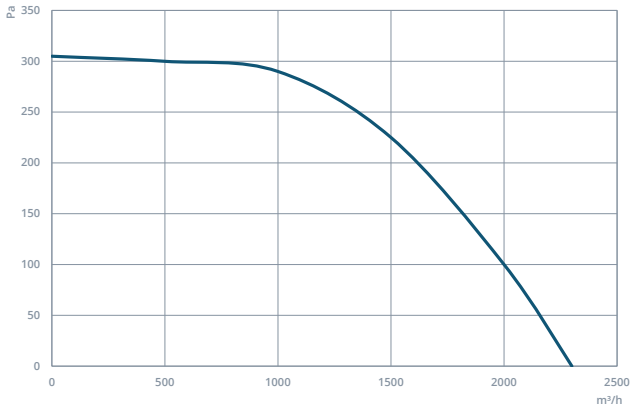

SAL 400

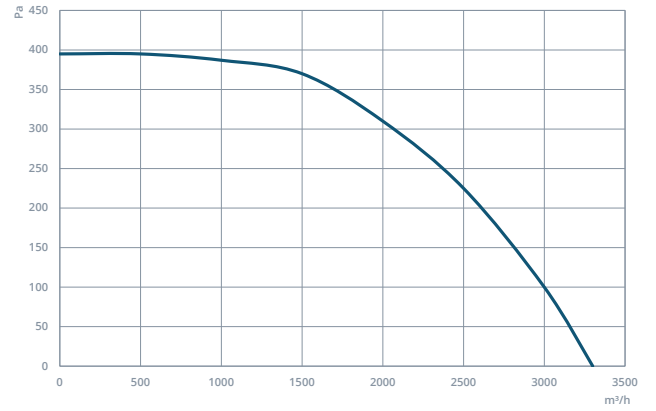

SAL 450

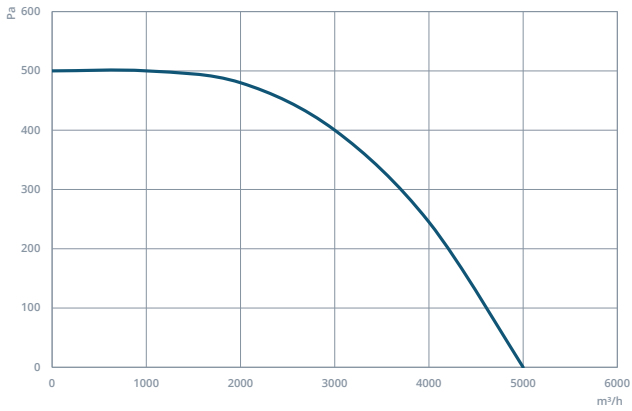

SAL 500

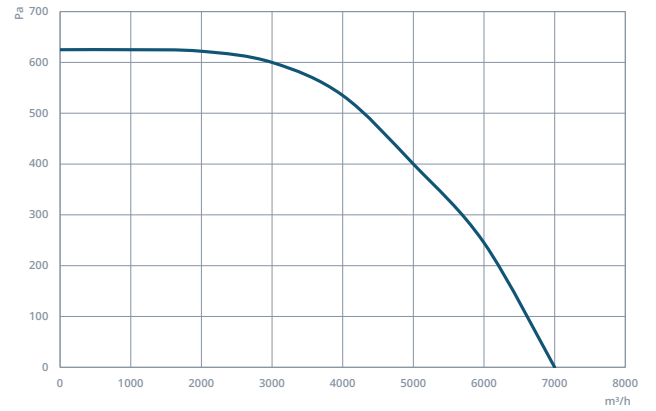

SAL 560

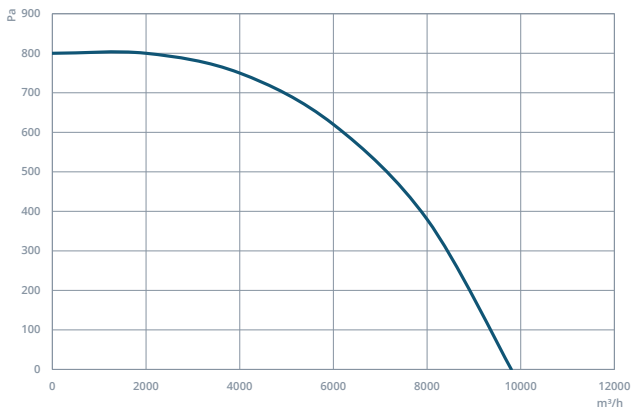

SAL 630

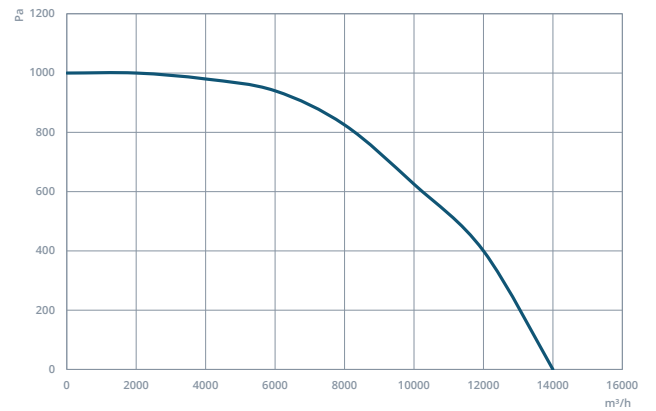

PERFORMANS EĞRİLERİ

SAL 710

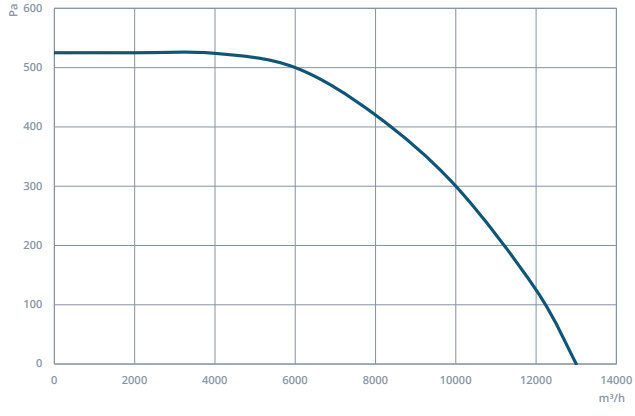

K ISINMA
K AZAN
O BAKIM

L

A HAVA
L AN
Y DIRMA

► KAZ - Alüminyum Gövdeli Salyangoz Fan

KAZ fanlar alüminyum gövdeleri, sık kanatlı pervaneleri ve küçük boyutları ile kazan fanı olarak kullanılabilir. BAXI fana akuple edilerek motoru soğutarak fanın yüksek sıcaklıkta sürekli çalışmasını sağlar.



MOTOR YALITIM SINIFI	F SINIFI
MOTOR KORUMA SINIFI	IP 44
MOTOR VERİM SINIFI	-
MOTOR TİPİ	DIŞTAN ROTORLU MOTOR
MOTOR MARKASI	-
GÖVDE MALZEMESİ	ALÜMİNYUM
GÖVDE KAPLAMASI	-
PERVANE MALZEMESİ	GALVANİZE SAC
GÖREV DÖNGÜSÜ	IEC Duty Cycle-S1
ÇALIŞMA SICAKLIĞI	-20 - +50 °C
STANDARTLAR	IEC-60335-2-80, ISO 1940-1



MODEL	VOLTAJ (V)	FREKANS (Hz)	GÜÇ (W)	HIZ ANAHTARI MODELİ	DEVİR (d/dk)	DEBİ (m³/h)	SES SEVİYESİ (dB(A))	FİYAT (€/Adet)
KAZ 120	230	50	84	KHA 2,5 A	2.450	275	45	67,00 €
KAZ 140	230	50	137	KHA 2,5 A	2.265	485	47	78,00 €
KAZ 160	230	50	193	KHA 2,5 A	2.100	600	50	88,00 €

Değerler 0 Pa içindir

HIZ ANAHTARI CİHAZ FİYATLARINA DAHİL DEĞİLDİR.

TEKNİK RESİM

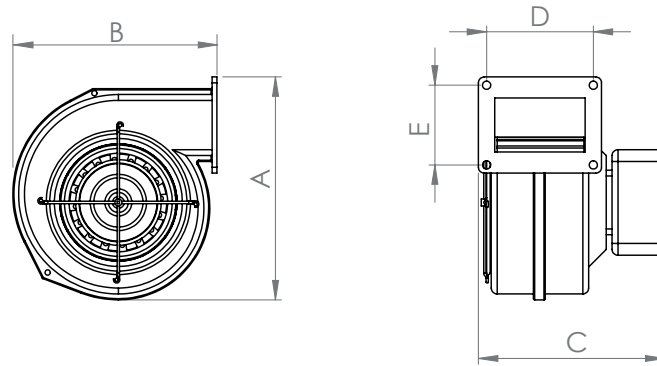

MODEL	A (mm)	B (mm)	C (mm)	D (mm)	E (mm)
KAZ 120	190	175	160	100	70
KAZ 140	260	225	145	115	105
KAZ 160	260	225	145	115	105

K VERİM
ÇEVRE
O KAZANÇ

L

A HAVA
LAN
YDIRMA

► IGK - Isı Geri Kazanım Cihazı

Isı geri kazanım cihazları verimli çapraz akışlı ısı değıştiricileri, verimli plug fanları tak-çalıştır özelliđi ile enerji verimliliđi ve çevreci projelerinizde kullanılabilir.



MOTOR YALITIM SINIFI	F SINIFI
MOTOR KORUMA SINIFI	IP 44
MOTOR VERİM SINIFI	-
MOTOR TİPİ	DIŐTAN ROTORLU MOTOR
MOTOR MARKASI	-
GÖVDE MALZEMESİ	GALVANİZE SAC
GÖVDE KAPLAMASI	YOK
PERVANE MALZEMESİ	ALÜMİNYUM
GÖREV DÖNGÜSÜ	IEC Duty Cycle-S1
ÇALIŐMA SICAKLIĐI	-20 - +50 °C
STANDARTLAR	IEC-60335-2-80, ISO 1940-1



MODEL	VOLTAJ (V)	FREKANS (Hz)	GÜÇ (W)	DEVİR (d/dk)	DEBİ (m³/h)	SES SEVİYESİ (dB(A))	FİYAT (€/Adet)
IGK 10	230	50	250	2.668	1.000	50	1.019,00 €
IGK 20	230	50	400	2.396	2.000	48	1.259,00 €
IGK 30	230	50	780	1.465	3.000	49	1.996,00 €
IGK 40	230	50	1.300	1.410	4.000	51	2.253,00 €
IGK 50	230	50	1.700	1.380	6.000	58	3.016,00 €

Deđerler 0 Pa içindir.
HIZ ANAHTARI CİHAZ FİYATLARINA DAHİLDİR.

OPSİYONLAR



KUMANDA		ISITICI	
ÖLÇÜ	FİYAT	ÖLÇÜ	FİYAT
10	207,00 €	3 kW	358,00 €
20	207,00 €	6 kW	462,00 €
30	207,00 €	9 kW	668,00 €
40	207,00 €	12 kW	787,00 €
50	207,00 €	15 kW	993,00 €

ELEKTRİKLİ ISITICI KUMANDA PANELİ OLMADAN KULLANILAMAZ.

TEKNİK RESİM

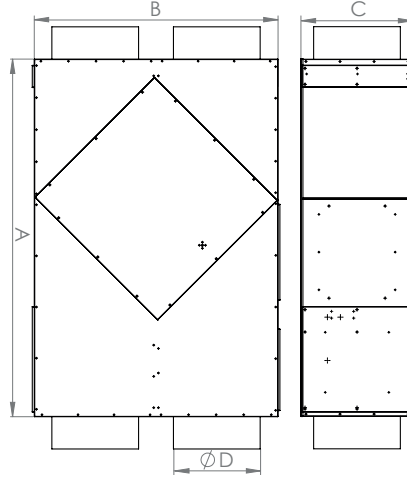

MODEL	A (mm)	B (mm)	C (mm)	D (mm)
IGK 10	967	760	320	250
IGK 20	1150	980	405	305
IGK 30	1540	1130	505	355
IGK 40	1650	1130	520	400
IGK 50	1850	1230	550	450

PERFORMANS EĞRİLERİ

IGK 10

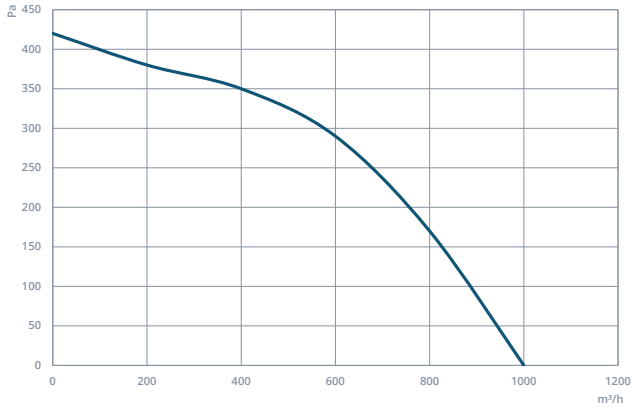

IGK 20

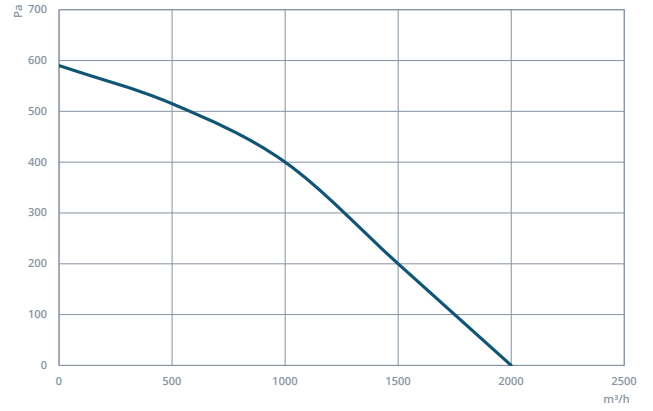

IGK 30

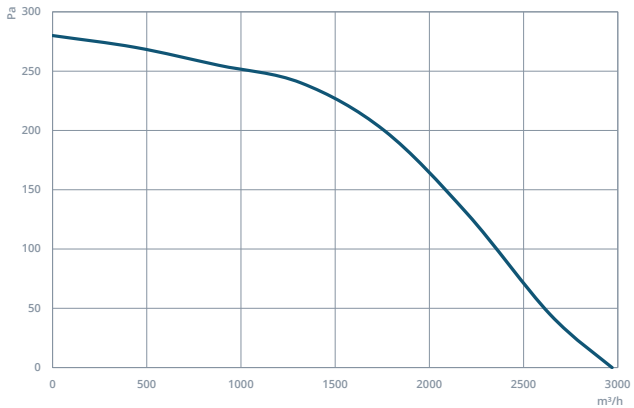

IGK 40

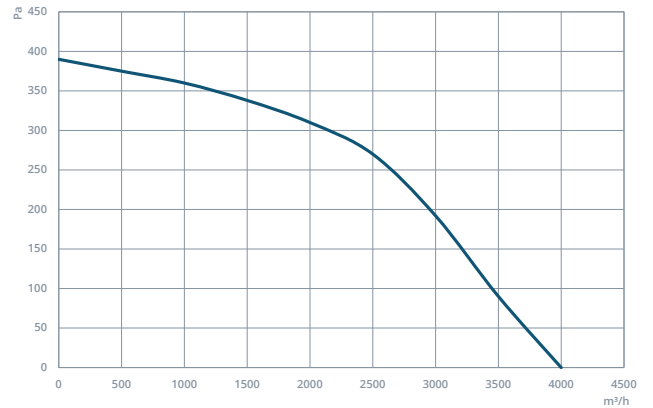

PERFORMANS EĞRİLERİ

IGK 50

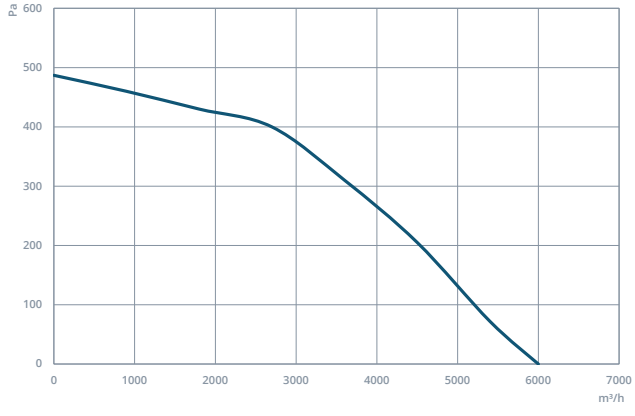

K SİĞİNAK
G GÜVENLİK
O HAVA

L

A HAVA
LAN
YDIRMA

► SHU - Sığınak Havalandırma Ünitesi

SHU'lar 3194 Sayılı İmar Kanunu yönetmeliğine tam uygun olarak tasarlanmış olup G4 toz tutucu filtre, Aktif Karbon koku tutucu filtre ve yönetmeliğin özellikle belirttiği NBC (Nükleer, Biyolojik ve Kimyasal Serpinti Tutucu) filtre içermektedir. Barış zamanında bu filtreleri kirletmemek için damper ters konuma alınıp hava sadece G4 Toz Tutucu Filtreden geçirilebilir. SHU 3E modelinde elektrik kesintisi durumunda kullanmak için tahrik kolu bulunmaktadır. Bu kol sayesinde küçük sığınaklarda elle dahi havalandırma sağlanabilir.



MOTOR YALITIM SINIFI	F SINIFI
MOTOR KORUMA SINIFI	IP 44
MOTOR VERİM SINIFI	-
MOTOR TİPİ	DIŞTAN ROTORLU MOTOR
MOTOR MARKASI	-
GÖVDE MALZEMESİ	GALVANİZE SAC
GÖVDE KAPLAMASI	YOK
PERVANE MALZEMESİ	ALÜMİNYUM
GÖREV DÖNGÜSÜ	IEC Duty Cycle-S1
ÇALIŞMA SICAKLIĞI	-20 - +50 °C
STANDARTLAR	IEC-60335-2-80, ISO 1940-1



MODEL	VOLTAJ (V)	FREKANS (Hz)	GÜÇ (W)	DEVİR (d/dk)	DEBİ (m³/h)	SES SEVİYESİ (dB(A))	FİYAT (€/Adet)
SHU 3	230	50	150	2.710	300	50	1.345,00 €
SHU 5	230	50	150	2.680	500	52	1.523,00 €
SHU 7	230	50	150	2.712	700	55	1.635,00 €
SHU 9	230	50	260	2.712	900	56	1.700,00 €
SHU 13	230	50	260	2.610	1.300	60	2.299,00 €
SHU 18	230	50	480	1.465	1.800	62	2.865,00 €
SHU 30	230	50	640	1.420	3.000	64	3.835,00 €
SHU 36	230	50	900	1.365	3.600	66	4.140,00 €
SHU 43	230	50	1.430	1.370	4.300	68	5.729,00 €
SHU 54	380	50	1.430	1.320	5.400	72	6.980,00 €
SHU 3E	230	50	150	2.710	300	50	2.493,00 €

Değerler 0 Pa içindir

OPSİYONLAR

KURŞUN SEPERATÖR		KURŞUN KAPLAMA	
MODEL	FİYAT	MODEL	FİYAT
SHU 3	77,00 €	SHU 3	150,00 €
SHU 5	107,00 €	SHU 5	203,00 €
SHU 7	107,00 €	SHU 7	203,00 €
SHU 9	107,00 €	SHU 9	203,00 €
SHU 13	173,00 €	SHU 13	285,00 €
SHU 18	249,00 €	SHU 18	383,00 €
SHU 30	285,00 €	SHU 30	449,00 €
SHU 36	285,00 €	SHU 36	449,00 €
SHU 43	285,00 €	SHU 43	449,00 €
SHU 54	509,00 €	SHU 54	807,00 €
SHU 3E	107,00 €	SHU 3E	263,00 €

TEKNİK RESİM

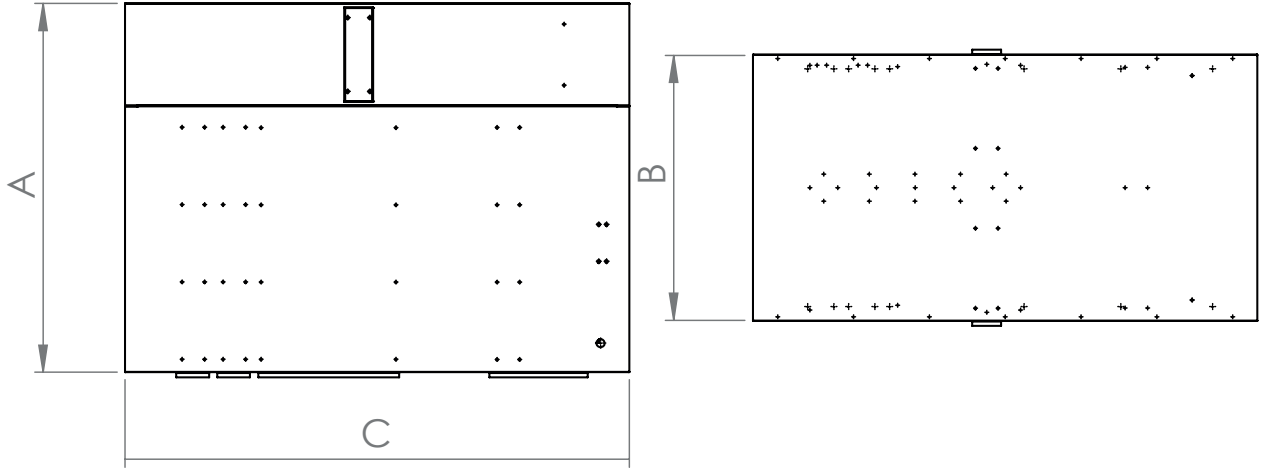

MODEL	A (mm)	B (mm)	C (mm)
SHU 3	400	300	1010
SHU 5	500	350	1250
SHU 7	500	350	1250
SHU 9	500	350	1250
SHU 13	900	350	1300
SHU 18	900	450	1280
SHU 30	900	650	1360
SHU 36	900	650	1360
SHU 43	900	650	1360
SHU 54	1300	650	1350
SHU 3E	600	400	1380

PERFORMANS EĞRİLERİ

SHU 3

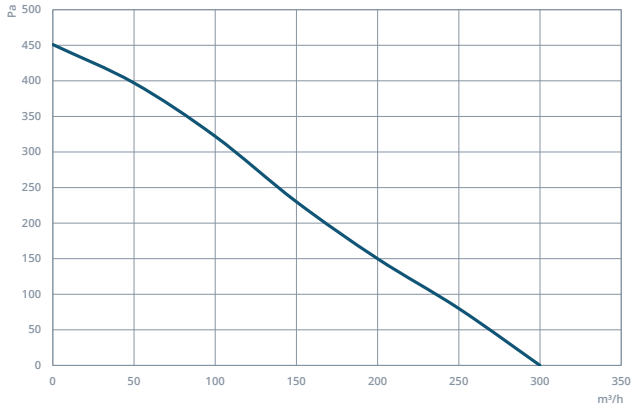

SHU 5

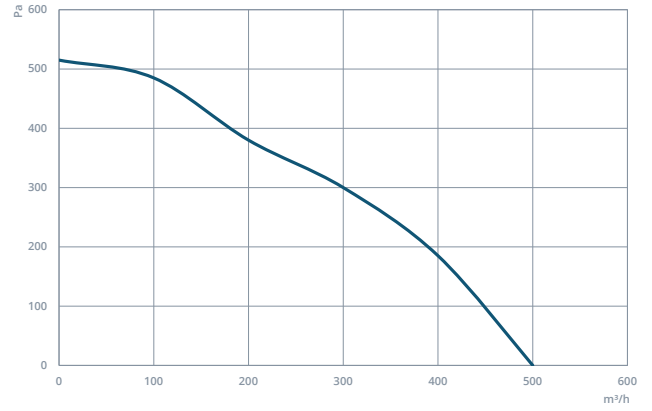

SHU 7

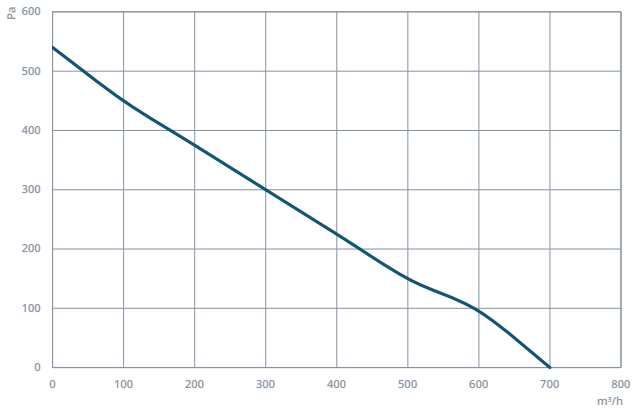

SHU 9

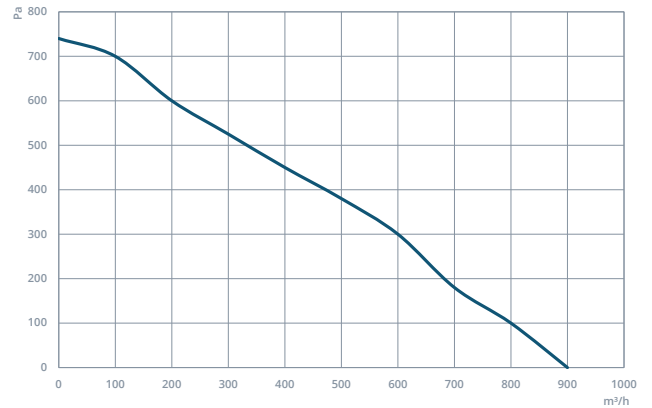

PERFORMANS EĞRİLERİ

SHU 13

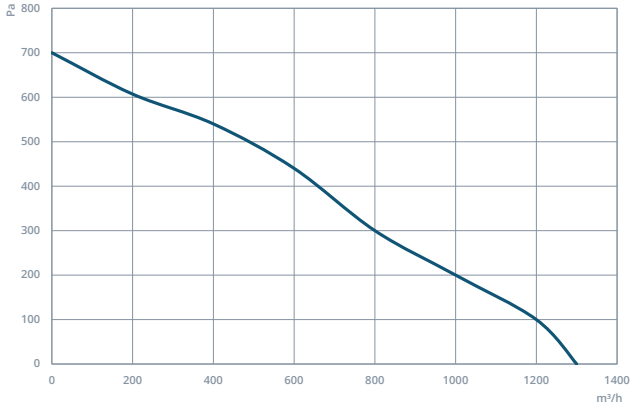

SHU 18

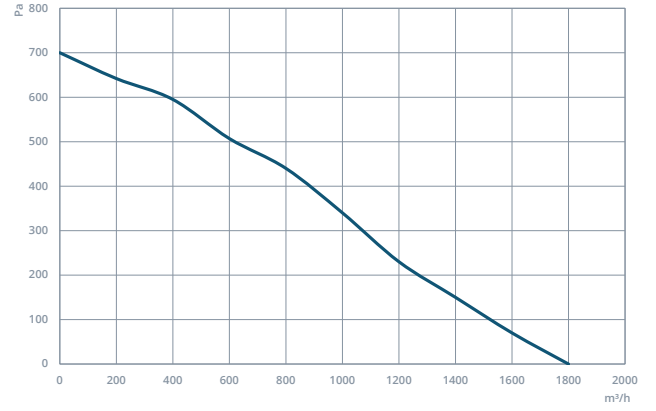

SHU 30

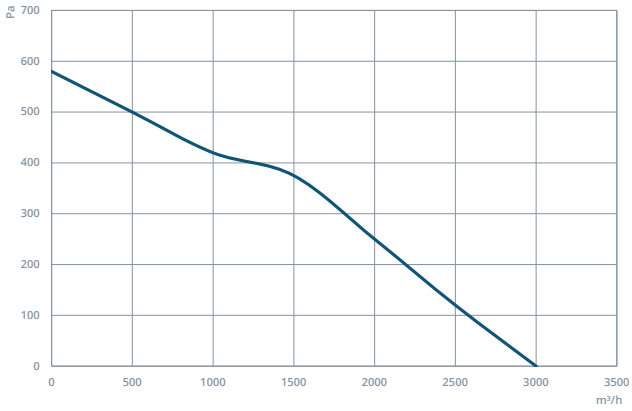

SHU 36

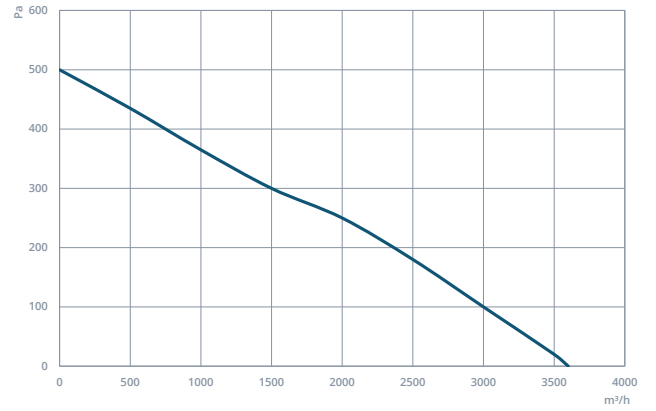

SHU 43

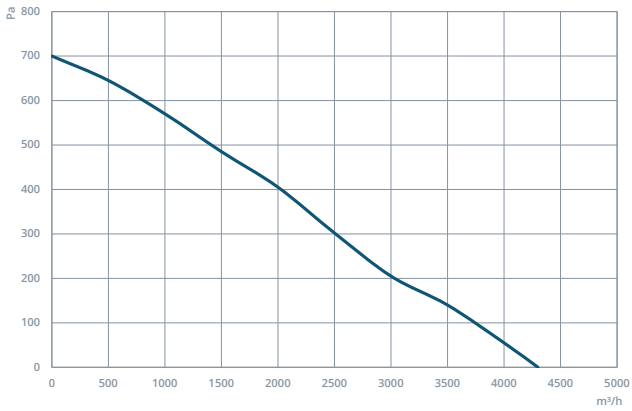

SHU 54

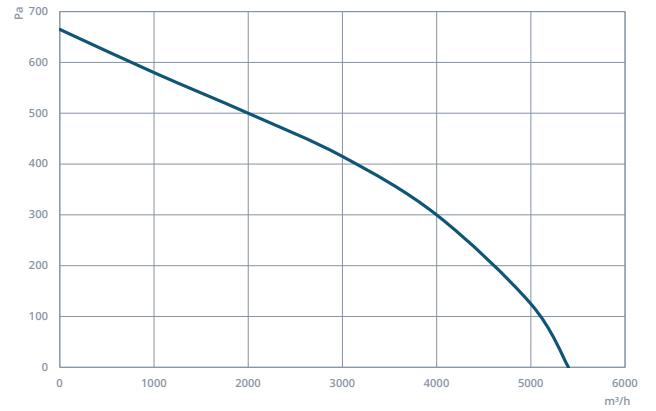

SHU 3E

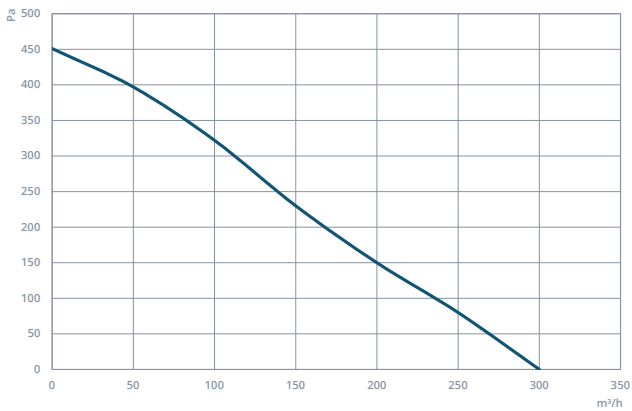

A photograph of a Japanese izakaya restaurant. In the foreground, a grill is cooking skewers, with a large plume of white steam rising from it. A red Mario figurine is placed on the counter. In the background, a person is visible behind the bar, and there are various glasses and dishes on the counter. The scene is lit with warm, yellowish light.

K **FILTRE**
KOKU
O **MONTAJ**
L
A **HAVA**
LAN
Y **DIRMA**

► FFU - Filtreli Fan

FFU standart olarak G4 Toz Tutucu Filtre ve Aktif Karbon koku tutucu filtre ile üretilir. Müşteri talebi doğrultusunda fanın filtreleri opsiyonel olarak değiştirilebilir. Bu sayede ihtiyaç duyulan uygulamaya göre şekillendirilebilir.



MOTOR YALITIM SINIFI	F SINIFI
MOTOR KORUMA SINIFI	IP 44
MOTOR VERİM SINIFI	-
MOTOR TİPİ	DIŞTAN ROTORLU MOTOR
MOTOR MARKASI	-
GÖVDE MALZEMESİ	GALVANİZE SAC
GÖVDE KAPLAMASI	YOK
PERVANE MALZEMESİ	ALÜMİNYUM
GÖREV DÖNGÜSÜ	IEC Duty Cycle-S1
ÇALIŞMA SICAKLIĞI	-20 - +50 °C
STANDARTLAR	IEC-60335-2-80, ISO 1940-1



MODEL	VOLTAJ (V)	FREKANS (Hz)	GÜÇ (W)	HIZ ANAHTARI MODELİ	DEVİR (d/dk)	DEBİ (m³/h)	SES SEVİYESİ (dB(A))	FİYAT (€/Adet)
FFU 5	230	50	85	KHA 2,5 A	2.722	665	50	200,00 €
FFU 10	230	50	122	KHA 2,5 A	2.670	950	52	239,00 €
FFU 20	230	50	210	KHA 2,5 A	2.580	1.665	54	303,00 €
FFU 30	230	50	380	KHA 2,5 A	1.420	3.230	56	659,00 €
FFU 40	230	50	690	KHA 2,5 A	1.365	4.655	58	935,00 €

Değerler 0 Pa içindir
HIZ ANAHTARI CİHAZ FİYATLARINA DAHİL DEĞİLDİR.

TEKNİK RESİM

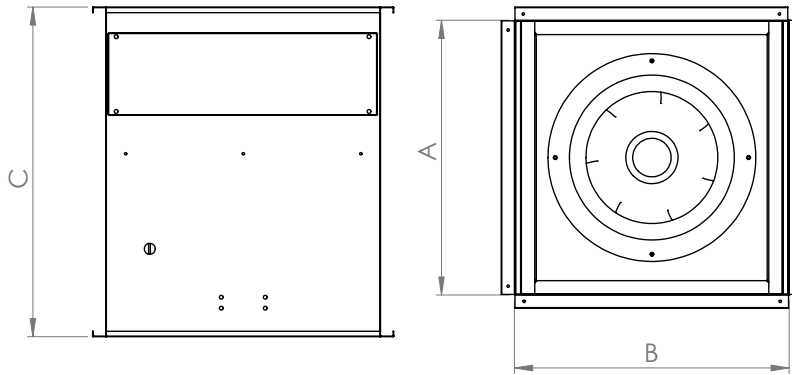

MODEL	A (mm)	B (mm)	C (mm)
FFU 5	300	300	500
FFU 10	350	350	500
FFU 20	400	400	500
FFU 30	450	450	600
FFU 40	500	500	600

PERFORMANS EĞRİLERİ

FFU 5

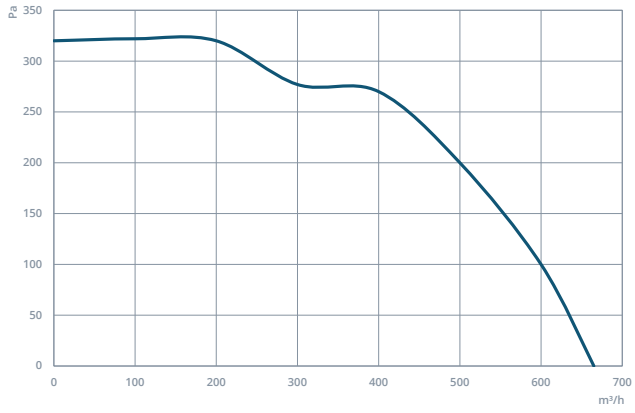

FFU 10

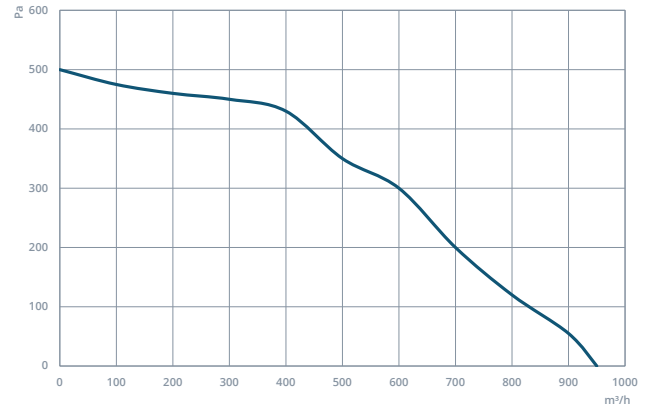

FFU 20

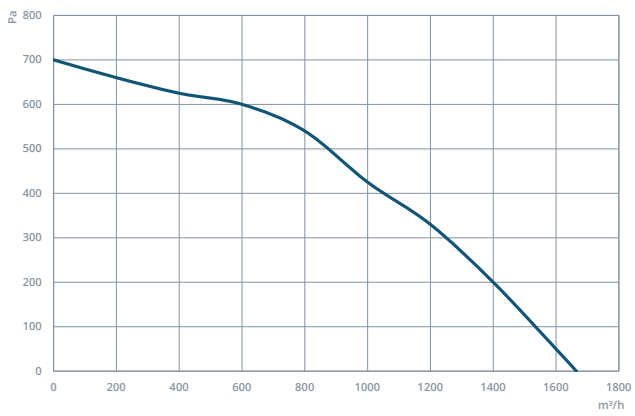

FFU 30

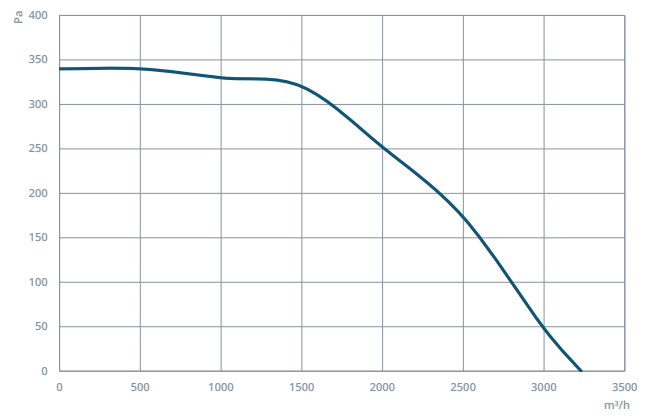

FFU 40

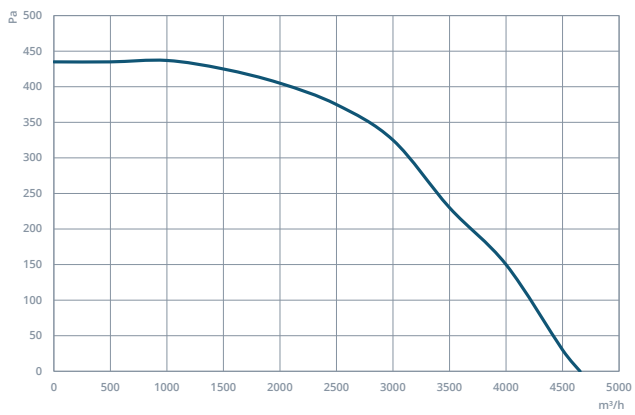

► FFUH - Hepa Filtreli Fan

FFUH bünyesinde bulunan G4, aktif karbon ve H13 HEPA filtresi ile kapalı alanlara verilen havanın toz, koku ve yabancı maddelerden arındırılmasını sağlar. By-pass damperi sayesinde hava sadece G4 filtreden geçirilebilir. Bu sayede HEPA filtrenin ömrü uzatılmış olur.



MOTOR YALITIM SINIFI	F SINIFI
MOTOR KORUMA SINIFI	IP 44
MOTOR VERİM SINIFI	-
MOTOR TİPİ	DIŞTAN ROTORLU MOTOR
MOTOR MARKASI	-
GÖVDE MALZEMESİ	GALVANİZE SAC
GÖVDE KAPLAMASI	YOK
PERVANE MALZEMESİ	ALÜMİNYUM
GÖREV DÖNGÜSÜ	IEC Duty Cycle-S1
ÇALIŞMA SICAKLIĞI	-20 - +50 °C
STANDARTLAR	IEC-60335-2-80, ISO 1940-1

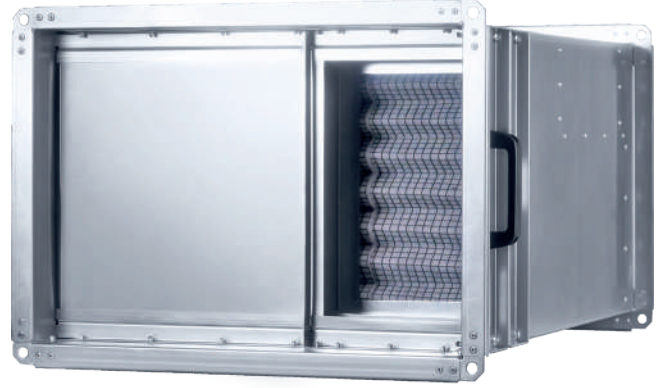

MODEL	VOLTAJ (V)	FREKANS (Hz)	GÜÇ (W)	DEVİR (d/dk)	DEBİ (m³/h)	SES SEVİYESİ (dB(A))	FİYAT (€/Adet)
FFUH 10	230	50	104	2.675	800	50	380,00 €
FFUH 20	230	50	130	2.685	1.500	52	440,00 €
FFUH 30	230	50	180	2.615	2.000	54	550,00 €
FFUH 40	230	50	380	1.365	3.500	56	855,00 €
FFUH 50	230	50	690	1.365	4.500	59	1.160,00 €

Değerler 0 Pa'da Fan Değerleridir.

TEKNİK RESİM

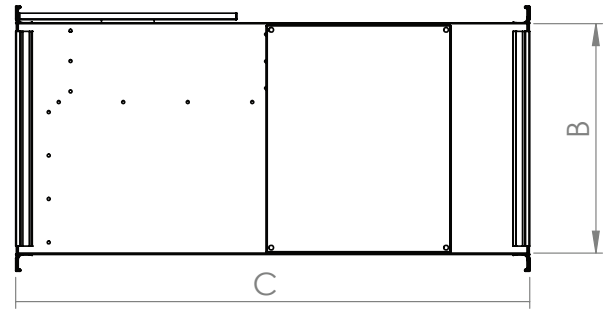
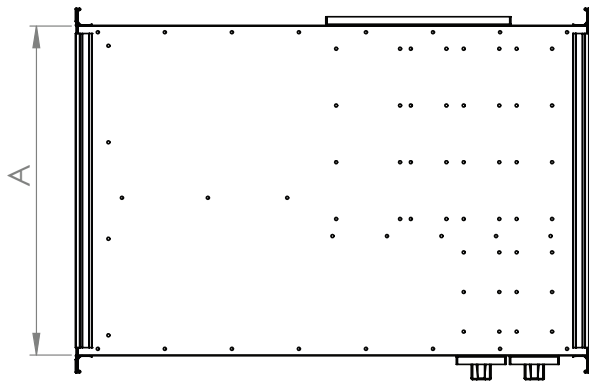

MODEL	A (mm)	B (mm)	C (mm)
FFUH 10	500	350	780
FFUH 20	500	350	800
FFUH 30	600	400	920
FFUH 40	975	400	1000
FFUH 50	975	400	1000

K PATOJEN
H HAREKET
O BAKIM

L

A HAVA
LAN
YDIRMA

► HTUY - Yer Tipi Hava Temizleme Ünitesi

Yer tipi hava temizleme üniteleri sahip oldukları H13 sınıfı HEPA filtreleri ile havadaki 300 nanometre (0,00003 cm) boyundaki virüs, bakteri, patojen ve diğer yabancı maddeleri dahi %99,97 oranında tutar. Önündeki G4 filtre HEPA filtrenin çabuk dolmasını engeller ve ömrünü uzatır.



MOTOR YALITIM SINIFI	F SINIFI
MOTOR KORUMA SINIFI	IP 44
MOTOR VERİM SINIFI	-
MOTOR TİPİ	DIŞTAN ROTORLU MOTOR
MOTOR MARKASI	-
GÖVDE MALZEMESİ	GALVANİZE SAC
GÖVDE KAPLAMASI	ELEKTRO-STATİK TOZ BOYA
PERVANE MALZEMESİ	ALÜMİNYUM
GÖREV DÖNGÜSÜ	IEC Duty Cycle-S1
ÇALIŞMA SICAKLIĞI	-20 - +50 °C
STANDARTLAR	IEC-60335-2-80, ISO 1940-1



MODEL	VOLTAJ (V)	FREKANS (Hz)	GÜÇ (W)	DEVİR (d/dk)	DEBİ (m ³ /h)	SES SEVİYESİ (dB(A))	FİYAT (€/Adet)
HTUY 457	230	50	104	2.675	340	43	910,00 €
HTUY 610	230	50	180	2.615	600	48	1.020,00 €

Değerler 0 Pa içindir

TEKNİK RESİM

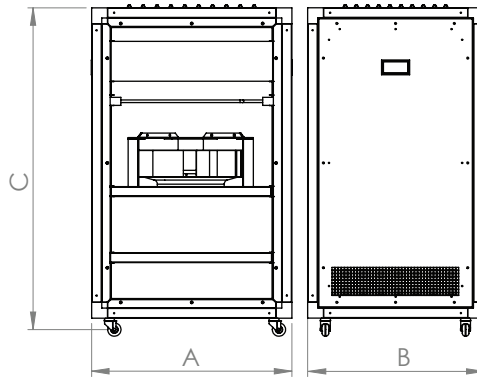

MODEL	A (mm)	B (mm)	C (mm)
HTUY 457	605	515	1225
HTUY 610	755	665	1225

K TAVAN
K PATOJEN
O BAKIM

L

A HAVA
LAN
Y DIRMA

► HTUT - Tavan Tipi Hava Temizleme Ünitesi

Tavan tipi hava temizleme üniteleri sahip oldukları H13 sınıfı HEPA filtreleri ile havadaki 300 nanometre (0,00003 cm) boyundaki virüs, bakteri, patojen ve diğer yabancı maddeleri dahi %99,97 oranında tutar. Önündeki G4 filtre HEPA filtrenin çabuk dolmasını engeller ve ömrünü uzatır.



MOTOR YALITIM SINIFI	F SINIFI
MOTOR KORUMA SINIFI	IP 44
MOTOR VERİM SINIFI	-
MOTOR TİPİ	DIŞTAN ROTORLU MOTOR
MOTOR MARKASI	-
GÖVDE MALZEMESİ	GALVANİZE SAC
GÖVDE KAPLAMASI	ELEKTRO-STATİK TOZ BOYA
PERVANE MALZEMESİ	ALÜMİNYUM
GÖREV DÖNGÜSÜ	IEC Duty Cycle-S1
ÇALIŞMA SICAKLIĞI	-20 - +50 °C
STANDARTLAR	IEC-60335-2-80, ISO 1940-1



MODEL	VOLTAJ (V)	FREKANS (Hz)	GÜÇ (kW)	DEVİR (d/dk)	DEBİ (m³/h)	SES SEVİYESİ (dB(A))	FİYAT (€/Adet)
HTUT 13	230	50	0,25	2.362	1.200	58	765,00 €

Değerler 0 Pa içindir

TEKNİK RESİM

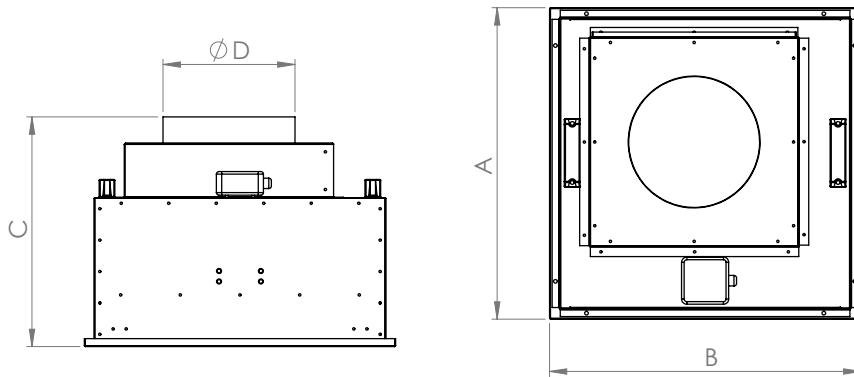

MODEL	A (mm)	B (mm)	C (mm)	D (mm)
HTUT 13	595	595	440	250

K HİJYEN
TEMİZLİK
O MONTAJ

L
A HAVA
Y DİRMA
L
A N
Y DİRMA



► HFFU - Hijyenik Filtreli Fan

HFFU'lar hastane, ilaç fabrikası gibi hijyen şartları gerektiren ortamların havalandırması için özel tasarlanmıştır. INOX gövdeye sahip fanlarda G4 Toz Tutucu Filtre ve HEPA Filtre bulunmaktadır.



MOTOR YALITIM SINIFI	F SINIFI
MOTOR KORUMA SINIFI	IP 44
MOTOR VERİM SINIFI	-
MOTOR TİPİ	DIŞTAN ROTORLU MOTOR
MOTOR MARKASI	-
GÖVDE MALZEMESİ	AISI 304
GÖVDE KAPLAMASI	YOK
PERVANE MALZEMESİ	ALÜMİNYUM
GÖREV DÖNGÜSÜ	IEC Duty Cycle-S1
ÇALIŞMA SICAKLIĞI	-20 - +50 °C
STANDARTLAR	IEC-60335-2-80, ISO 1940-1

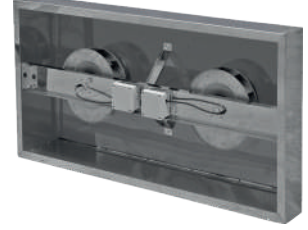
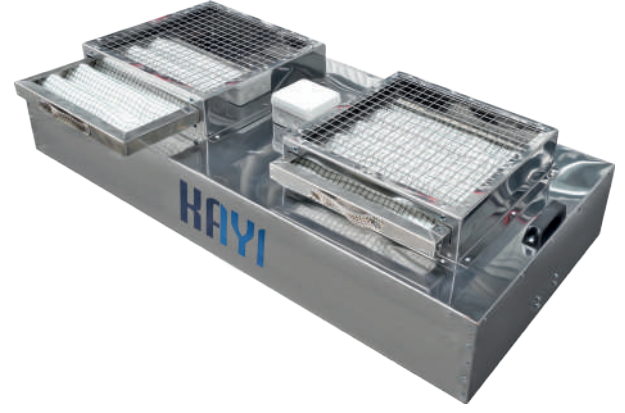

MODEL	VOLTAJ (V)	FREKANS (Hz)	GÜÇ (W)	DEVİR (d/dk)	DEBİ (m³/h)	SES SEVİYESİ (dB(A))	FİYAT (€/Adet)
HFFU 610-610	230	50	125	2.410	600	60	2.098,00 €
HFFU 610-1220	230	50	270	2.410	1.200	68	3.639,00 €

Değerler 0 Pa içindir

TEKNİK RESİM

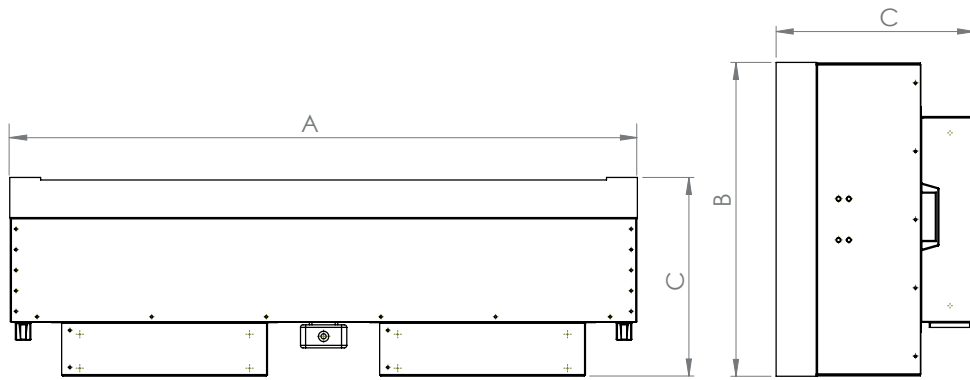

MODEL	A (mm)	B (mm)	C (mm)	D (mm)
HFFU 610-610	610	610	386	200
HFFU 610-1220	1220	610	386	200

K BANYO
B BUHAR
O MONTAJ

L

A HAVA
LAN
Y DIRMA

► BAF - Banyo Fanı

Yüksek kalite ABS plastik malzemeden imal edilen BAF fanlar banyo ve tuvalet havalandırmasında kullanılmak üzere tasarlanmıştır. Tavana montajı uygun değildir.



MOTOR YALITIM SINIFI	F SINIFI
MOTOR KORUMA SINIFI	IP 25
MOTOR VERİM SINIFI	-
MOTOR TİPİ	DIŞTAN ROTORLU MOTOR
MOTOR MARKASI	-
GÖVDE MALZEMESİ	ABS PLASTİK
GÖVDE KAPLAMASI	-
PERVANE MALZEMESİ	ABS PLASTİK
GÖREV DÖNGÜSÜ	IEC Duty Cycle-S1
ÇALIŞMA SICAKLIĞI	-20 - +50 °C
STANDARTLAR	IEC-60335-2-80, ISO 1940-1



MODEL	VOLTAJ (V)	FREKANS (Hz)	GÜÇ (W)	DEVİR (d/dk)	DEBİ (m³/h)	SES SEVİYESİ (dB(A))	FIYAT (€/Adet)
BAF 100	230	50	14	2.800	97	35	10,70 €
BAF 125	230	50	16	2.800	183	36	13,40 €
BAF 150	230	50	16	2.800	290	38	18,80 €

Değerler 0 Pa içindir

KLAPELİ MODEL	VOLTAJ (V)	FREKANS (Hz)	GÜÇ (W)	DEVİR (d/dk)	DEBİ (m³/h)	SES SEVİYESİ (dB(A))	KLAPELİ FİYAT (€/Adet)
BAF 100K	230	50	14	2.800	97	35	13,70 €
BAF 125K	230	50	16	2.800	183	36	17,40 €
BAF 150K	230	50	16	2.800	290	38	23,80 €

Değerler 0 Pa içindir

TEKNİK RESİM

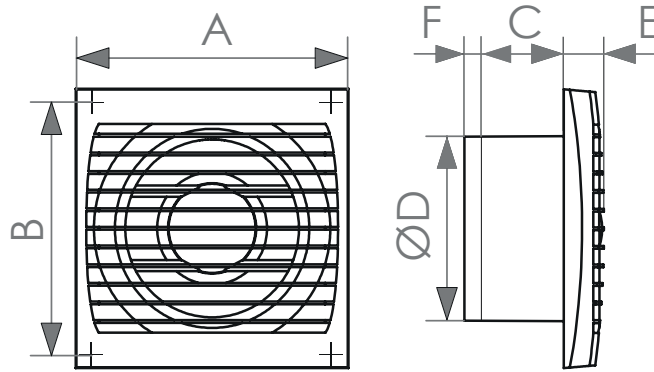

MODEL	A (mm)	B (mm)	C (mm)	D (mm)	E (mm)	F (mm) Klapeli Ölçüsü
BAF 100	150	135	55	100	22	7
BAF 125	175	160	61	125	23	8,5
BAF 150	200	185	62	150	24	10

PERFORMANS EĞRİLERİ

BAF 100

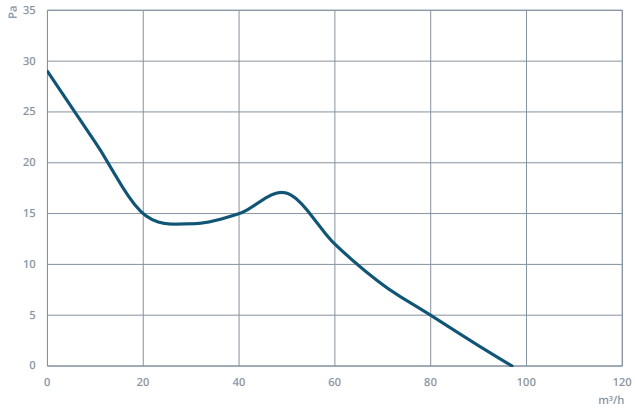

BAF 125

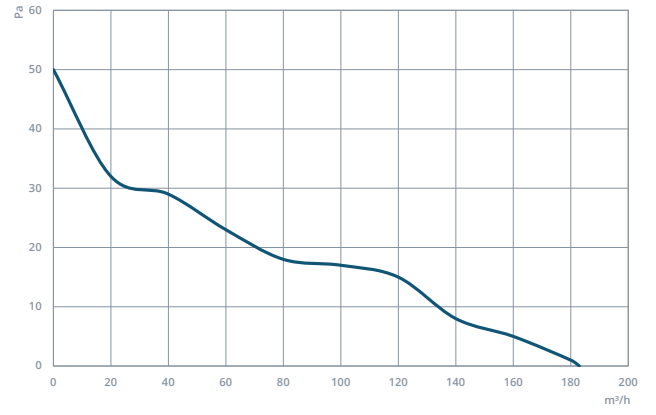

BAF 150

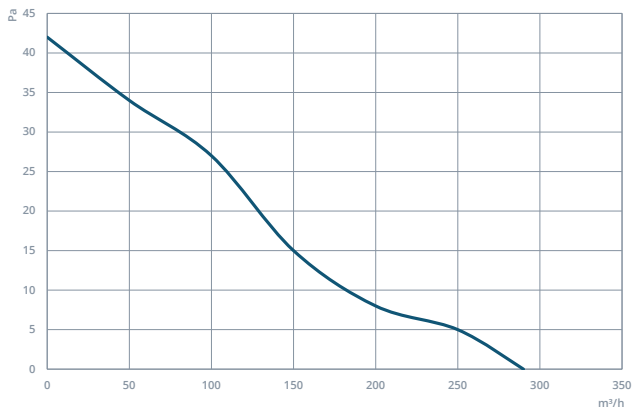

► SEF - Sessiz Banyo Fanı

Yüksek kalite ABS plastik malzemeden imal edilen SEF fanlar banyo ve tuvalet havalandırmasında kullanılmak üzere tasarlanmıştır. Düşük ses seviyesi sayesinde kullanımı sırasında rahatsızlık vermez.



MOTOR YALITIM SINIFI	F SINIFI
MOTOR KORUMA SINIFI	IP 25
MOTOR VERİM SINIFI	-
MOTOR TİPİ	DIŞTAN ROTORLU MOTOR
MOTOR MARKASI	-
GÖVDE MALZEMESİ	ABS PLASTİK
GÖVDE KAPLAMASI	-
PERVANE MALZEMESİ	ABS PLASTİK
GÖREV DÖNGÜSÜ	IEC Duty Cycle-S1
ÇALIŞMA SICAKLIĞI	+40 °C
STANDARTLAR	IEC-60335-2-80, ISO 1940-1



MODEL	VOLTAJ (V)	FREKANS (Hz)	GÜÇ (W)	DEVİR (d/dk)	DEBİ (m³/h)	SES SEVİYESİ (dB(A))	FIYAT (€/Adet)
SEF 100	230	50	8,4	2.800	90	25	40,00 €
SEF 125	230	50	10	2.800	180	30	52,00 €
SEF 150	230	50	20	2.800	320	33	93,00 €

Değerler 0 Pa içindir

TEKNİK RESİM

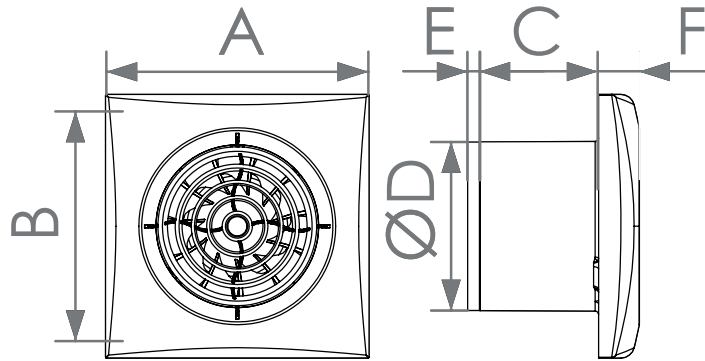

MODEL	A (mm)	B (mm)	C (mm)	D (mm)	E (mm) Klapa Ölçüsü	F (mm)
SEF 100	155	135	70	98	7	24
SEF 125	175	155	78	123	8,5	24
SEF 150	205	183	108	149	-	24

PERFORMANS EĞRİLERİ

SEF 100

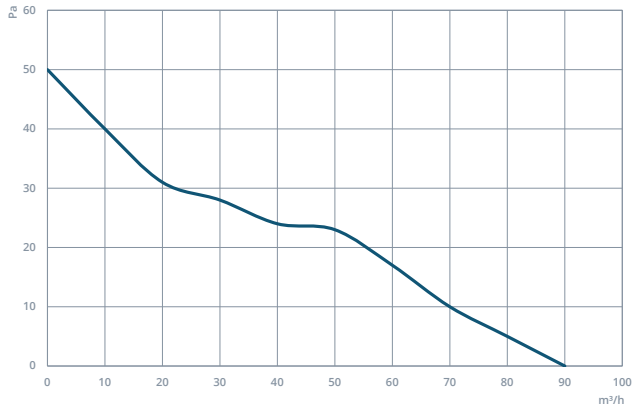

SEF 125

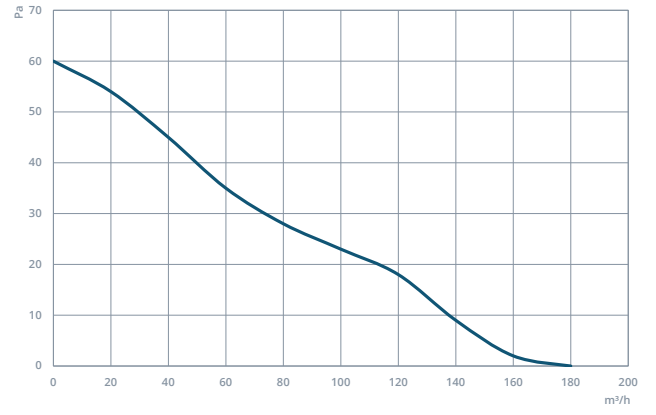

SEF 150

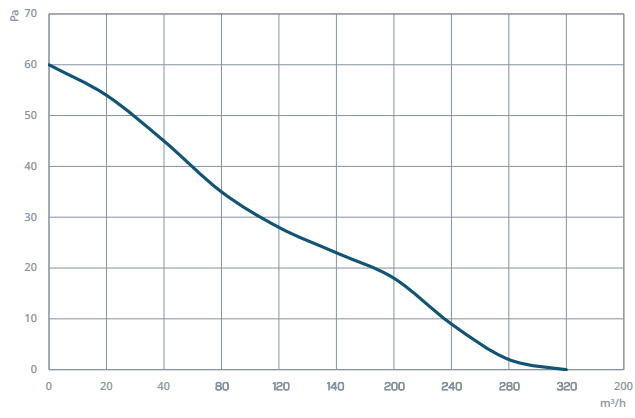

► YUF - Yuvarlak Banyo Fanı

Yüksek kalite ABS plastik malzemeden imal edilen YUF fanlar banyo ve tuvalet havalandırmasında kullanılmak üzere tasarlanmıştır.



MOTOR YALITIM SINIFI	F SINIFI
MOTOR KORUMA SINIFI	IP 25
MOTOR VERİM SINIFI	-
MOTOR TİPİ	DIŞTAN ROTORLU MOTOR
MOTOR MARKASI	-
GÖVDE MALZEMESİ	ABS PLASTİK
GÖVDE KAPLAMASI	-
PERVANE MALZEMESİ	ABS PLASTİK
GÖREV DÖNGÜSÜ	IEC Duty Cycle-S1
ÇALIŞMA SICAKLIĞI	-20 - +50 °C
STANDARTLAR	IEC-60335-2-80, ISO 1940-1



MODEL	VOLTAJ (V)	FREKANS (Hz)	GÜÇ (W)	DEVİR (d/dk)	DEBİ (m³/h)	SES SEVİYESİ (dB(A))	FİYAT (€/Adet)
YUF 100	230	50	14	2.800	107	35	10,70 €
YUF 125	230	50	18	2.800	190	36	13,40 €
YUF 150	230	50	22	2.800	300	38	18,80 €

Değerler 0 Pa içindir

KLAPELİ MODEL	VOLTAJ (V)	FREKANS (Hz)	GÜÇ (W)	DEVİR (d/dk)	DEBİ (m³/h)	SES SEVİYESİ (dB(A))	KLAPELİ FİYAT (€/Adet)
YUF 100K	230	50	14	2.800	107	35	13,70 €
YUF 125K	230	50	18	2.800	190	36	17,40 €
YUF 150K	230	50	22	2.800	300	38	23,80 €

Değerler 0 Pa içindir

TEKNİK RESİM

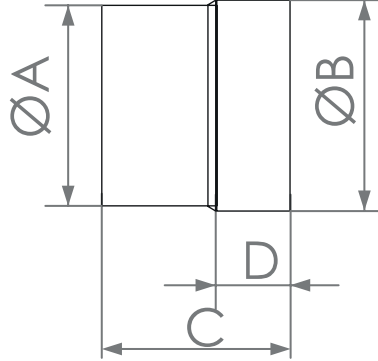
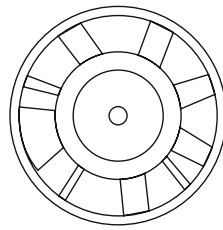

Klapeli modellerde, klape ürünün içerisindedir.

MODEL	A (mm)	B (mm)	C (mm)	D (mm)
YUF 100	100	103	80	30
YUF 125	125	128	87	30
YUF 150	150	153	101	35

PERFORMANS EĞRİLERİ

YUF 100

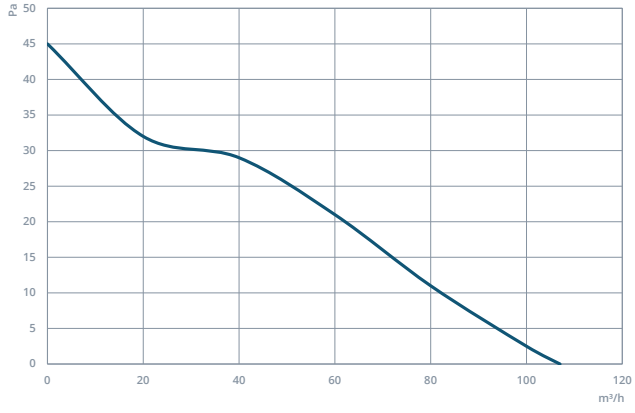

YUF 125

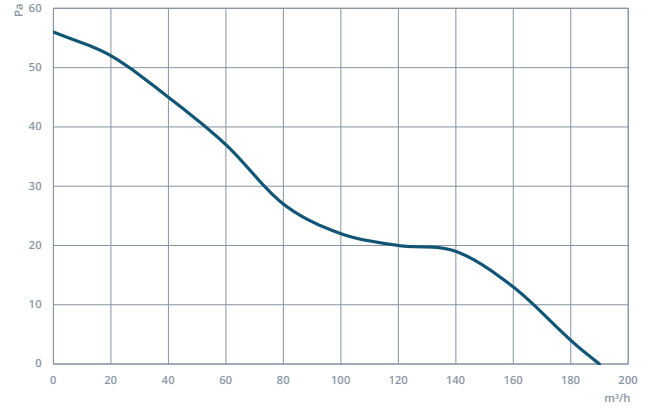

YUF 150

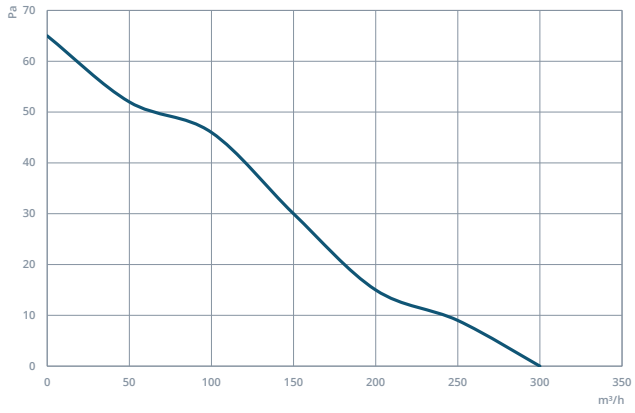

► Fan Kontrol Cihazları

Monofaze Hız Anahtarı

Kayı marka hız anahtarları monofaze Kayı ürünlerinde deviri ayarlamak için kullanılabilir.



MODEL	FİYAT (€/Adet)
KHA 2,5 A	45,00 €
KHA 5,0 A	55,00 €
KHA 7,5 A	77,00 €
KHA 10,0 A	127,00 €

Trifaze Frekans Konvertörü



Hız anahtarları trifaze Kayı ürünlerinde deviri ayarlamak için kullanılabilir. İsteğe bağlı olarak monofaze elektrikle trifaze motoru çalıştırmak için modellerde kullanılabilir. Fiyatlara Keypad dahildir.

MODEL	FİYAT (€/Adet)
0,55 kW	526,00 €
0,75 kW	526,00 €
1,10 kW	601,00 €
1,50 kW	677,00 €
2,20 kW	764,00 €
3,00 kW	870,00 €
4,00 kW	962,00 €
5,50 kW	1.150,00 €
7,50 kW	1.322,00 €
11,00 kW	1.362,00 €
15,00 kW	1.776,00 €
18,50 kW	2.221,00 €
22,00 kW	2.687,00 €
30,00 kW	3.292,00 €
37,00 kW	4.010,00 €
45,00 kW	4.883,00 €



KM

Kendinden Motorlu
Radyal Fan

Ø180 ile Ø560 Arası Ölçülerde
520 m³/h ile 9.300 m³/h Arası Debilerde

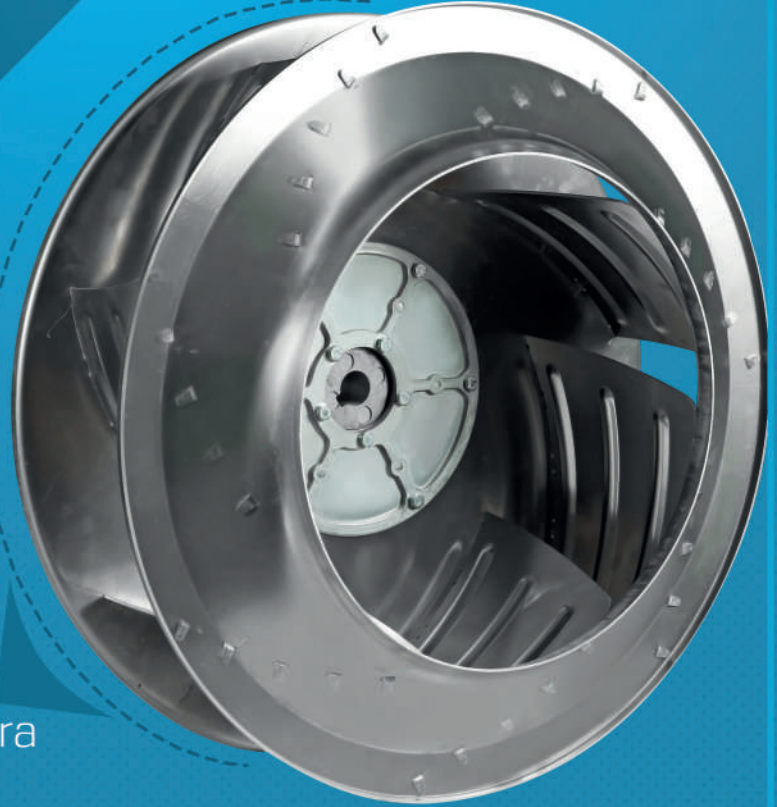

K

Asenkron Motorlara
Akuple Fan

Ø280 ile Ø710 Arası Ölçülerde
1.100 m³/h ile 14.000 m³/h Arası Debilerde

OEM ÜRÜNLER İÇİN FİYAT SORUNUZ

► SER - Sera Fanı

Sera fanları her türlü seranın havalandırması için kullanılabilir.



MOTOR YALITIM SINIFI	F SINIFI
MOTOR KORUMA SINIFI	IP 55
MOTOR VERİM SINIFI	IE2-IE3
MOTOR TİPİ	TEFC
MOTOR MARKASI	-
GÖVDE MALZEMESİ	GALVANİZE SAC
GÖVDE KAPLAMASI	YOK
PERVANE MALZEMESİ	GALVANİZE SAC
GÖREV DÖNGÜSÜ	IEC Duty Cycle-S1
ÇALIŞMA SICAKLIĞI	-20 - +50 °C
STANDARTLAR	IEC-60335-2-80, ISO 1940-1



MODEL	VOLTAJ (V)	FREKANS (Hz)	GÜÇ (kW)	DEVİR (d/dk)	DEBİ (m ³ /h)	SES SEVİYESİ (dB(A))
SER 350	230	50	180	1.365	4.100	73
SER 400	230	50	250	1.365	5.890	73
SER 500	230	50	250	1.365	7.400	75
SER 600	230	50	370	1.365	8.900	78

Değerler 0 Pa içindir

TEKNİK RESİM

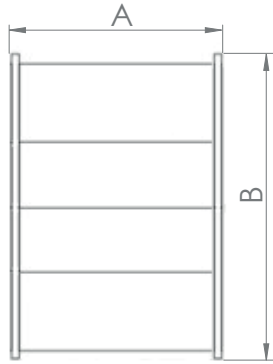

MODEL	A (mm)	B (mm)
SER 350	360	500
SER 400	410	500
SER 500	510	500
SER 600	610	500

► TAV - Çiftlik Fanı



TAV fanlar her türlü çiftlik, kümes, ahır ve ağır havalandırması için kullanılabilir



MOTOR YALITIM SINIFI	F SINIFI
MOTOR KORUMA SINIFI	IP 55
MOTOR VERİM SINIFI	IE2-IE3
MOTOR TİPİ	TEFC
MOTOR MARKASI	-
GÖVDE MALZEMESİ	GALVANİZE SAC
GÖVDE KAPLAMASI	YOK
PERVANE MALZEMESİ	GALVANİZE SAC
GÖREV DÖNGÜSÜ	IEC Duty Cycle-S1
ÇALIŞMA SICAKLIĞI	-20 - +50 °C
STANDARTLAR	IEC-60335-2-80,ISO 1940-1

MODEL	VOLTAJ (V)	FREKANS (Hz)	GÜÇ (kW)	DEVİR (d/dk)	DEBİ (m³/h)	SES SEVİYESİ (dB(A))
TAV 100	380	50	0,37	610	22.500	63
TAV 140	380	50	1.10	439	44.500	65

Değerler 0 Pa içindir

TEKNİK RESİM

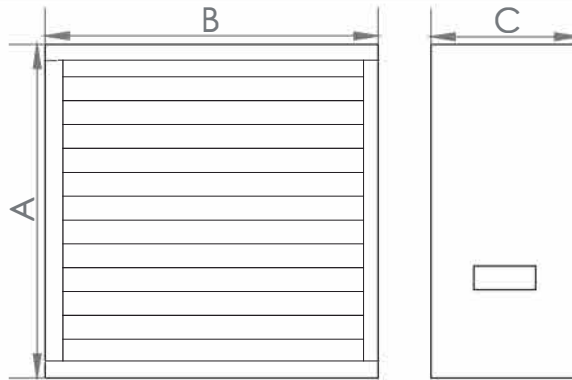

MODEL	A (mm)	B (mm)	C (mm)
TAV 100	960	960	400
TAV 140	1390	1390	400

MOTOR

0,18 kW ile 45 kW Arası



GÖVDE

Ø315 ile Ø1120 Arası

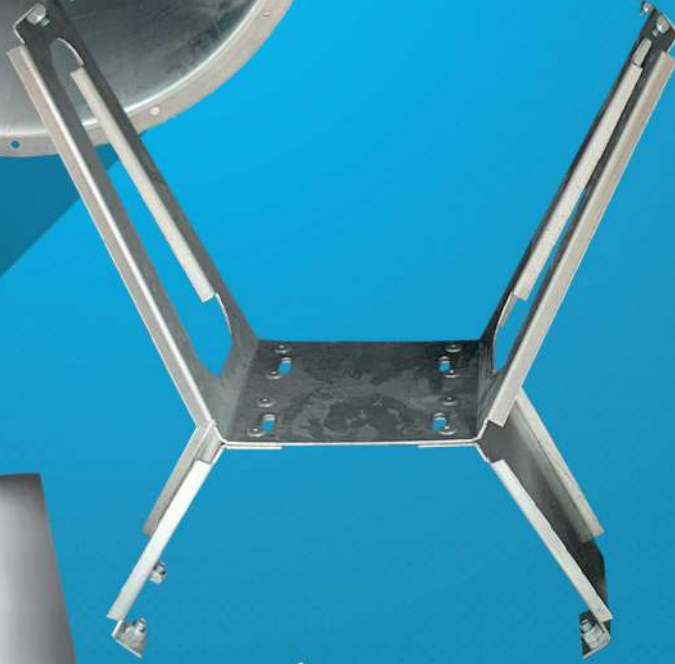

AYAK

0,18 kW ile 45 kW Arası Motorlar İçin



PERVANE

Ø315 ile Ø1250 Arası 5, 8, 12, 16 Kanat Adedi
Plastik veya Alüminyum

OEM ÜRÜNLER İÇİN FİYAT SORUNUZ

► Gemici Anemostadlar

Plastik Gemici Anemostad

BOĞAZ ÖLÇÜSÜ (mm)	DEBİ (m ³ /h)	FİYAT (\$/Adet)
100	120	5,60 \$
125	175	6,00 \$
150	250	6,80 \$



Işıklı Plastik Gemici Anemostad

BOĞAZ ÖLÇÜSÜ (mm)	DEBİ (m ³ /h)	FİYAT (\$/Adet)
100	120	18,10 \$



Susturucu

Prizmatik Kanal Tipi Susturucu



EN\BOY	200 mm	300 mm	400 mm	500 mm	600 mm	700 mm	800 mm
200 mm	74,00 €	78,00 €	98,00 €	104,00 €	126,00 €	137,00 €	170,00 €
300 mm	78,00 €	81,00 €	104,00 €	111,00 €	137,00 €	149,00 €	185,00 €
400 mm	98,00 €	104,00 €	111,00 €	137,00 €	149,00 €	185,00 €	195,00 €
500 mm	104,00 €	111,00 €	137,00 €	149,00 €	185,00 €	195,00 €	209,00 €
600 mm	126,00 €	137,00 €	149,00 €	185,00 €	195,00 €	209,00 €	231,00 €
700 mm	137,00 €	149,00 €	185,00 €	195,00 €	209,00 €	231,00 €	270,00 €
800 mm	170,00 €	185,00 €	195,00 €	209,00 €	231,00 €	270,00 €	290,00 €
900 mm	185,00 €	195,00 €	209,00 €	231,00 €	270,00 €	290,00 €	312,00 €
1000 mm	221,00 €	234,00 €	254,00 €	270,00 €	290,00 €	312,00 €	336,00 €
1200 mm	264,00 €	277,50 €	297,00 €	309,00 €	332,00 €	351,00 €	371,00 €

FİYATLAR €/ADET OLARAK VERİLMİŞTİR. SUSTURUCULARIN BOYU 500 MM'DİR. DİĞER BOYLAR İÇİN FİYAT SORUNUZ.

Yuvarlak Kanal Tipi Susturucu



ÇAP (mm)	UZUNLUK (mm)	FİYAT (€/Adet)
100	500	74,00 €
125	500	81,00 €
150	500	87,00 €
200	500	101,00 €
250	500	120,00 €
315	500	140,00 €
355	1000	297,00 €
400	1000	315,00 €
450	1000	365,00 €

ÇAP (mm)	UZUNLUK (mm)	FİYAT (€/Adet)
500	1000	395,00 €
560	1000	447,00 €
630	1000	478,00 €
710	1000	550,00 €
800	1000	623,00 €
900	1000	701,00 €
1000	1000	777,00 €
1120	1000	872,00 €
1250	1000	972,00 €

► QCM-ATX - Duvar Tipi Aksiyel ATEX Fan



MOTOR YALITIM SINIFI	F SINIFI
MOTOR KORUMA SINIFI	IP 55
MOTOR VERİM SINIFI	-
MOTOR TİPİ	-
MOTOR MARKASI	-
GÖVDE MALZEMESİ	GALVANİZE SAC
GÖVDE KAPLAMASI	-
PERVANE MALZEMESİ	ALÜMİNYUM
GÖREV DÖNGÜSÜ	IEC Duty Cycle-S1
ÇALIŞMA SICAKLIĞI	-20 - +50 °C
STANDARTLAR	-



MODEL	VOLTAJ (V)	FREKANS (Hz)	GÜÇ (kW)	DEBİ (m³/h)	SES SEVİYESİ (dB(A))
QCM-ATX 314	380	50	0,09	2.125	69
QCM-ATX 354	380	50	0,12	3.200	73
QCM-ATX 404	380	50	0,18	3.100	74
QCM-ATX 454	380	50	0,37	6.800	83
QCM-ATX 564	380	50	0,75	11.500	89

Değerler 0 Pa içindir

TEKNİK RESİM

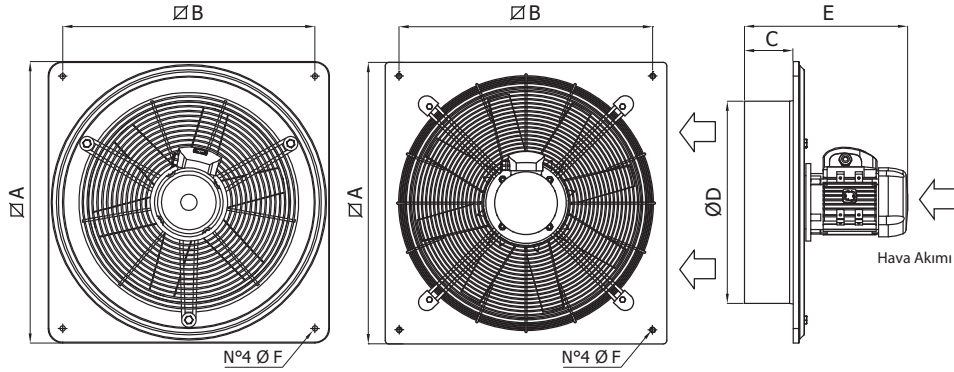

MODEL	A (mm)	B (mm)	C (mm)	D (mm)	E (mm)	F (mm)
QCM-ATX 314	465	405	77	312	285	10
QCM-ATX 354	525	465	90	365	315	10
QCM-ATX 404	580	520	100	413	325	10
QCM-ATX 454	630	570	107	457	370	10
QCM-ATX 564	765	695	122	569	385	10

PERFORMANS EĞRİLERİ

QCM-ATX 314

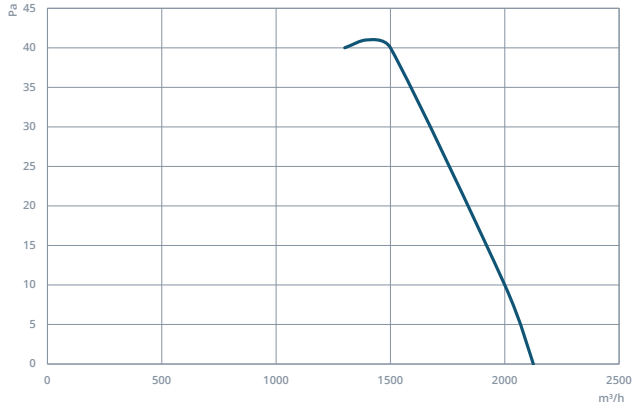

QCM-ATX 354

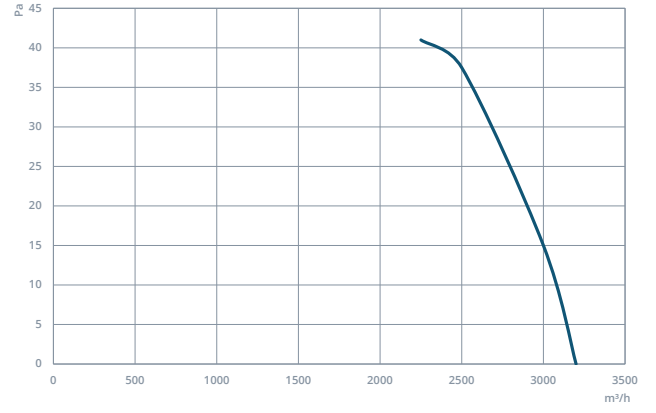

QCM-ATX 404

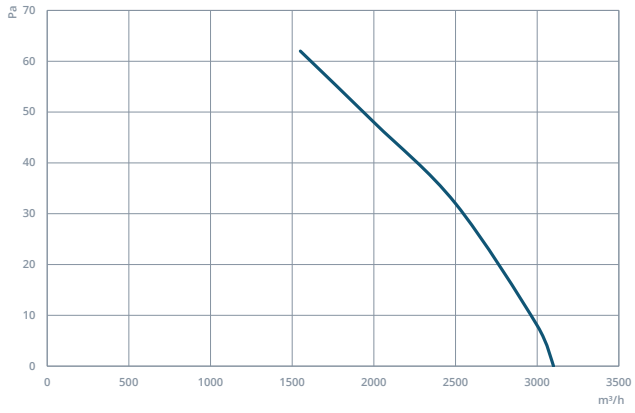

QCM-ATX 454

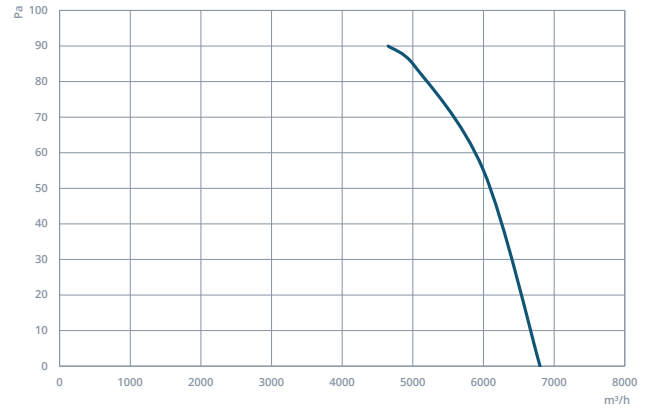

QCM-ATX 564

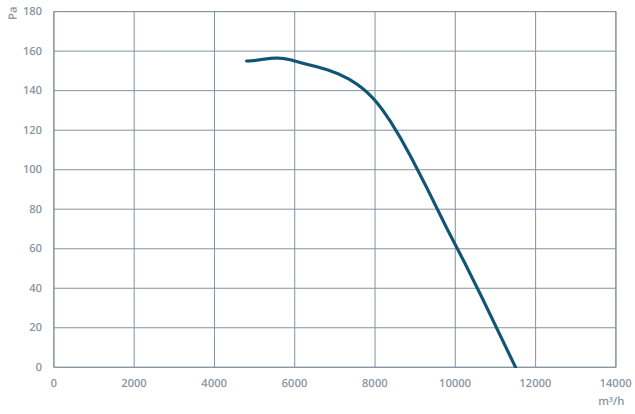

► ERM-EX - Kanal Tipi Plastik ATEX Fan

ERM-EX fanlar piyasada bulunan ATEX sınıfı tek karma akışlı fan serisidir. Kıvılcım çıkartmayan plastik malzemeden üretilmişlerdir.



MOTOR YALITIM SINIFI	B SINIFI
MOTOR KORUMA SINIFI	IP 54
MOTOR VERİM SINIFI	-
MOTOR TİPİ	-
MOTOR MARKASI	-
GÖVDE MALZEMESİ	PLASTİK
GÖVDE KAPLAMASI	-
PERVANE MALZEMESİ	PLASTİK
GÖREV DÖNGÜSÜ	IEC Duty Cycle-S1
ÇALIŞMA SICAKLIĞI	-20 - +50 °C
STANDARTLAR	-



MODEL	VOLTAJ (V)	FREKANS (Hz)	GÜÇ (kW)	DEVİR (d/dk)	DEBİ (m³/h)	SES SEVİYESİ (dB(A))
ERM-EX 18	230	50	0,06	2.760	290	66
ERM-EX 22	230	50	0,20	2.850	550	73
ERM-EX 25	230	50	0,30	2.890	900	77

Değerler 0 Pa içindir

TEKNİK RESİM

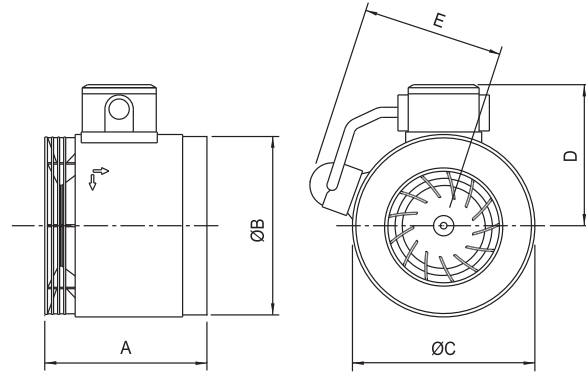

MODEL	A (mm)	B (mm)	C (mm)	D (mm)	E (mm)
ERM-EX 18	161	175	180	137	140
ERM-EX 22	175	221	230	165	165
ERM-EX 25	205	245	255	178	180

PERFORMANS EĞRİLERİ

ERM-EX 18

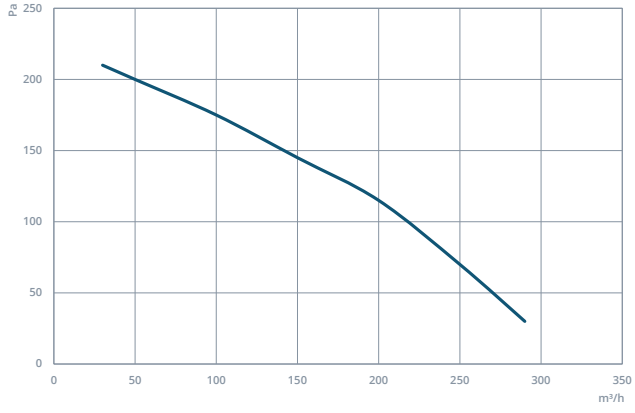

ERM-EX 22

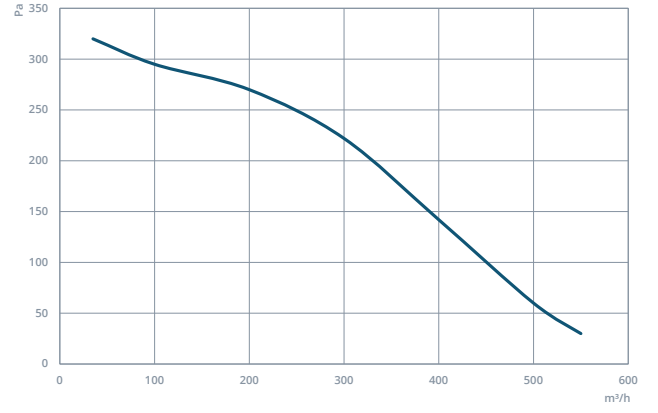

ERM-EX 25

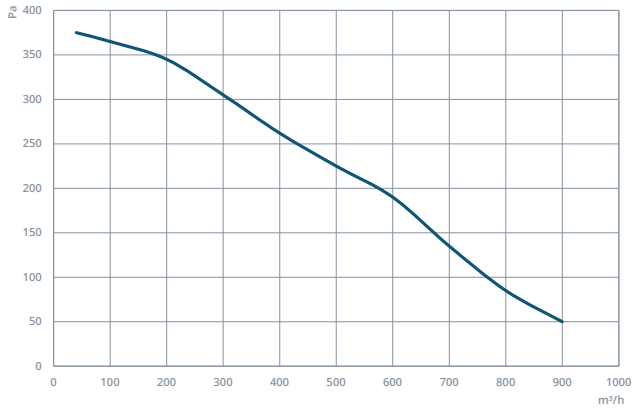

► VITRO - Cam Tipi Panjurlu Fan

Vitro'lar pencereye montajlanma özelliği ile ev ve ticari kullanım için uygundur.



BASINÇLANDIRMA



EGZÖZ



DUVARA MONTE



MOTOR HAVA AKIMININ İÇİNDE



MOTOR YALITIM SINIFI	-
MOTOR KORUMA SINIFI	IP X4
MOTOR VERİM SINIFI	-
MOTOR TİPİ	-
MOTOR MARKASI	-
GÖVDE MALZEMESİ	PLASTİK
GÖVDE KAPLAMASI	-
PERVANE MALZEMESİ	PLASTİK
GÖREV DÖNGÜSÜ	IEC Duty Cycle-S1
ÇALIŞMA SICAKLIĞI	-20 - +50 °C
STANDARTLAR	-



MODEL	VOLTAJ (V)	FREKANS (Hz)	GÜÇ (W)	DEBİ (m³/h)	SES SEVİYESİ (dB(A))
VITRO 6/150	230	50	40	300	48
VITRO 9/230	230	50	43	700	50
VITRO 9/230TD	230	50	46	700/400	50
VITRO 12/300	230	50	84	1.400	59
VITRO 12/300TD	230	50	84	1.400/800	59

Değerler 0 Pa içindir. TD Modellerde Hız Anahtarı Fiyata Dahildir.

TEKNİK RESİM

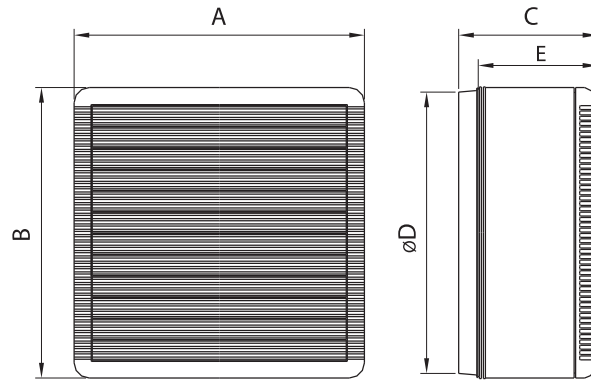

MODEL	A (mm)	B (mm)	C (mm)	D (mm)	E (mm)
VITRO 6/150	195	195	126	184:188	102
VITRO 9/230	287	287	138	254:258	122
VITRO 12/230	364	364	162	324:329	137

► SAF - Asitli Ortam Fanı

SAF fanlar asidik ve korozif ortamlarda çalışmak için tasarlanmıştır.



MOTOR YALITIM SINIFI	F SINIFI
MOTOR KORUMA SINIFI	IP 55
MOTOR VERİM SINIFI	-
MOTOR TIPI	-
MOTOR MARKASI	-
GÖVDE MALZEMESİ	PLASTİK
GÖVDE KAPLAMASI	-
PERVANE MALZEMESİ	PLASTİK
GÖREV DÖNGÜSÜ	IEC Duty Cycle-S1
ÇALIŞMA SICAKLIĞI	-20 - +50 °C
STANDARTLAR	-

MODEL	VOLTAJ (V)	FREKANS (Hz)	GÜÇ (kW)	DEVİR (d/dk)	DEBİ (m³/h)	SES SEVİYESİ (dB(A))
SAF 15	380	50	0,37	2.870	870	70
SAF 20	380	50	1,10	2.870	2.000	83
SAF 25	380	50	2,20	2.870	3.450	87
SAF 30	380	50	1,10	1.450	4.850	78
SAF 35	380	50	5,50	1.450	10.500	76

SAF 15

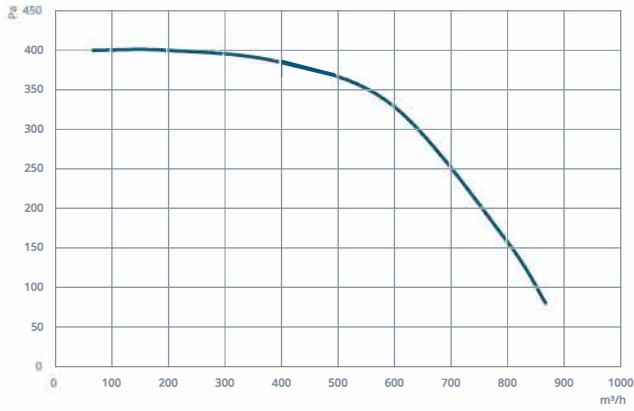

SAF 20-25

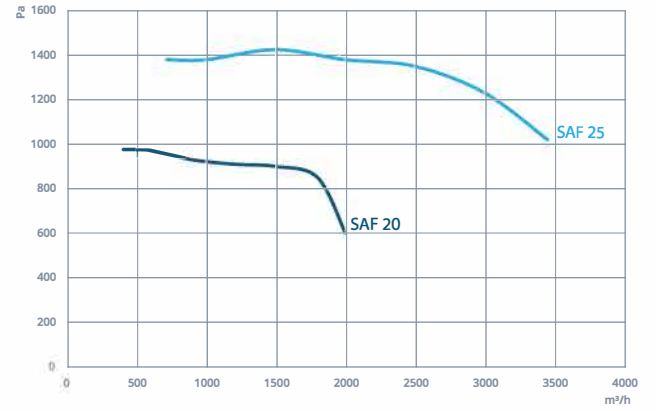

SAF 30

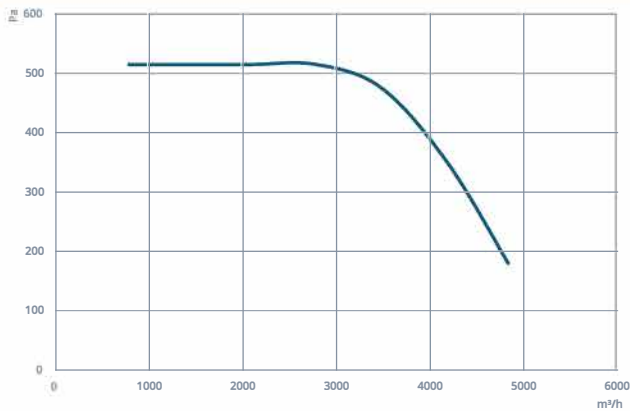

SAF 35

